

## Errata

**Title & Document Type:** 8349B Microwave Amplifier Operating and Service Manual

**Manual Part Number:** 08349-90017

**Revision Date:** April 1991

---

### HP References in this Manual

This manual may contain references to HP or Hewlett-Packard. Please note that Hewlett-Packard's former test and measurement, semiconductor products and chemical analysis businesses are now part of Agilent Technologies. We have made no changes to this manual copy. The HP XXXX referred to in this document is now the Agilent XXXX. For example, model number HP8648A is now model number Agilent 8648A.

### About this Manual

We've added this manual to the Agilent website in an effort to help you support your product. This manual provides the best information we could find. It may be incomplete or contain dated information, and the scan quality may not be ideal. If we find a better copy in the future, we will add it to the Agilent website.

### Support for Your Product

Agilent no longer sells or supports this product. You will find any other available product information on the Agilent Test & Measurement website:

[www.tm.agilent.com](http://www.tm.agilent.com)

Search for the model number of this product, and the resulting product page will guide you to any available information. Our service centers may be able to perform calibration if no repair parts are needed, but no other support from Agilent is available.

# OPERATING AND SERVICE MANUAL

## HP 8349B MICROWAVE AMPLIFIER

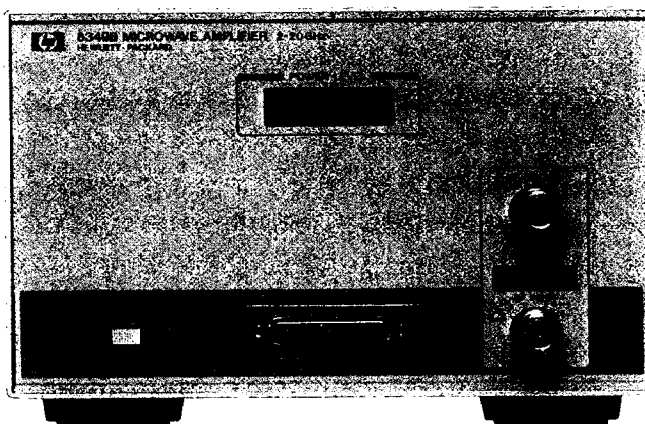

 **HEWLETT  
PACKARD**

# HP 8349B MICROWAVE AMPLIFIER

## SERIAL NUMBERS

This manual applies directly to HP 8349B microwave amplifiers having serial number prefix 3205A or 3130A.

For additional information about serial numbers, refer to "Instruments Covered By Manual" in section 1.

Using the information provided in Section 7, this manual applies to instruments with serial prefix 2644A, 2627A, 2548A, and 2513A.

©Copyright                      HEWLETT-PACKARD COMPANY                      1985  
1400 FOUNTAINGROVE PARKWAY, SANTA ROSA, CA 95403 U.S.A.

MANUAL PART NO. 08349-90017

Printed: JANUARY 1992  
EDITION 3



**HEWLETT  
PACKARD**

# TABLE OF CONTENTS

## SECTION 1. GENERAL INFORMATION

Introduction	1-1
Manual Organization	1-1
Instruments Covered by Manual	1-1
Serial Numbers	1-1
Instrument Description	1-2
Specifications	1-2
Equipment Available	1-5
Options	1-5
Rack Mounting Kits and Cabinet Accessories	1-5
Recommended Test Equipment and Accessories	1-5

## SECTION 2. INSTALLATION

Introduction	2-1
Initial Inspection	2-1
Safety Considerations	2-1
Preparation for Use	2-1
Power Requirements	2-1
Line Voltage and Fuse Selection	2-2
Replacement of Fuse	2-3
Power Cable	2-3
Operating Environment	2-3
Storage and Shipment	2-3
Environment	2-3
Packaging	2-3
Returning for Service	2-4

## SECTION 3. OPERATION

Introduction	3-1
Operator's Check	3-1
Rack Mounted Operation	3-1
Applications	3-1
Operator's Check	3-2
Power Amplifier	3-2
Wideband Preamplifier	3-3
Dedicated HP Millimeter-Wave Source	
Module Driver	3-5
Panel Features	3-8

## SECTION 4. PERFORMANCE TESTS

Introduction	4-1
Equipment Required	4-1
Operation Verification	4-1
Test Record	4-1
Output Power, Gain, and Flatness	4-2
VSWR	4-9
Spectral Purity	4-15

## SECTION 5. ADJUSTMENTS

Introduction	5-1
Safety Considerations	5-1
Equipment Required	5-1
Related Adjustments	5-2
Power Supply Adjustments	5-3
Initial Setup for Compensation Zero, Display, Exponential, and Dual Slope Log Adjustments	5-5
Compensation Zero Adjustment	5-6
Display Adjustment	5-7
Exponential Adjustment	5-8
Dual Slope Log Adjustments	5-9
Flatness Compensation Adjustments	5-13

## SECTION 6. REPLACEABLE PARTS

Introduction	6-1
Exchange Assemblies	6-1
Abbreviations	6-1
Replaceable Parts List	6-1
Ordering Information	6-2
Spare Parts Kit	6-2

## SECTION 7. MANUAL BACKDATING CHANGES

Introduction	7-1
--------------	-----

## SECTION 8. SERVICE

Introduction	8-1
Caution Notes	8-1
Schematic Diagram Symbols and Terms	8-1
Service Aids	8-1
Theory of Operation	8-1
Troubleshooting	8-2
Recommended Test Equipment	8-2
Troubleshooting Equipment	8-2
General Maintenance	8-2
Microcircuit	8-2
Rigid Cables	8-2
Repairs and the Circuit Boards	8-3
Printed Circuit Board Markings	8-3
HP 8349B Overall Description	8-5
A1 Display Board	8-9
A2 Amplifier and A3 Bias Board	8-19
A4 Signal Conditioning Board	8-27
A5 Regulator Board	8-37
A6 Motherboard	8-47
Module/Synthesizer Interface	8-47

## SAFETY CONSIDERATIONS

### GENERAL

This product and related documentation must be reviewed for familiarization with safety markings and instructions before operation. This product has been designed and tested in accordance with international standards.

### SAFETY SYMBOLS



Instruction manual symbol: the product will be marked with this symbol when it is necessary for the user to refer to the instruction manual (refer to Table of Contents).



Indicates hazardous voltages.



Indicates earth (ground) terminal.

**WARNING**

The WARNING sign denotes a hazard. It calls attention to a procedure, practice, or the like, which, if not correctly performed or adhered to, could result in personal injury. Do not proceed beyond a WARNING sign until the indicated conditions are fully understood and met.



The CAUTION sign denotes a hazard. It calls attention to an operating procedure, practice, or the like, which, if not correctly performed or adhered to, could result in damage to or destruction of part or all of the product. Do not proceed beyond a CAUTION sign until the indicated conditions are fully understood and met.

### BEFORE APPLYING POWER

Verify that the product is configured to match the available main power source per the input power configuration instructions provided in this manual.

If this product is to be energized via an auto-transformer make sure the common terminal is connected to the neutral (grounded side of the mains supply).

### SERVICING

**WARNING**

*Any servicing, adjustment, maintenance, or repair of this product must be performed only by qualified personnel.*

*Adjustments described in this manual may be performed with power supplied to the product while protective covers are removed. Energy available at many points may, if contacted, result in personal injury.*

*Capacitors inside this product may still be charged even when disconnected from their power source.*

*To avoid a fire hazard, only fuses with the required current rating and of the specified type (normal blow, time delay, etc.) are to be used for replacement.*

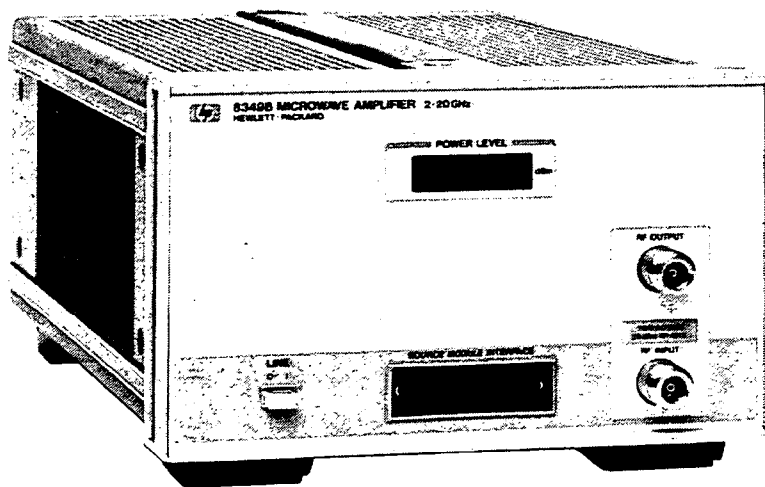

**HP 8349B  
MICROWAVE AMPLIFIER**

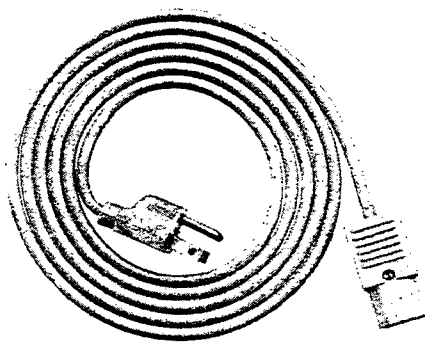

*Figure 1-1. HP 8349B Microwave Amplifier with Accessory Power Cable*

# Section 1. General Information

---

## INTRODUCTION

This manual contains operating and service information for the HP 8349B Microwave Amplifier. The differences between a standard instrument and options are discussed later in this section.

## MANUAL ORGANIZATION

This manual is divided into eight sections as follows:

**Section 1, General Information.** Contains the instrument description and specifications, supplemental characteristics, explains accessories and options, and lists recommended test equipment.

**Section 2, Installation.** Contains information concerning the initial mechanical inspection, preparation for use, operating environment, and packaging and shipping.

**Section 3, Operation.** Contains instructions for operating the instrument.

**Section 4, Performance Tests.** Contains the tests to verify that the electrical performance of the instrument meets the specifications.

**Section 5, Adjustments.** Contains the adjustment procedures.

**Section 6, Replaceable Parts.** Contains parts lists and ordering information.

**Section 7, Manual History.** Contains backdating information to make this manual compatible with earlier equipment configurations.

**Section 8, Service.** Contains schematic and block diagrams, component locations illustrations, circuit illustrations and descriptions, and troubleshooting information to aid in repair of the instrument.

## INSTRUMENTS COVERED BY MANUAL

### Serial Numbers

Attached to the back of your instrument is a serial number label (Figure 1-3). The serial number is in two parts. The first four digits and the letter are the serial number prefix; the last five digits are the suffix. The prefix changes only when a change is made to the instrument. The suffix, however, is assigned sequentially and is different for each instrument.

The contents of this manual apply to instruments with the serial number prefix(es) listed under SERIAL NUMBERS on the title page. A manual history section makes the manual compatible with instruments having serial number prefixes earlier than listed on the title page.

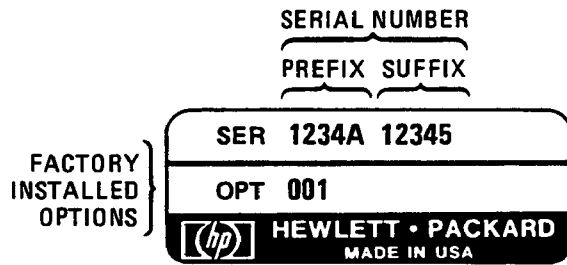

Figure 1-2. Typical Serial Number Plate

## INSTRUMENT DESCRIPTION

The HP 8349B is a general purpose, fully self-contained, class A microwave amplifier that delivers a minimum of 80 mW (+ 19 dBm) of leveled power from 2 to 18.6 GHz, and 40 mW (+ 16 dBm) from 18.6 to 20 GHz. It may be used with a fixed or swept frequency source. Leveled flatness is + .25 dB, and small signal (-5 dBm) gain is 15 dB. Equipped with a source module interface, the HP 8349B is capable of driving the HP 83550-series millimeter-wave source modules.

## SPECIFICATIONS

Specifications are listed in Table 1-1. These are the performance standards against which the amplifier is tested (performance tests are provided in Section 4). Table 1-2 lists typical or nominal values. They are additional information only and are not the warranted performance standards (specifications).

### Manufacturer's Declaration

#### NOTE

This is to certify that this product meets the radio frequency interference requirements of Directive FTZ 1046/1984. The German Bundespost has been notified that this equipment was put into circulation and has been granted the right to check the product type for compliance with these requirements.

Note: If test and measurement equipment is operated with unshielded cables and/or used for measurements on open set-ups, the user must insure that under these operating conditions, the radio frequency interference limits are met at the border of his premises.

Model HP 8349B

#### NOTE

Hiermit wird bescheinigt, dass dieses Gerät/System in Übereinstimmung mit den Bestimmungen von Postverfügung 1046/84 funkentstört ist.

Der Deutschen Bundespost wurde das Inverkehrbringen dieses Gerätes/Systems angezeigt und die Berechtigung zur Überprüfung der Serie auf Einhaltung der Bestimmungen eingeräumt.

Zusatzinformation für Mess- und Testgeräte:

Werden Mess- und Testgeräte mit ungeschirmten Kabeln und/oder in offenen Messaufbauten verwendet, so ist vom Betreiber sicherzustellen, dass die Funk-Entstörbestimmungen unter Betriebsbedingungen an seiner Grundstücksgrenze eingehalten werden.



Table I-1. Specifications

The following specifications describe the instruments warranted performance over the temperature range 0 to 55°C (except where noted).

**FREQUENCY RANGE:** 2.0 to 20.0 GHz

**INPUT AND OUTPUT (25°C ± 5°C):**

**Minimum Output Power (at +5 dBm input)**

Frequency Range (GHz)	Output	
	Leveled	Unleveled
2.0 to 18.6	19 dBm (80 mW)	20 dBm (100 mW)
18.6 to 20.0	17 dBm (40mW)	18 dBm (50 mW)

**Minimum Small Signal Gain (at -5 dBm input)**

Frequency Range (GHz)	Gain
2.0 to 18.6	15 dB
18.6 to 20.0	12 dB

**VSWR (2 to 18 GHz):** Input: ≤2.8:1  
Output: ≤2.5:1 (Leveled)

**Output Power Temperature Stability (Unleveled):** -0.1 dB/°C

**Power Flatness (Leveled):** ±1.25 dB

**Gain Temperature Stability:** -0.1 dB/°C

**Maximum Continuous Input:** +26 dBm (RF), ±10 VDC

**SPECTRAL PURITY (25°C ± 5°C):**

**Harmonics (dB below the fundamental at maximum specified output power):** 2.0 to 11.0 GHz < -20 dBc  
**Non-Harmonic Spurious (dB below the fundamental at maximum specified output power):** < -55 dBc

**GENERAL:**

**LED Display Accuracy (25°C + 5°C), CW Frequencies and Full Band Sweep Times > 4 sec:**

Calibrated Range: 0 dBm to +20 dBm  
Calibrated Accuracy: ±1.5 dB

**RF Input/Output Connectors:** Type-N Female RF

**RF Input/Output Connectors:** Type-N Female

**Power Requirements:** 50 to 400 Hz, 100, 120, 200, or 240 Volts (± 10%); 85 VA maximum

**Weight:** Net 7 kg (15 lb). Shipping 14 kg (31 lb).

**Dimensions:**

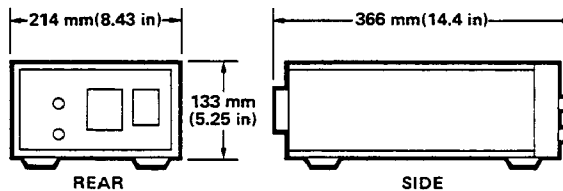
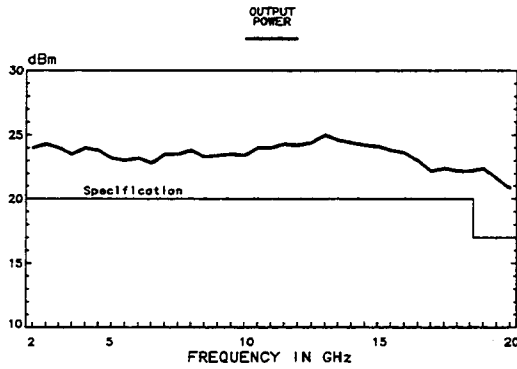

Table 1-2. Supplemental Characteristics

Supplemental Characteristics are intended to provide information useful in applying the instrument by giving typical but not warranted performance parameters.

**INPUT AND OUTPUT:**



Maximum Unleveled Output Power

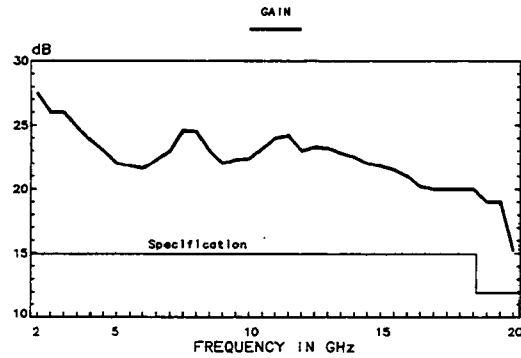

Small Signal Gain (at -5 dBm input)

**VSWR:**

Frequency Range (GHz)	Output Unleveled
2.0 to 5.0	≤ 4.8:1
5.0 to 11.0	≤ 3.8
11.0 to 18.0	≤ 3.2:1

1 dB Compression Point: +21 dBm

Noise Figure: <13 dB

Impedance (input and output): 50 ohm

Output Power Detector Voltage (used for leveled mode):

Low Level Sensitivity: >-1.0 mV/mW

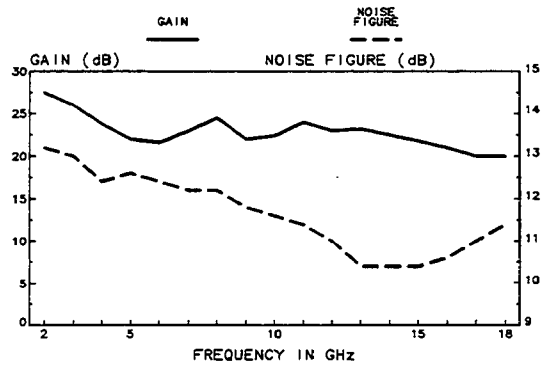

Gain and Noise Figure

**SPECTRAL PURITY:**

Harmonics (dB below the fundamental at maximum specified output power):

11.0 to 20.0 GHz: <-30 dBc

Third Order Intercept: +33 dBm

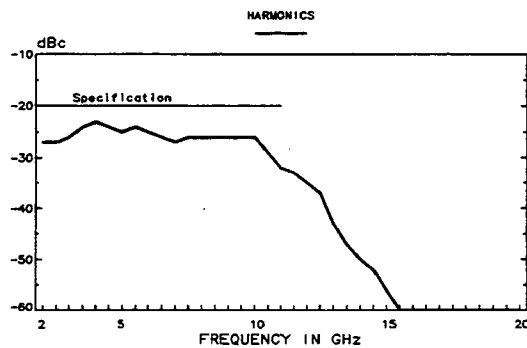

Harmonic Content

**PULSE TRANSMISSION CAPABILITY:**

Rise/Fall Time: <10 ns

Delay Time (input to output): <8 ns

**GENERAL SPECIFICATIONS:**

Reverse Isolation: >50 dB

## EQUIPMENT AVAILABLE

The HP 8349B Microwave Amplifier is supplied with a power cable as shown in Figure 1-1. Additionally, as shown in Figure 1-2, the following service accessories are available:

- 1 Extender Bracket (both heat sinks), HP Part No. 08349-00005
- 1 Bias Extender Board, HP Part No. 08349-60058
- 1 Regulator/Signal Conditioning Extender Board, HP Part No. 08349-60059

## OPTIONS

**Option 001, Rear Panel RF Input/Output.** Places the input and output connectors on the rear panel of the HP 8349B Microwave Amplifier. Refer to Figure 1-4a.

**Option 002, Rear Panel RF Input and Front Panel RF Output.** Places the input connector on the rear panel and the output connector on the front panel. Refer to Figure 1-4b.

**Option 910, Additional Operation and Service Manual.** Instruments ordered with Option 910 are supplied with two Operation and Service Manuals. Additional manuals are also available through your nearest Hewlett-Packard Sales/Service office by ordering the HP part number listed on the title page.

## RACK MOUNTING KITS AND CABINET ACCESSORIES

Rack mounting kits are available for mounting the instrument in a rack 482.6 mm (19 inch) wide. Other accessories such as filler panels, joining kits, shelves, and bail handles are also available. Refer to your current Hewlett-Packard Electronics Instrument Catalog for details. All of these kits and accessories are available through your nearest Hewlett-Packard Sales/Service office.

## RECOMMENDED TEST EQUIPMENT AND ACCESSORIES

Test equipment and accessories recommended for servicing and testing the HP 8349B Microwave Amplifier are listed in Table 1-3. If substitute equipment is used, it must meet the minimum specifications shown in the table. You can also use this list as a reference for the equipment necessary to make reflection and transmission measurements.

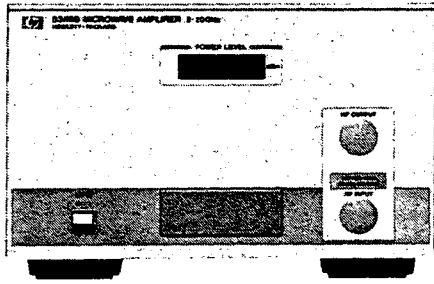

**FRONT PANEL**

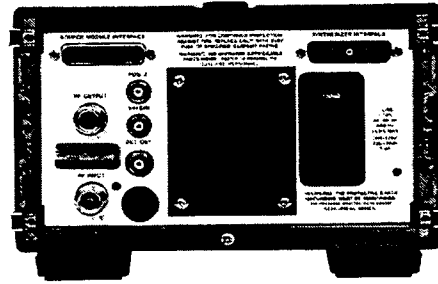

**REAR PANEL**

*Figure 1-3a. HP 8349B Option 001*



**FRONT PANEL**

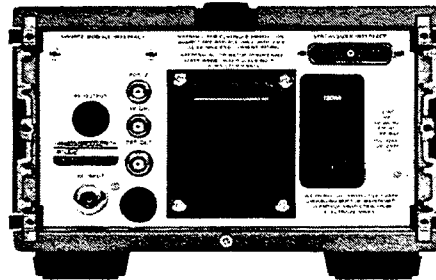

**REAR PANEL**

*Figure 1-3b. HP 8349B Option 002*

Table 1-3. Recommended Test Equipment

Instrument	Critical Specifications	Recommended Model	Use <sup>1</sup>
Sweep Oscillator	Compatible with plug-in	HP 8350B	P, A, T
RF Plug-in <sup>2</sup>	2 to 20 GHz coverage, $\geq +7$ dBm leveled output power, external leveling capability	HP 83590A	P, A, T
RF plug-in <sup>2</sup>	Non-Harmonic Spurious: $\leq -55$ dBc	HP 83592C	P
Scalar network analyzer	Capable of transmission/reflection measurement, waveform storage and normalization	HP 8757A	P, T
Spectrum analyzer	2 to 20 GHz Coverage, 2 channel display, waveform storage and normalization capability	HP 8566B	P, T
Power meter	-10 to +20 dBm	HP 436A	P, A, T
Power sensor	2 to 20 GHz coverage, calibrated range -10 to +20 dBm, maximum input +24 dBm	HP 8485A	P, A, T
Digital voltmeter	Range: -50V to +50V Accuracy: $\pm 0.01\%$ Input Impedance: $\geq 10$ M ohms	HP 3456A	A, T
Dual directional coaxial coupler	2 to 18 GHz coverage, 30 dB directivity, type-N male test port	HP 1169D Option 002	P
Directional coaxial coupler	2 to 20 GHz Coverage	HP P/N 0955-0125	P
Detector	2 to 20 GHz coverage, +10 dBm max input, compatible with plug-in	HP 8473C	P
Detectors (2)	2 to 18 GHz coverage, compatible with network analyzer Range: -20 to +10 dBm	HP 11664A	P
Detector	2 to 20 GHz coverage, compatible with network analyzer Range: -20 to +20 dBm	HP 11664E	P
Attenuator	10 dB, 2 to 20 GHz coverage	HP 8493C Option 010	P
Airlines (2)	20 cm, SWR $\leq 1.08$ at 18 GHz	HP 11567A	P
50 Ohm load	Type-N male, SWR $\leq 1.30$ at 18 GHz	HP 909A Option 012	P
50 Ohm load	APC-7 <sup>3</sup> SWR $\leq 1.25$ at 18 GHz	HP 909A	P
Extender boards (2)		HP P/N 08349-60058 HP P/N 08349-60059	A, T
Brackets (2)		HP P/N 08349-00005	A, T
Open	Type-N female	HP P/N 85032-20001	P, A, T
Short	Type-N Female	HP 11511A	P, A, T
Short	APC-7	HP 11565A	P, A, T
Adapter (4)	Type-N male to precision 3.5 mm female	HP P/N 1250-1744	P, A, T
Adapter	Type-N male to precision 3.5 mm male	HP P/N 1250-1743	P, A, T
Adapter	Type-N male to APC-7	HP 11525A	P, A, T
Adapter	APC-7 to precision 3.5 mm female	HP P/N 1250-1747	P, A, T
Cable	BNC connectors 61 cm (24 in)	HP 11170B	P, A, T
Cable (3)	BNC connectors 122 cm (48 in)	HP 11170C	P, A, T
Cable (2)	SMA connectors 61 cm (24 in)	HP P/N 8120-3124	P, A, T
Cable	Type-N Male connectors, 61 cm (24 in)	HP 11500B	P, A, T

1. P = Performance Test; A = Adjustment; T = Troubleshooting
2. Must have 0.5V/GHz input connector modification.
3. APC-7 is a registered trademark of Bunker Ramo Corporation.



## Section 2. Installation

---

### INTRODUCTION

This section contains information on initial inspection, preparation for use, storage and packaging.

### INITIAL INSPECTION

If the shipping container or material is damaged, it should be kept until the contents are checked for completeness, and the instrument has been checked mechanically and electrically.

First, check for completeness. Figure 1-1 shows all of the items you should receive per amplifier.

Second, check connectors, cable, and body for mechanical damage.

Third, test the amplifier electrically by either making measurements or testing to the specifications. Refer to "Operation" or "Performance Tests" in this manual.

Notify your nearest Hewlett-Packard office if any of the following conditions exist:

- Shipping contents are incomplete.
- There is mechanical damage or defect.
- The instrument does not pass electrical tests.

Also, notify the carrier if the shipping container is damaged or the cushioning material shows signs of stress. Keep all shipping materials for the carrier's inspection. Hewlett-Packard will arrange for repair or replacement without waiting for a claim settlement.

### SAFETY CONSIDERATIONS

Before operating this instrument, familiarize yourself with the safety markings on the instrument and safety instructions in this manual. This instrument has been manufactured and tested according to international safety standards. However, to ensure safe operation of the instrument and personnel, the cautions and warnings in this manual must be followed. Refer to the summary of safety notations at the front of this manual. Refer also to individual sections for detailed safety instructions.

### PREPARATION FOR USE

#### Power Requirements

The HP 8349B requires a power source of 100, 120, 220, or 240 volts,  $\pm 10\%$ ; 50 to 400 Hz. Power consumption is 85 VA maximum.

## WARNING

**BEFORE THIS INSTRUMENT IS SWITCHED ON**, its protective earth terminals must be connected to the protective conductor of the (mains) power cable (cord). The power cable plug should only be inserted in a socket outlet provided with a protective earth contact. **DO NOT** negate the earthing protection by using an extension cable, power cable, or autotransformer without a protective ground conductor. Failure to ground the instrument properly may result in serious personal injury.

## CAUTION

**BEFORE SWITCHING ON THIS INSTRUMENT**, be sure it is adapted to the voltage of the AC power source. On the rear panel check that power line module indicates the voltage of the AC power source. Failure to set the AC power input of the instrument for the correct voltage level could cause damage to the instrument when it switched on.

### Line Voltage and Fuse Selection

Adapt the instrument to the AC line voltage level as follows:

1. Determine the AC line voltage.
2. Refer to Figure 2-1. At the instrument's rear panel power line module, pry open the module door to reveal a rotating cam. *Do not rotate the cam in the module!* Rotate the cam to the desired voltage so that the voltage is visible through the window when the door is closed. Note that the available line voltage must be within  $\pm 10\%$  of the line voltage selected on the rotating cam. If it is not, you must use an autotransformer between the AC source and the HP 8349B.
3. The rated fuse for all AC line voltage is 1 ampere.
4. Close the module cover door.

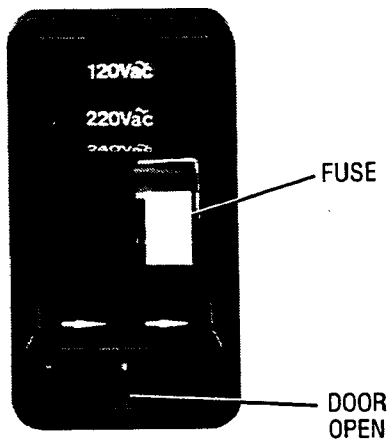

### Replacement of Fuse

1. Pry open POWER MODULE cover door.
2. Pull out grey carrier.
3. Insert fuse of proper rating.
4. Replace carrier in POWER MODULE

### Selection of Operating Voltage

1. Pry open POWER MODULE cover door.
2. **Remove the cam from the module.**
3. Rotate cam to desired voltage so that the voltage is visible through window when door is closed.
4. Insert cam back into the module.
5. Close cover door.

Figure 2-1. Line Voltage Selection with Power Module Rotating Cam



## Replacement of Fuse

1. Pry open POWER MODULE cover door.
2. Pull out grey carrier.
3. Insert fuse of proper rating.
4. Replace carrier in POWER MODULE

## Power Cable

In accordance with international safety standards, this instrument is equipped with a three wire power cable. When connected to an appropriate power line outlet, this cable grounds the instrument cabinet. Table 2-1 shows the various plug types and their respective HP part number.

### WARNING

**Instrument grounding may be lost if any power cable other than the 3-prong type is used to couple the AC line voltage to the instrument.**

## Operating Environment

This instrument should be operated within the following limits:

Temperature: 0 to 55°C  
Altitude: <4572 metres (15,000 feet)  
Humidity: 5% to 80% relative at +25°C to +40°C

## STORAGE AND SHIPMENT

### Environment

The instrument may be stored or shipped in environments within the following limits:

Temperature: -40°C to +75°C  
Altitude: <7620 metres (25,000 feet)  
Humidity: 5% to 95% relative at 0°C to +40°C

### Packaging

Containers and materials identical to those used in factory packaging are available through Hewlett-Packard offices. Figure 2-2 illustrates the proper method of packaging the instrument for shipment.

If you package the instrument with commercially available materials, follow these instructions:

1. Wrap the instrument in heavy paper.
2. Use a strong shipping container. A double-wall carton made of 350-pound test material is adequate.
3. Use enough shock-absorbing material (3 to 4 inch layer) around all sides of the instrument to provide a firm cushion and prevent movement. Protect the front panel with cardboard.
4. Mark the shipping container FRAGILE.

## Returning for Service

If you are shipping the instrument to an HP office or service center please include the following:

1. Your company name and address.
2. Technical contact person with complete phone number.
3. Complete model and serial number of the instrument.
4. Type of service required (calibration vs. repair).
5. Any other information that may expedite service.

For your convenience, a page of preprinted fill-in tags are provided at the end of this section. When making inquiries, please refer to the instrument by model and full serial number.

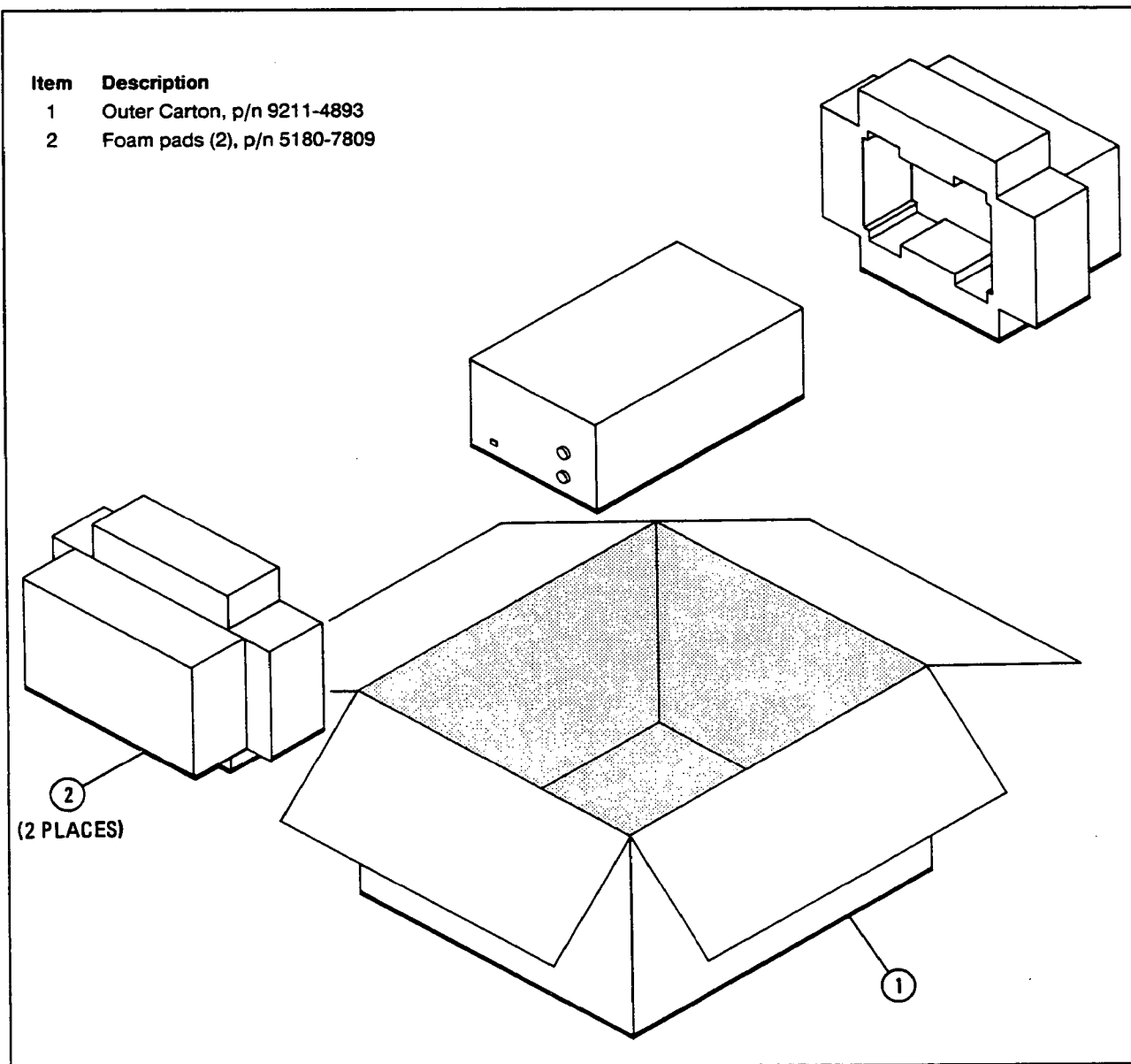

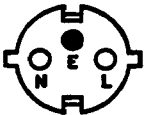

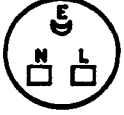
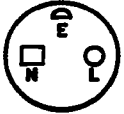



Figure 2-2. HP 8349B Factory Packaging

Table 2-1. AC Power Cables and Plugs

PLUG TYPE <sup>1</sup>	CABLE HP PART NUMBER <sup>2</sup>	PLUG DESCRIPTION <sup>2</sup>	CABLE LENGTH (inches)	CABLE COLOR	FOR USE IN COUNTRY
<p>250V</p> 	8120-1351 8120-1703	Straight BS1363A 90°	90 90	Mint Gray Mint Gray	United Kingdom, Cyprus, Nigeria, Zimbabwe, Singapore
<p>250V</p> 	8120-1369 8120-0696	Straight ZNSS198/ASC112 90°	79 87	Gray Gray	Australia, New Zealand
<p>250V</p> 	8120-1689 8120-1692	Straight CEE7-VII 90°	79 79	Mint Gray Mint Gray	East and West Europe, Saudi Arabia, Egypt, Republic of So. Africa, India (unpolarized in many nations)
<p>125V</p> 	8120-1348 8120-1398 8120-1754 8120-1378 8120-1521 8120-1676	Straight NEMA5-15P 90° Straight NEMA5-15P Straight NEMA5-15P 90° Straight NEMA5-15P 36	80 80 36 80 80 36	Black Black Black Jade Gray Jade Gray Jade Gray	United States, Canada, Japan, (100V or 200V), Mexico, Philippines, Taiwan
<p>250V</p> 	8120-2104	Straight SEV1011.1959 24507, Type 12	79	Gray	Switzerland
<p>250V</p> 	8120-0698	Straight NEMA6-15P			United States, Canada
<p>220V</p> 	8120-1957 8120-2956	Straight DHCK 107 90°	79 79	Gray Gray	Denmark
<p>250V</p> 	8120-1860	Straight CEE22-VI (System Cabinet Use)			

1. E = Earth Ground; L = Line; N = Neutral.  
2. Part number for plug is industry identifier for plug only. Number shown for cable is HP Part Number for complete cable including plug.



## Section 3. Operation

---



**SUSCEPTIBLE TO DAMAGE FROM STATIC DISCHARGE.** Repeated electrostatic discharge (ESD) as low as 250 volts can destroy microwave devices. If discharge is noticed, it indicates a voltage of 20,000 volts or more. Material conducive to static build-up include carpet, nylon, dry air, paper, adhesive tape, styrofoam and vinyl. The best way to prevent ESD is for the operator to wear a grounding strap connected to a conductive bench mat that provides a path to ground of between 1 and 2.5 Megohms. The operator can ground him/herself by touching any grounded instrument before touching any HP 8349B RF connectors. Never touch the center contacts.

### INTRODUCTION

This section provides information that will enable you to use the HP 8349B in a variety of applications. Included are hookup diagrams that illustrate the HP 8349B used as both an amplifier and a dedicated source driver for the HP 83550-series millimeter-wave source modules. At the back of this section are the amplifier's front and rear panel features, including controls and connectors.

### OPERATOR'S CHECK

Following is an operator's check of the HP 8349B, which allows you to make a quick check of the amplifier prior to use. The procedures cover the entire measurement system, and incorrect indications may be caused by any portion of the system. If the amplifier and/or its source module interface is suspected, use the performance tests in Section 4 to determine if they are working correctly. If not, refer to Section 8, Service, to isolate the problem.

### Rack Mounted Operation

The physical configuration of the HP 8349B makes it compatible with EIA and IEC racking standards. The half rack configuration of the HP 8349B allows for mounting in a rack by itself, or closely alongside another instrument. Mounted either way, the effective convection cooling system of the HP 8349B enables it to operate at less than 10°C above the ambient temperature of the rack environment.

### APPLICATIONS

The HP 8349B Microwave Amplifier may be used in a wide range of applications. The following descriptions and illustrations (Figures 3-2 through 3-5) explain four possible applications.

The HP 8349B is a portable extension of the source. The spectral purity of the amplifier output will depend primarily on the power levels of the fundamental and harmonic input signals from the source. However, there will be some low power harmonically related spurious signals generated by the HP 8349B during high power inputs. These spurious signals are specified to be below the power level of the fundamental input signal by at least 20 dB (see Table 1-1). As with all amplifiers and sources, the spectral purity of the output may be improved by using low pass, high pass, bandpass, or tracking filters.

## HP 8349B OPERATOR'S CHECK

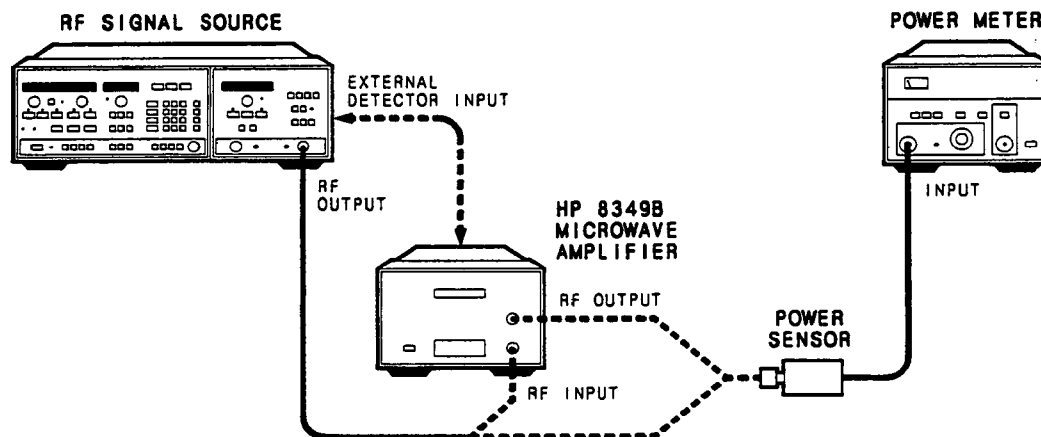

### EQUIPMENT

RF Signal Source .....	See Table 1-3
Amplifier .....	HP 8349B
Power Meter .....	See Table 1-3

### PROCEDURE

1. Set signal source to desired frequency (or frequency range).
2. Connect power sensor to source output. Set source output power to approximately +5 dBm.
3. Connect source output to amplifier input. Connect power sensor to amplifier output. Power meter should read approximately +19 dBm from 2 to 18.6 GHz and +17 dBm from 18.6 GHz to 20 GHz. In the unlevelled mode, the power meter should read approximately +20 dBm from 2 to 18.6 GHz and +18 dBm from 18.6 to 20 GHz.

**NOTE:** This is only a rough check. For a more complete check, see Section 4, Performance Tests.

### POWER AMPLIFIER

Figure 3-2 shows a general equipment configuration with the HP 8349B used as a power amplifier. The power level at the output of the amplifier is adjusted with the signal source power control and is read on the HP 8349B power display.

As a power amplifier, the HP 8349B Microwave Amplifier may be used in an unlevelled or an externally levelled mode when combined with a microwave source. When used in an unlevelled mode, the power display may not respond to rapid power variations such as a fast sweep rate. Sweep rate has no effect on the power output of the HP 8349B but should be at least 22 ms per GHz to maintain instantaneous power display accuracy.

To use the HP 8349B in the externally leveled mode, connect the detector output of the HP 8349B to the external detector input of the source (up to +19 dBm of leveled power from 2.0 to 18.6 GHz or +17 dBm from 18.6 to 20.0 GHz is available). The external level in circuitry of the source must be compatible with the amplifier's built-in detector. The HP 8349B's detector has a sensitivity of greater than  $-1.0$  mV/mW and is able to drive impedances as low as 100 ohms. Leveled output power is indicated by the state of the "UNLEVELED" indicator on the source. To achieve maximum leveled power, increase source output power until the "UNLEVELED" indicator on the source lights, then back off until the light goes out. The HP 8349B is now delivering maximum leveled power.

Utilizing the HP 8349B as a power amplifier, you can do the following: TWT amplifier testing, antenna pattern analysis, long RF cable testing, RFI measurements, and mixer driving. Sources used in high power pulsed microwave applications can also benefit from the minimal pulse rise/fall time (typically less than 10 ns) and input to output delay time (typically less than 8 ns).

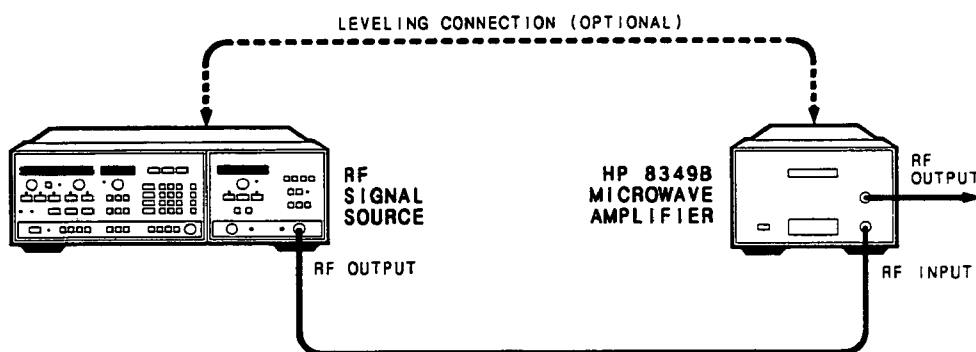

Figure 3-2. HP 8349B Used as a Power Amplifier

## WIDEBAND PREAMPLIFIER



**With a +5 dBm input, output power from the amplifier may be as high as +26 dBm. Therefore, it is very important to ensure adequate protection of the following device or instrument input circuitry.**

The HP 8349B Microwave Amplifier may be used as a wideband preamplifier for spectrum analyzers, microwave frequency counters, and scalar network analyzers. Spectrum analyzers with 30 dB noise figures may typically realize 15 to 20 dB signal to noise ratio improvements (Figure 3-3).

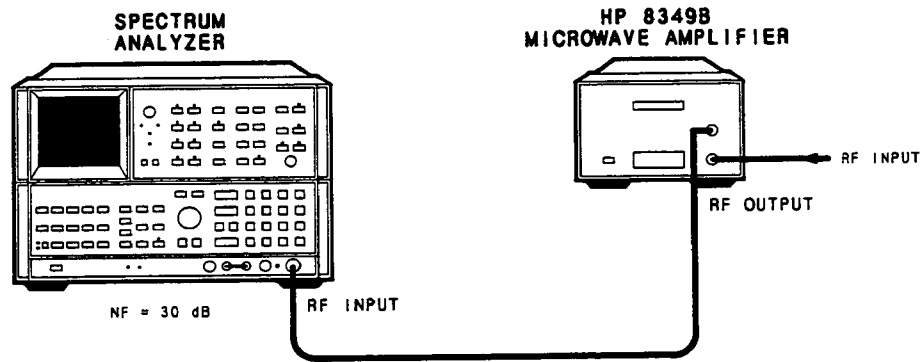

OVERALL SYSTEM NOISE FIGURE: 17dB  
 USING  $F = F_1 + (F_2 - 1/G_1)$   
 Where  $F_1$  = Noise Factor of amplifier  
 $F_2$  = Noise Factor of spectrum analyzer  
 $G_1$  = Gain of amplifier

Figure 3-3. HP 8349B Used as Preamplifier for a Spectrum Analyzer

Microwave frequency counters with  $-25$  dBm sensitivity may typically realize a 10 to 20 dB sensitivity improvement (Figure 3-4).

Scalar network analyzers may go beyond the typical 60 dB dynamic range and achieve greater than 80 dB dynamic range when using the HP 8349B in an extended dynamic range configuration (Figure 3-5).

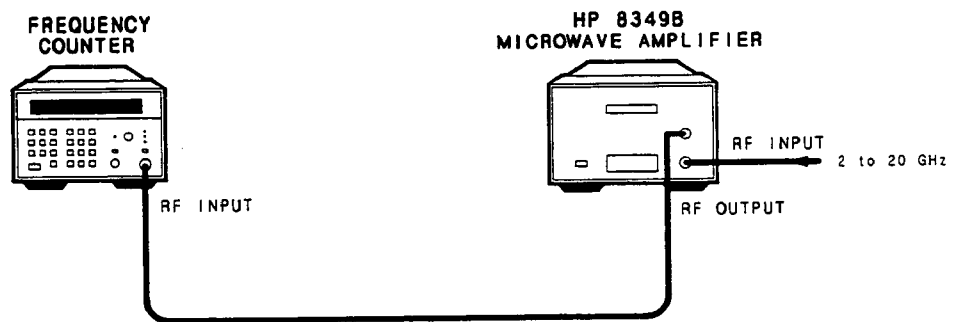

Figure 3-4. HP 8349B used as a preamplifier for a frequency counter



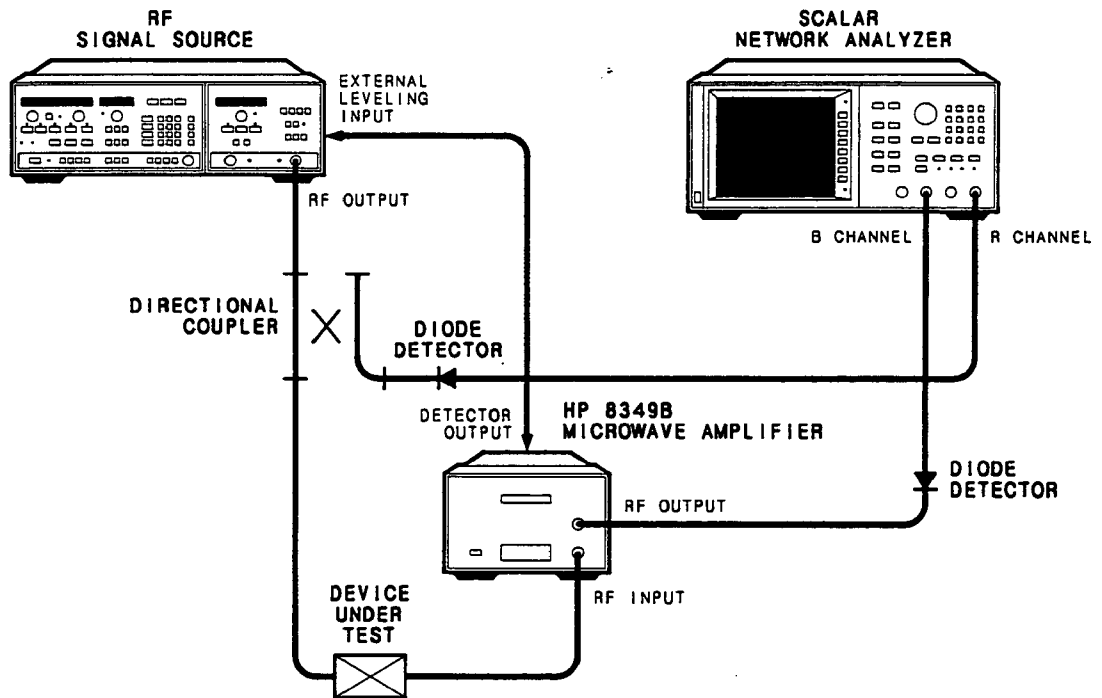

Figure 3-5. HP 8349B uses as a dynamic range extender with a scalar network analyzer

### DEDICATED HP MILLIMETER-WAVE SOURCE MODULE DRIVER

The HP 8349B may also be used to drive the HP 83550-series millimeter-wave source modules. The HP 8349B amplifies an 11 to 20 GHz microwave signal to  $> +17$  dBm. A built-in source module interface provides DC bias and control signals required by the source modules.

For applications that require a millimeter-wave sweep oscillator, the HP 8349B and 83550-series source module combination can be used with the HP 8350B and an 11 to 20 GHz RF plug-in (Figure 3-6).

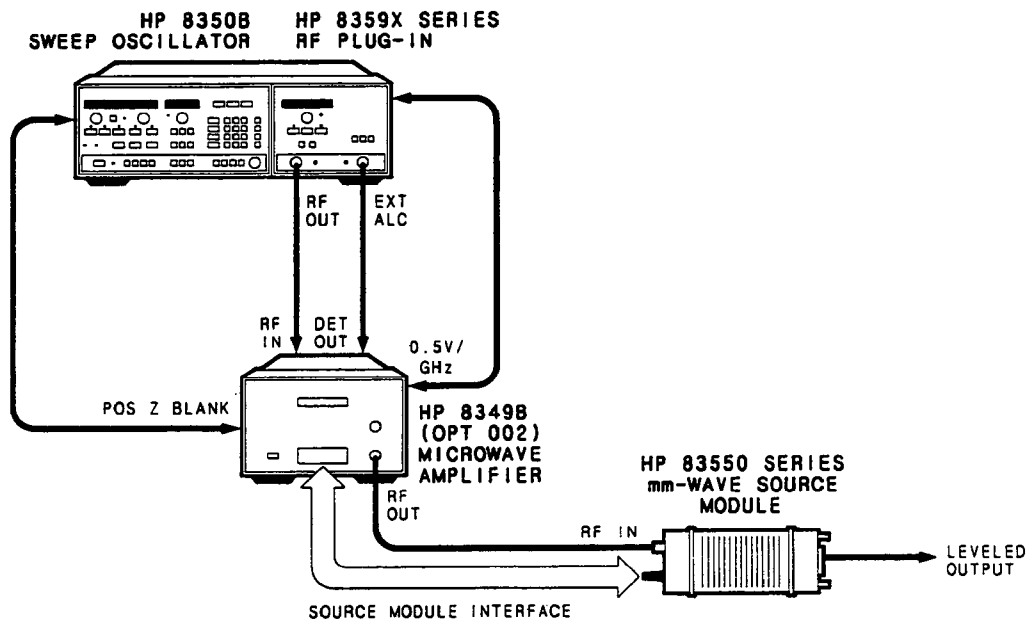

Figure 3-6. HP 8350B/8359X/8349B/83550-Series Source Configuration

For applications that require a millimeter-wave synthesizer, the HP 8349B and HP 8355-series source module combination can be used with either the HP 8340A/41A synthesized sweep oscillators (Figure 3-7), or the HP 8672A/S and HP 8673B/C/D synthesized signal generators (Figure 3-8).

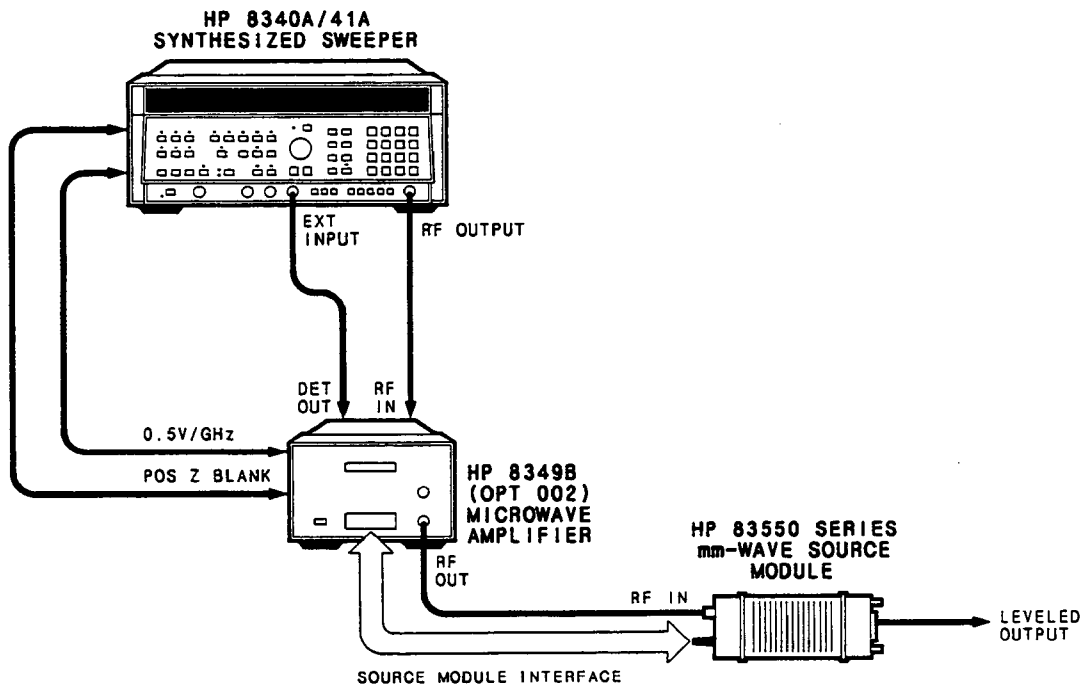

Figure 3-7. HP 8340A/41A/8349B/83550-Series Source Configuration

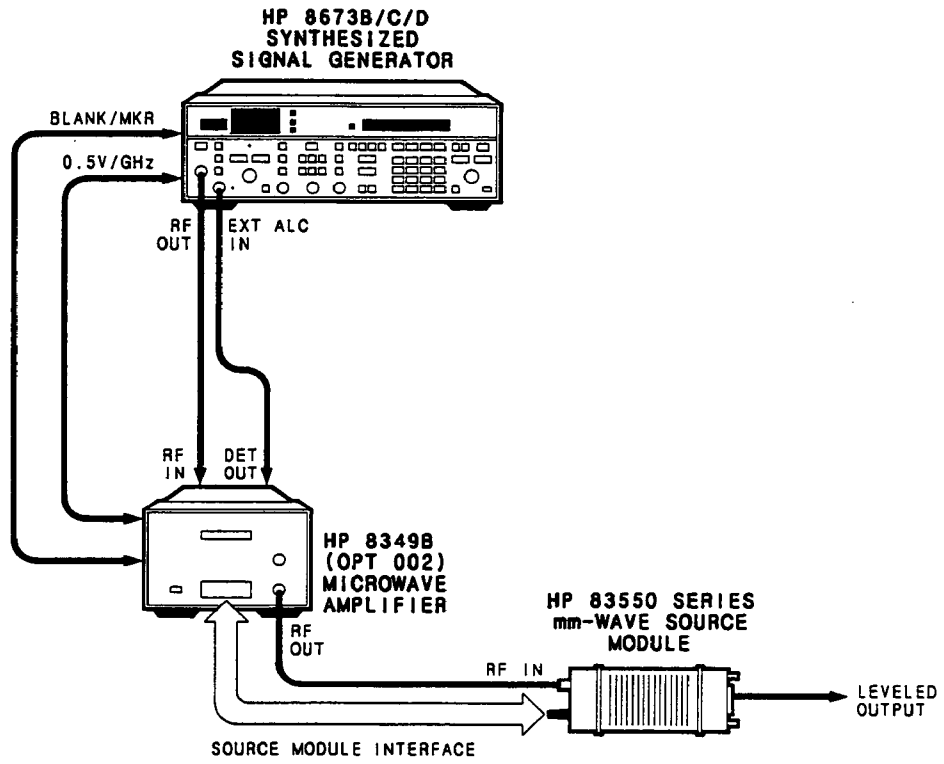
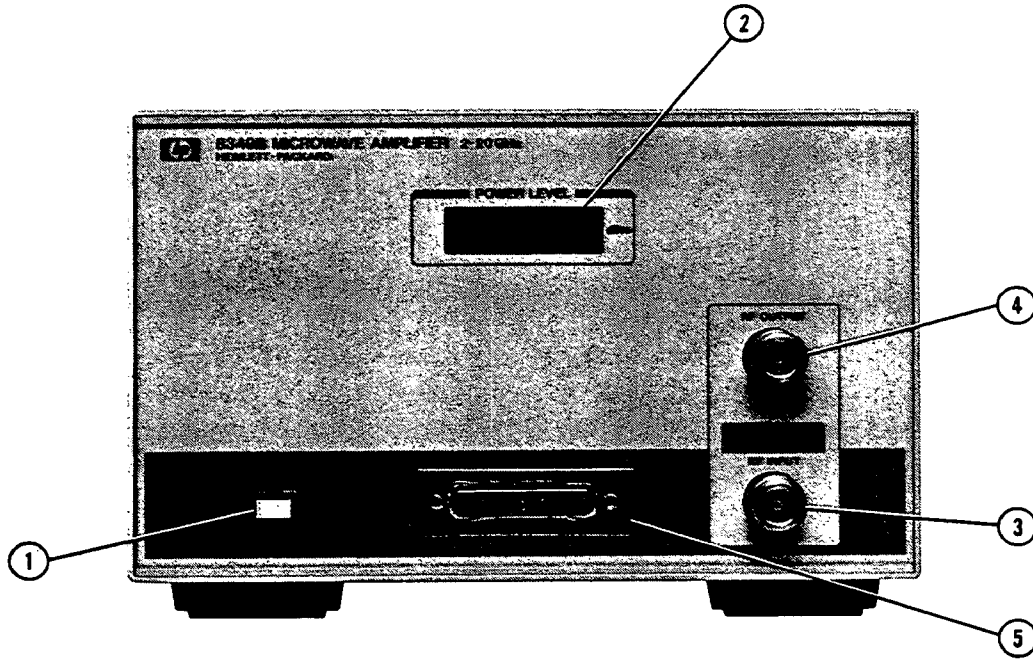
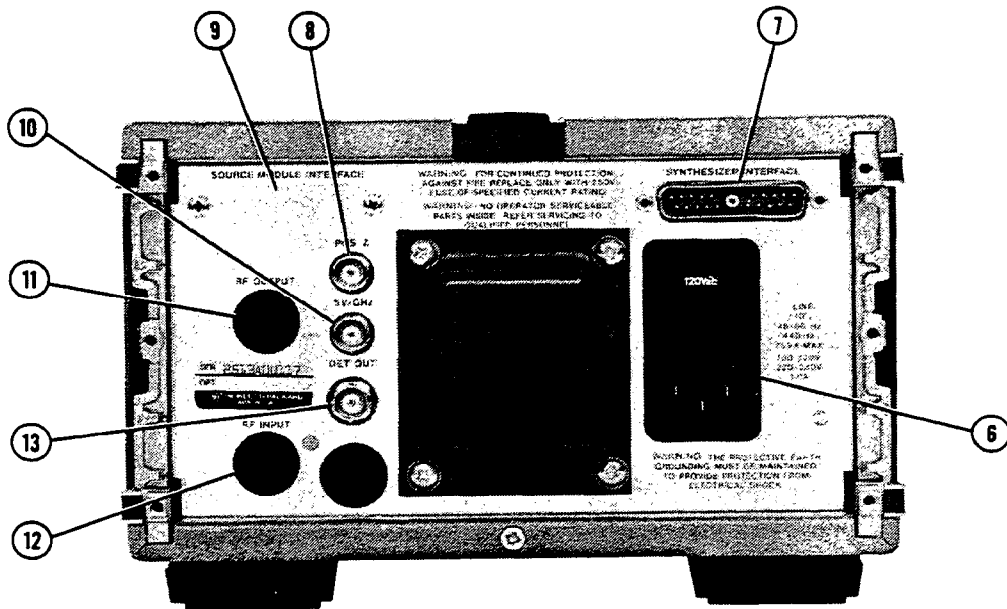

Figure 3-8. HP 8673B/C/D/8349B/83550-Series Source Configuration

# PANEL FEATURES



Front Panel



Rear Panel

1. **AC MAINS ON-OFF.** Turns the instrument's ac power (ac mains) on or off.
2. **POWER LEVEL.** An internal power indicator displays output power to tenths of dBm, from 0 to +20 dBm.
3. **RF INPUT (standard).** A type-N (female) connector supplies RF input power to the amplifier.

**WARNING**

**To avoid damaging the amplifier's circuitry, signals applied to the INPUT connector must not exceed +27 dBm RF, or  $\pm 10V$ .**

4. **RF OUTPUT (standard and Option 002).** A type-N (female) connector supplies amplified RF output power.
5. **SOURCE MODULE INTERFACE.** 20-pin D connector, connects the HP 8349B and the HP 83550-series millimeter-wave source modules together via a cable. This provides the source modules with the necessary DC bias and control signals from the HP 8349B and microwave source for proper operation. The interface also enables the source modules to send leveling and other signals back to the HP 8349B.
6. **AC POWER MODULE.** Contains the three-wire ac power receptacle, line voltage (100, 120, 220, 240 volts) selector, line fuse, and line filter.
7. **SYNTHESIZER INTERFACE.** 20-pin D connector, connects the HP 8349B to a compatible source, enabling the source to pass information directly to and from the millimeter-wave source modules.
8. **POS Z BLANK.** Holds the amplifier's LED power display while the swept source passes switch points and retraces.
9. **SOURCE MODULE INTERFACE (Option 001).** 20-pin D connector, same as standard configuration, except located on rear panel.
10. **0.5V/GHz.** Accepts a voltage proportional to the frequency of the microwave source. This signal is used in the power flatness correction feature.
11. **RF OUTPUT (Option 001).** A type-N (female) connector supplies amplified RF output power, at the rear panel.
12. **RF INPUT (Option 001 and 002).** A type-N (female) connector supplies RF input power to the amplifier, at the rear panel.
13. **DETECTOR OUTPUT.** A BNC (female) connector outputs approximately  $-1.0mV/mW$  for use when leveling.



Should one of your HP instruments need repair, the HP service organization is ready to serve you. However, you can help us serve you more effectively. When sending an instrument to HP for repair, please fill out this card and attach it to the product. Increased repair efficiency and reduced turn-around time should result.

COMPANY \_\_\_\_\_

ADDRESS \_\_\_\_\_

TECHNICAL CONTACT PERSON \_\_\_\_\_

PHONE NO.      EXT. \_\_\_\_\_

MODEL NO.      SERIAL NO. \_\_\_\_\_

MODEL NO.      SERIAL NO. \_\_\_\_\_

P.O. NO.      DATE \_\_\_\_\_

Accessories returned with unit

NONE       CABLE(S)

POWER CABLE    ADAPTER(S)

OTHER \_\_\_\_\_ over



Should one of your HP instruments need repair, the HP service organization is ready to serve you. However, you can help us serve you more effectively. When sending an instrument to HP for repair, please fill out this card and attach it to the product. Increased repair efficiency and reduced turn-around time should result.

COMPANY \_\_\_\_\_

ADDRESS \_\_\_\_\_

TECHNICAL CONTACT PERSON \_\_\_\_\_

PHONE NO.      EXT. \_\_\_\_\_

MODEL NO.      SERIAL NO. \_\_\_\_\_

MODEL NO.      SERIAL NO. \_\_\_\_\_

P.O. NO.      DATE \_\_\_\_\_

Accessories returned with unit

NONE       CABLE(S)

POWER CABLE    ADAPTER(S)

OTHER \_\_\_\_\_ over



Should one of your HP instruments need repair, the HP service organization is ready to serve you. However, you can help us serve you more effectively. When sending an instrument to HP for repair, please fill out this card and attach it to the product. Increased repair efficiency and reduced turn-around time should result.

COMPANY \_\_\_\_\_

ADDRESS \_\_\_\_\_

TECHNICAL CONTACT PERSON \_\_\_\_\_

PHONE NO.      EXT. \_\_\_\_\_

MODEL NO.      SERIAL NO. \_\_\_\_\_

MODEL NO.      SERIAL NO. \_\_\_\_\_

P.O. NO.      DATE \_\_\_\_\_

Accessories returned with unit

NONE       CABLE(S)

POWER CABLE    ADAPTER(S)

OTHER \_\_\_\_\_ over



Should one of your HP instruments need repair, the HP service organization is ready to serve you. However, you can help us serve you more effectively. When sending an instrument to HP for repair, please fill out this card and attach it to the product. Increased repair efficiency and reduced turn-around time should result.

COMPANY \_\_\_\_\_

ADDRESS \_\_\_\_\_

TECHNICAL CONTACT PERSON \_\_\_\_\_

PHONE NO.      EXT. \_\_\_\_\_

MODEL NO.      SERIAL NO. \_\_\_\_\_

MODEL NO.      SERIAL NO. \_\_\_\_\_

P.O. NO.      DATE \_\_\_\_\_

Accessories returned with unit

NONE       CABLE(S)

POWER CABLE    ADAPTER(S)

OTHER \_\_\_\_\_ over



Should one of your HP instruments need repair, the HP service organization is ready to serve you. However, you can help us serve you more effectively. When sending an instrument to HP for repair, please fill out this card and attach it to the product. Increased repair efficiency and reduced turn-around time should result.

COMPANY \_\_\_\_\_

ADDRESS \_\_\_\_\_

TECHNICAL CONTACT PERSON \_\_\_\_\_

PHONE NO.      EXT. \_\_\_\_\_

MODEL NO.      SERIAL NO. \_\_\_\_\_

MODEL NO.      SERIAL NO. \_\_\_\_\_

P.O. NO.      DATE \_\_\_\_\_

Accessories returned with unit

NONE       CABLE(S)

POWER CABLE    ADAPTER(S)

OTHER \_\_\_\_\_ over



Should one of your HP instruments need repair, the HP service organization is ready to serve you. However, you can help us serve you more effectively. When sending an instrument to HP for repair, please fill out this card and attach it to the product. Increased repair efficiency and reduced turn-around time should result.

COMPANY \_\_\_\_\_

ADDRESS \_\_\_\_\_

TECHNICAL CONTACT PERSON \_\_\_\_\_

PHONE NO.      EXT. \_\_\_\_\_

MODEL NO.      SERIAL NO. \_\_\_\_\_

MODEL NO.      SERIAL NO. \_\_\_\_\_

P.O. NO.      DATE \_\_\_\_\_

Accessories returned with unit

NONE       CABLE(S)

POWER CABLE    ADAPTER(S)

OTHER \_\_\_\_\_ over

Service needed

- CALIBRATION ONLY
- REPAIR       REPAIR & CAL

OTHER \_\_\_\_\_

Observed symptoms/problems

FAILURE MODE IS:

- CONSTANT     INTERMITTENT

SENSITIVE TO:

- COLD     HEAT     VIBRATION

FAILURE SYMPTOMS/SPECIAL CONTROL SETTINGS \_\_\_\_\_

\_\_\_\_\_

\_\_\_\_\_

\_\_\_\_\_

\_\_\_\_\_

\_\_\_\_\_

\_\_\_\_\_

\_\_\_\_\_

If unit is part of system list model number(s) of other interconnected instruments. \_\_\_\_\_

Service needed

- CALIBRATION ONLY
- REPAIR       REPAIR & CAL

OTHER \_\_\_\_\_

Observed symptoms/problems

FAILURE MODE IS:

- CONSTANT     INTERMITTENT

SENSITIVE TO:

- COLD     HEAT     VIBRATION

FAILURE SYMPTOMS/SPECIAL CONTROL SETTINGS \_\_\_\_\_

\_\_\_\_\_

\_\_\_\_\_

\_\_\_\_\_

\_\_\_\_\_

\_\_\_\_\_

\_\_\_\_\_

\_\_\_\_\_

If unit is part of system list model number(s) of other interconnected instruments. \_\_\_\_\_

Service needed

- CALIBRATION ONLY
- REPAIR       REPAIR & CAL

OTHER \_\_\_\_\_

Observed symptoms/problems

FAILURE MODE IS:

- CONSTANT     INTERMITTENT

SENSITIVE TO:

- COLD     HEAT     VIBRATION

FAILURE SYMPTOMS/SPECIAL CONTROL SETTINGS \_\_\_\_\_

\_\_\_\_\_

\_\_\_\_\_

\_\_\_\_\_

\_\_\_\_\_

\_\_\_\_\_

\_\_\_\_\_

\_\_\_\_\_

If unit is part of system list model number(s) of other interconnected instruments. \_\_\_\_\_

Service needed

- CALIBRATION ONLY
- REPAIR       REPAIR & CAL

OTHER \_\_\_\_\_

Observed symptoms/problems

FAILURE MODE IS:

- CONSTANT     INTERMITTENT

SENSITIVE TO:

- COLD     HEAT     VIBRATION

FAILURE SYMPTOMS/SPECIAL CONTROL SETTINGS \_\_\_\_\_

\_\_\_\_\_

\_\_\_\_\_

\_\_\_\_\_

\_\_\_\_\_

\_\_\_\_\_

\_\_\_\_\_

\_\_\_\_\_

If unit is part of system list model number(s) of other interconnected instruments. \_\_\_\_\_

Service needed

- CALIBRATION ONLY
- REPAIR       REPAIR & CAL

OTHER \_\_\_\_\_

Observed symptoms/problems

FAILURE MODE IS:

- CONSTANT     INTERMITTENT

SENSITIVE TO:

- COLD     HEAT     VIBRATION

FAILURE SYMPTOMS/SPECIAL CONTROL SETTINGS \_\_\_\_\_

\_\_\_\_\_

\_\_\_\_\_

\_\_\_\_\_

\_\_\_\_\_

\_\_\_\_\_

\_\_\_\_\_

\_\_\_\_\_

If unit is part of system list model number(s) of other interconnected instruments. \_\_\_\_\_

Service needed

- CALIBRATION ONLY
- REPAIR       REPAIR & CAL

OTHER \_\_\_\_\_

Observed symptoms/problems

FAILURE MODE IS:

- CONSTANT     INTERMITTENT

SENSITIVE TO:

- COLD     HEAT     VIBRATION

FAILURE SYMPTOMS/SPECIAL CONTROL SETTINGS \_\_\_\_\_

\_\_\_\_\_

\_\_\_\_\_

\_\_\_\_\_

\_\_\_\_\_

\_\_\_\_\_

\_\_\_\_\_

\_\_\_\_\_

If unit is part of system list model number(s) of other interconnected instruments. \_\_\_\_\_





## Section 4. Performance Tests

---

### INTRODUCTION

The procedures in this section test the electrical performance of the HP 8349B using the specifications of Table 1-1 as the performance standards. All tests can be performed without access to the interior of the instrument. A simpler operational test is included in Section 3 under "Operator's Check."

The performance test procedures must be performed in the sequence given, since some procedures rely on satisfactory test results in foregoing steps. If a test measurement is slightly out of tolerance, go to Section 5 and perform the related adjustment procedures. If a function fails to operate, go to Section 8 for troubleshooting information.

### EQUIPMENT REQUIRED

Equipment required for the performance tests is listed in the "Recommended Test Equipment" table in Section 1. Any equipment that satisfies the critical specifications given in the table may be substituted for the recommended models. The recommended RF source (HP 83590A) must be equipped with a 0.5V/GHz input modification.

**NOTE:** Use only the connectors and cables that are specified in the following test setups to ensure accurate test results.

### OPERATION VERIFICATION

The Operation Verification consists of performing the Output Power, Gain, and Flatness performance tests. These tests provide reasonable assurance that the amplifier is functioning properly and should meet the needs of an incoming inspection (80% verification).

### TEST RECORD

Results of the performance tests may be recorded in the "Test Record" at the end of the procedures. The Test Record lists all of the tested specifications and their acceptable limits. Test results recorded at incoming inspection can be used for comparison in periodic maintenance and troubleshooting and after repairs or adjustments.

# Output Power, Gain, and Flatness

## SPECIFICATION

Minimum Output Power (25°C +5°C):

Frequency Range (GHz)	Input	Output	
		Leveled	Unleveled
2.0 to 18.6	5 dBm (3.2 mW)	19 dBm (80 mW)	20 dBm (100 mW)
18.6 to 20.0	5 dBm (3.2 mW)	16 dBm (40 mW)	18 dBm (50 mW)
2.0 to 20.0	5 dBm (3.2 mW)	16 dBm (40 mW)	18 dBm (50 mW)

Power Flatness (Leveled):  $\pm 1.25$  dB

Minimum Small Signal Gain:

Frequency Range (GHz)	Input	Gain
2.0 to 18.6	-5 dBm	15 dB
18.6 to 20.0	-5 dBm	12 dB

## DESCRIPTION

The Small Signal Gain specification is measured in two parts.

**Part 1.** Sweep oscillator set for a 2.0 to 18.6 GHz sweep.

**Part 2.** Sweep oscillator set for an 18.6 to 20.0 GHz sweep.

In both tests, the sweep oscillator is eternally leveled at -5 dBm and the output signal is stored into the network analyzer's memory. The output is then connected to the HP 849B's RF INPUT and the network analyzer is connected to the RF OUTPUT. With the network analyzer set to the measurement minus memory mode, Minimum Small Signal Gain is read directly on the display.

Two separate tests are performed to measure unleveled output power. The first is done for a frequency range of 2.0 to 18.6 GHz and the second for 2.0 to 20.0 GHz. In both, the HP 8349B's minimum output power is determined by adjusting a frequency marker to the minimum power point on the network analyzer's swept display. The source is set up for CW at the marker frequency and then adjusted for exactly +5 dBm output power. The source is then connected to the HP 8349B's RF INPUT and the Unleveled Output Power is measured at the output with a power meter.

Leveled Output Power and Flatness are verified in the same test. The HP 8349B's DETECTOR OUTPUT is connected to the source's EXT ALC INPUT and leveling is selected. The amplifier's minimum power is found by manually sweeping the source while observing the power meter. The output power is then set for either +19 dBm or +16 dBm depending on the frequency range. The maximum power point is found in the same manner as above and the difference between the maximum and minimum is calculated to verify the flatness specification. Being able to level at +19 dBm for the 2.0 to 18.6 GHz range and +16 dBm for the 2.0 to 20.0 GHz range also verifies the Leveled Output Power specification.

## EQUIPMENT

Sweep Oscillator	HP 8350B
RF Plug-In	HP 83590A
Scalar Network Analyzer	HP 8757A
Detector	HP 11664B
Power Meter	HP 436A
Power Sensor	HP 8485A
Attenuator	HP 8493C Option 010
Detector	HP 8473C
Directional Coupler	HP P/N 0955-0125
Adapters:	
Type N (m) - 3.5 mm (f) (2 required)	HP P/N 1250-1744
Type N (m) - 3.5 mm (m)	HP P/N 1250-1743
Cables:	
SMA (m)	HP P/N 8120-3124
BNC (m) (48 in., 3 required)	HP 11170C
BNC (m) (24 in.)	HP 11170B

## PROCEDURE

### Small Signal Gain (2.0 to 18.6 GHz)

1. Connect the equipment as shown in Figure 4-1 with the coupler output connected to the 10 dB attenuator.
2. Set the network analyzer to display the power measured on the A input. Set the reference level to  $-15$  dBm and scale to 10 dB/DIV. Place the reference line on the center graticule.
3. Set up the sweep oscillator as follows:  
Start Frequency: 2.0 GHz  
Stop Frequency: 18.6 GHz  
Sweep Time: 0.5 sec  
Sweep Trigger: Internal  
Power Level:  $-5$  dBm  
ALC Mode: External  
27.8 KHz Square Wave Modulation: On  
Display Blanking: On  
  
Adjust the power level CAL to center the waveform on the  $-15$  dBm reference line.
4. Press the HP 8349B line switch on. Allow the equipment to warm up for 30 minutes.
5. Change the scale on the network analyzer to 1 dB/DIV and adjust the output power of the plug-in for the flattest waveform about the  $-15$  dBm reference (use the slope feature of the plug-in if necessary).
6. Store the waveform in the network analyzer's memory.
7. Connect the coupler to the HP 8349B RF INPUT and the 10 dB attenuator to the RF OUTPUT.

- Set the network analyzer to function DISPLAY then MEASUREMENT MINUS MEMORY and set the reference to +20 dB. Adjust the reference to place the minimum point of the waveform on the display. Determine the dB value of the minimum point (HP 8349B's minimum small signal gain). The measured value should be  $\geq 15$  dB.

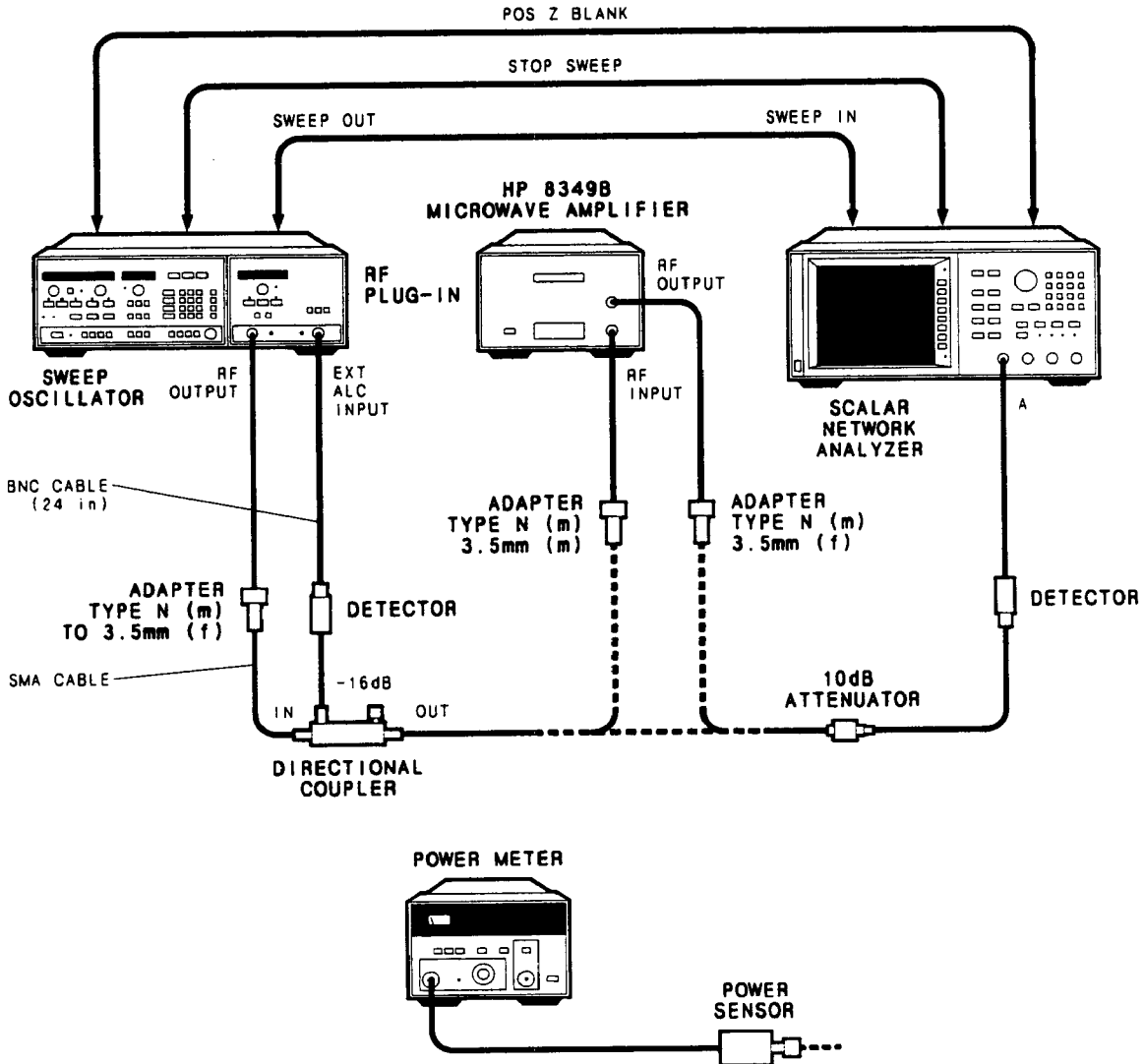

Figure 4-1. Small Signal Gain Test Setup

### **Small Signal Gain (18.6 to 20.0 GHz)**

9. Disconnect the HP 8349B RF INPUT and RF OUTPUT from the test setup. Connect the coupler output directly to the 10 dB attenuator.
10. Set the network analyzer to display the power measured on the A input. Set the reference level to  $-15$  dBm and scale to 10 dB/DIV. Place the reference line on the center graticule.
11. Set up the sweep oscillator as follows:

Start Frequency: 18.6 GHz  
Stop Frequency: 20.0 GHz  
Sweep time: 0.5 sec  
Sweep Trigger: Internal  
Power Level:  $-5$  dBm  
ALC Mode: External  
27.8 kHz Square Wave Modulation: On  
Display Blanking: On

Adjust the Power Level CAL to center the waveform on the  $-15$  dBm reference line.

12. Change the scale on the network analyzer to 1 dB/DIV and adjust the output power of the plug-in for the flattest waveform about the  $-15$  dBm reference (use the slope feature of the plug-in if necessary).
13. Store the waveform into the network analyzer's memory.
14. Connect the coupler to the RF INPUT of the HP 8349B and the 10 dB attenuator to the RF OUTPUT.
15. Set the network analyzer to function DISPLAY the MEASUREMENT MINUS MEMORY and set the reference to  $+20$  dB. Adjust the reference to place the minimum point of the waveform on the display. Determine the dB value of the minimum point (HP 8349B minimum small signal gain). The measured value should be  $>12$  dB.

### **Unleveled Output Power (2.0 to 18.6 GHz)**

16. Select dBm mode on the power meter and calibrate.
17. Reconnect the network analyzer to the output of the coupler as shown in Fig 4-1.
18. Set the network analyzer to display the power measured on the A input. Set the reference level to  $-5$  dBm and scale to 10dB/DIV.
19. Set the sweep oscillator's stop frequency to 18.6 GHz. Set the plug-in's output power to  $+5$  dBm and then adjust it to center the waveform on the network analyzer's reference line.
20. Change the scale on the network analyzer to 1 dB/DIV and readjust the output power of the plug-in for the flattest waveform about the reference (use the slope feature of the plug-in if necessary).
21. Store the waveform into memory.
22. Reconnect the coupler to the HP 8349B's RF INPUT and the network analyzer to the RF OUTPUT.
23. Set the network analyzer to display measurement minus memory and the reference to  $+15$  dB. Adjust the reference to place the minimum point of the waveform on the display.

24. Set one of the oscillator's frequency marker's to lowest point of the waveform displayed on the network analyzer. Select marker to center frequency and then select CW mode. This should set the sweep oscillator output frequency to the marker frequency. Turn the square wave modulation off.
25. Adjust the CAL FACTOR % on the power meter to the value given on the sensor for the frequency selected.
26. Disconnect the coupler from the HP 8349B and connect the power sensor to the coupler output. Adjust the plug-in's output power until the power meter measures +5.0 dBm.
27. Disconnect the power sensor, connect the attenuator to the coupler output and connect the power sensor to the attenuator. Determine the amount of attenuation.
28. Reconnect the coupler to the RF INPUT of the HP 8349B and the attenuator and power sensor to the RF OUTPUT. Add the amount of attenuation determined in step 27 to the dBm value now displayed on the power meter. The sum is the minimum output power with a +5 dBm input over the 2.0 to 18.6 GHz range and should be >20 dBm.

### **Unleveled Output Power (18.6 to 20 GHz)**

29. Reconnect the network analyzer to the output of the coupler as shown in Figure 4-1.
30. Set the network analyzer to display the power measured on the A input. Set the reference level to -5 dBm and scale to 10 dB/DIV.
31. Set the sweep oscillator's start frequency to 18.6 GHz and stop frequency to 20.0 GHz. Turn the 27.8 kHz squarewave modulation on. Set the plug-in's output power to -5 dBm and then adjust it to center the waveform on the network analyzer's reference line.
32. Repeat steps 20 through 27.
33. Reconnect the coupler to the RF INPUT of the HP 8349B and the attenuator to the RF OUTPUT. Add the amount of attenuation determined in step 27 to dBm value now displayed on the power meter. The sum is the minimum output power with a +5 dBm input over the 18.6 to 20.0 GHz range and should be > +18 dBm.

### **Leveled Output Power and Flatness (2 to 18.6 GHz)**

34. Connect the equipment as shown in Figure 4-2 with the power sensor connected to the HP 8349B's RF OUTPUT (attenuator not installed).
35. Set up the sweep oscillator as follows:
  - Start Frequency: 2.0 GHz
  - Stop Frequency: 18.6 GHz
  - Sweep: Manual
  - ALC Mode: External
  - Power Level: 19 dBm
  - Square Wave Modulation: Off

**NOTE:** In order to level the HP 8349B at 19 dBm it may be necessary to adjust the RF plug-in's front panel EXT ALC CAL adjustment.

36. While monitoring the power meter, adjust the manual frequency from 18.6 GHz to 2 GHz and determine the frequency of the minimum power point (minimum point will typically occur at the higher frequencies). Return the sweep oscillator to the frequency of the minimum power point.

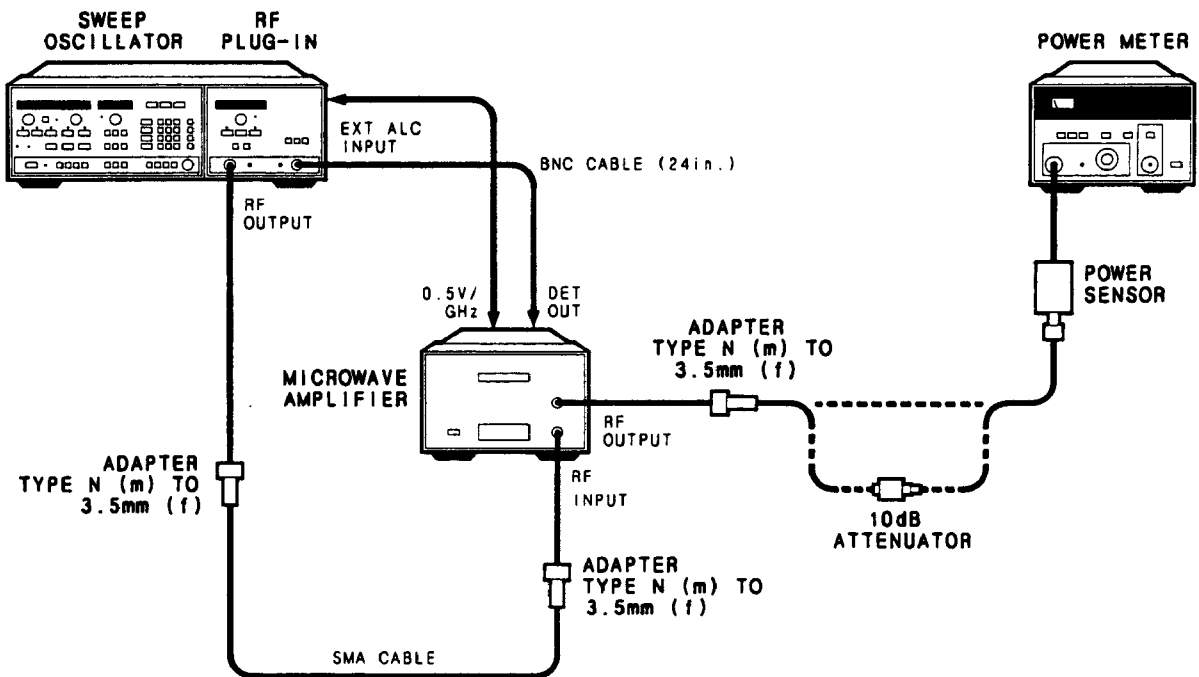

Figure 4-2. Levelled Output Power and Flatness Test Setup

37. Adjust the CAL FACTOR % on the power meter to the value given on the power sensor for the frequency selected and then adjust the output power of the plug-in for a +19 dBm power meter reading.
38. Connect the 10 dB attenuator between the adapter and the power sensor as shown in Figure 4-2. While monitoring the power meter, adjust the manual frequency from 2 to 18.6 GHz and determine the frequency of the maximum power point. Return the sweep oscillator to the frequency of the maximum power point.
39. Adjust the CAL FACTOR % on the power meter to the value given on the power sensor for the frequency selected. Subtract 9 dB from the value shown on the power meter to determine the leveling flatness of the HP 8349B. This value should be <2.5 dBm.
40. To meet leveling requirements, the unlevelled indicator on the RF plug-in should remain off during forward sweep. Set the sweep oscillator for a 5 second sweep from 2.0 to 18.6 GHz and verify that the unlevelled indicator remains off during forward sweep.

## Leveled Output Power and Flatness (2.0 to 20.0 GHz)

41. Connect the equipment as shown in Figure 4-2 with the power sensor connected to HP 8349B's RF OUTPUT (attenuator not installed).
42. Set up the sweep oscillator as follows:
  - Start Frequency: 2.0 GHz
  - Stop Frequency: 20.0 GHz
  - Sweep Time: Manual
  - ALC Mode: External
  - Power Level: +17 dBm
  - Square Wave Modulation: Off

**NOTE:** In order to level the HP 8349B at +17 dBm, it may be necessary to adjust the RF plug-in's front panel EXT ALC CAL adjustment.

43. While monitoring the power meter, adjust the manual frequency from 20 GHz to 2.0 GHz and determine the frequency of the minimum power point (minimum point will typically occur at the higher frequencies). Return the sweep oscillator to the frequency of the minimum power point.
44. Adjust the CAL FACTOR % on the power meter to the value given on the power sensor for the frequency selected and then adjust the output power of the plug-in for a +17 dBm power meter reading.
45. Connect the 10 dB attenuator between the adapter and the power sensor as shown in Figure 4-2. While monitoring the power meter, adjust the manual frequency from 2.0 GHz to 20 GHz and determine the frequency of the maximum power point. Return the sweep oscillator to the frequency of the maximum power point
46. Adjust the CAL FACTOR % on the power meter to the value given on the power sensor for the frequency selected. Subtract 9 dBm from the value shown on the power meter to determine the leveling flatness of the HP 8349B. This value should be <2.5 dB.
47. To meet leveling requirements, the unlevel indicator on the RF plug-in should remain off during forward sweep. Set the sweep oscillator for a 5 second sweep from 2.0 to 20.0 GHz and verify that the unlevel indicator remains off during forward sweep.



# VSWR

## SPECIFICATION

Frequency Range (GHz)	Input	Output (Leveled)
20 to 18.0	$\leq 2.8$	$\leq 2.5$

## DESCRIPTION

In the Input VSWR test, the equipment is set up as shown in Figure 4-3 and the network analyzer is set up for an A/R measurement. An open-short calibration is performed at the test port of the coupler and the calibration is stored into the network analyzer memory. The network analyzer memory is set for measurement minus memory and the amplifier is connected to the coupler. The dB value of the maximum point on the network analyzer is determined and this value is then converted to VSWR.

In the Output VSWR test, the 2.0 to 18.0 GHz frequency range is tested in four separate 4 GHz bandwidths. This is done to increase the resolution of the network analyzer display. The dual directional coupler is set up as a single directional coupler and then a load is placed on the end of the air line (see Figure 4-3) to prevent any reflections from being seen at the coupled port. The signal at the end of the coupled port is then stored into the network analyzer memory. A short is then placed on the air line, the network analyzer is set to display measurement minus memory, and the maximum change in power is measured. Systems errors are corrected by measuring the system loss in one direction and multiplying that number by two. Finally, through several calculations, the VSWR of the amplifier is determined.

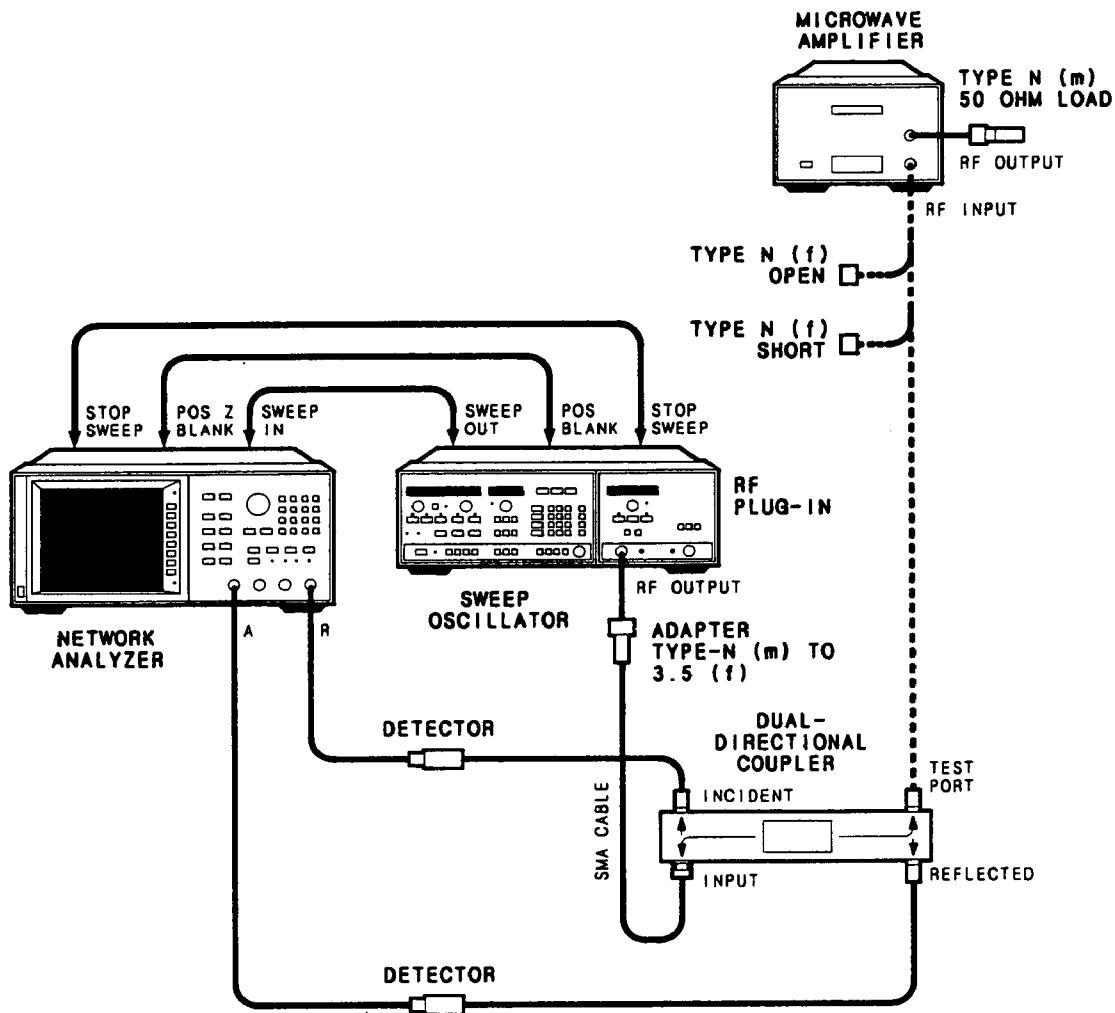

Figure 4.3 Input VSWR Test Setup (Unleveled)

## EQUIPMENT

Sweep oscillator	HP 8350B
RF Plug-In	HP 83590A
Scalar Network Analyzer	HP 8757A
Detector (2 required)	HP 11664A
Dual Directional Coupler	HP 1169- Option 002
20 cm Air Line (2 required)	HP 11567A
Type-N (f) Short	HP 11511A
Type-N (f) Open	HP P/N 85032-20001
Type-N (m) 50 Ohm Load	HP 909A Option 012
APC-7 Short	HP 11565A
APC-7 50 Ohm Load	HP 909A
Adapters:	
Type-N (m)-APC-7	HP 11525A
APC-7-APC-3.5 (f)	HP P/N 1250-1747
Type-N (m)-APC-3.5 (f) (3 required)	HP P/N 1250-1744
Cables:	
Type-N (m) (24in.)	HP 11500B
BNC (m) (48 in., 3 required)	HP 11170C
BNC (m) (24 in.)	HP 11170B
SMA (m)	HP P/N 8120-3124

## PROCEDURE

### Input VSWR

1. Connect the equipment as shown in Figure 4-3 with the short connected to the coupler's Test Port.
2. Set the sweep oscillator as follows:

Start Frequency: 2.0 GHz  
Stop Frequency: 18.0 GHz  
Sweep Time: 1 sec  
Sweep Trigger: Internal  
27.8 kHz Square Wave Modulation: On  
Display Blanking: On  
Power Level: 5 dBm  
ALC Mode: Internal

3. Set the network analyzer as follows:

Channel 1: On  
Channel 2: Off  
Measure: A/R  
Display: Measurement  
Scale: 5 dB/DIV  
Reference Level: 0 dB

4. Press the HP 8349B LINE switch on. Allow the equipment to warm up for 30 minutes.

**NOTE:** In steps 5 and 6, an open-short calibration is performed. The HP 8757A has a special CAL function incorporated which automatically stores the calibration information into memory when the calibration is complete. Use this feature when performing steps 5 and 6.

5. Perform a short calibration.
6. Connect the open to the Test Port of the coupler and perform an open calibration.
7. Connect the Test Port of the coupler to the HP 8349B RF INPUT. Set the network analyzer to display input minus memory and adjust the reference to place the waveform onto the display.
8. Determine the dB value of the maximum point on the waveform and use the following formula to calculate the VSWR. The VSWR should be  $\leq 2.8$ .

$$\text{VSWR} = 10^{(-X/20)}$$

where x = the dB value of the maximum point.

### Output VSWR

9. Connect the equipment as shown in Figure 4-4 with the load connected to the air line.

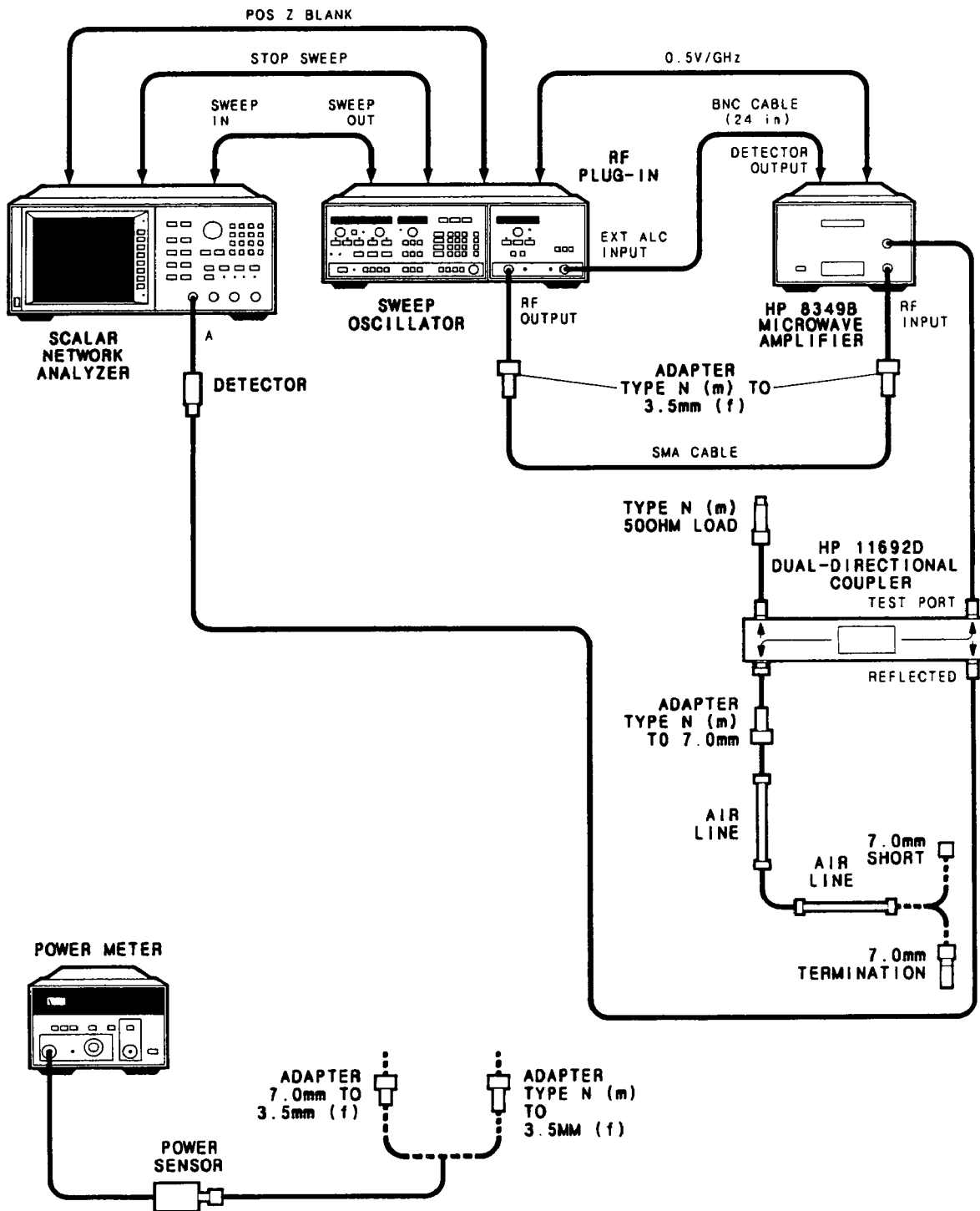

Figure 4-4. Output VSWR Test Setup (Levelled)

10. Set the sweep oscillator as follows:

Start Frequency: 2.0 GHz  
 Stop Frequency: 6.0 GHz  
 Sweep Time: 0.5 sec  
 Sweep Trigger: Internal  
 ALC Mode: External  
 Power Level: 15 dBm  
 Display Blanking: On  
 27.8 kHz Square Wave Modulation: On

**NOTE:** To level the output power of the HP 8349B, it may be necessary to adjust the RF plug-in front panel EXT ALC CAL adjustment. Ensure that the RF plug-in unlevelled light remains off during forward sweep before continuing with this test.

11. Set up the network analyzer to measure the power on the A input. Center the waveform on the display and then store it into memory.
12. Connect the short to the air line as shown in Figure 4-4 and set the network analyzer to display measurement minus memory.
13. A ripple waveform should now be displayed on the network analyzer. Find the point where the greatest peak to peak variation occurs (adjacent minimum to maximum) and determine the dB change from the minimum (should be a positive number). Enter the dB change onto Table 4-1 in the column labeled dB.

*Table 4-1. Output SWR Test Data*

Frequency Range (GHz)		$\Delta$ dB (dB)	MSL (dB)
Start	Stop		
2.0	6.0		
6.0	10.0		
10.0	14.0		
14.0	18.0		

14. Center a frequency marker between the maximum and minimum points. Set the sweep oscillator to CW mode and enter the marker frequency.
15. Set the power meter mode to dBm and calibrate. Set the CAL FACTOR% on the power meter to the value given on the power sensor for the frequency selected.
16. Disconnect the short and connect the power sensor to the air line. Turn the 27.8 kHz square wave modulation off and note the power level.
17. Disconnect the coupler and connect the power sensor to the HP 8349B RF OUTPUT. Note the power level.
18. Subtract the power level measured in step 16 from the level measured in step 17. The difference is the loss of the measurement system (MSL). Enter the value onto Table 4-1.
19. Repeat steps 9 through 18 for the frequency ranges in Table 4-1.

20. Using the data entered in Table 4-1 for the 2.0 to 6.0 GHz frequency range, perform the following calculations to determine the output VSWR of the HP 8349B.

a. Convert  $\Delta\text{dB}$  to measured VSWR ( $\text{VSWR}_M$ ) using the following equation:

$$\text{VSWR}_M = 10^{+(\Delta\text{dB}/20)}$$

$$\text{VSWR}_M = \underline{\hspace{2cm}}$$

b. Convert  $\text{VSWR}_M$  to the measured reflection coefficient ( $\rho_M$ ) using the following equation:

$$\rho_M = \frac{\text{VSWR}_M - 1}{\text{VSWR}_M + 1}$$

$$\rho_M = \underline{\hspace{2cm}}$$

c. Convert MSL to the reflection coefficient of the test system ( $\rho_{TS}$ ) using the following equation:

$$\rho_{TS} = 10^{-2(\text{MSL}/20)}$$

$$\rho_{TS} = \underline{\hspace{2cm}}$$

d. Calculate the reflection coefficient of the HP 8349B ( $\rho_A$ ) using the following equation:

$$\rho_A = \rho_M / \rho_{TS}$$

$$\rho_A = \underline{\hspace{2cm}}$$

e. Calculate the output VSWR of the HP 8349B ( $\text{VSWR}_A$ ) using the following equation and then enter the value onto Table 4-2 in the 2.0 to 6.0 GHz Frequency Range column.

$$\text{VSWR}_A = \frac{1 + \rho_A}{1 - \rho_A}$$

$$\text{VSWR}_A = \underline{\hspace{2cm}}$$

Table 4-2. Output VSWR Test Results

Frequency Range	2.0 to 6.0	6.0 to 10.0	10.0 to 14.0	14.0 to 18.0
VSWR				

21. Repeat step 20 using the data entered in table 4-1 for all of the frequency ranges.

22. The largest value entered for VSWR in Table 4-2 is the HP 8349B's worst case VSWR. This value should be  $\leq 2.5$ .

# SPECTRAL PURITY

## SPECIFICATION

Fundamental Frequency (GHz)	Harmonics (dBc, at 20 dBm Output Power)	Non-Harmonic Spurious
2.0 to 11.0	$\leq -20$	$\leq -55$ dBc

## DESCRIPTION

In the Harmonics test, the HP 8349B is tested over the frequency range where the harmonic content is the greatest (3.2 to 6.3 GHz). Initially, the test system is calibrated by sweeping the source from 6.4 to 12.6 GHz and storing a calibration line into the spectrum analyzer's memory. The calibration line is then set to 0 dB in order to allow the harmonic content to be read directly in dBc. The spectrum analyzer is set for measurement minus memory and the source is swept from 3.2 to 6.3 GHz. After several sweeps, the harmonic level (in dBc) is read directly from the spectrum analyzer.

In the Non-Harmonic Spurious test, a frequency of interest is selected and then the spectrum analyzer is tuned from 2.0 to 22.0 GHz while looking for spurious responses.

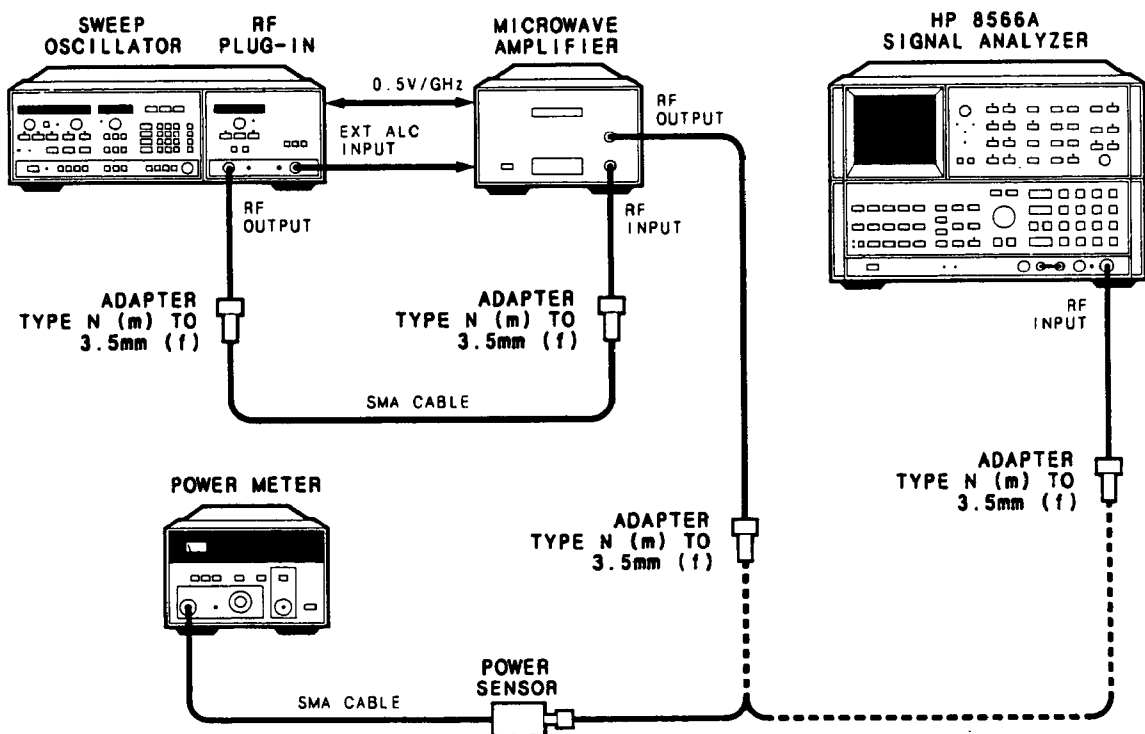

Figure 4-5. Spectral Purity Test Setup

## EQUIPMENT

Sweep Oscillator .....	HP 8350B
RF Plug-in .....	HP 83592C
Spectrum Analyzer .....	HP 8566B
Power Meter .....	HP 436A
Power Sensor .....	HP 8485A
Adapter	
Type N (m) - APC-3.5 (f) (4 required) .....	HP p/n 1250-1744
Cables	
SMA (m) (2 required) .....	HP p/n 8120-3124
BNC (m) (24 in.) .....	HP 11170B

## PROCEDURE

### Harmonics

1. Switch the equipment off and then connect it as shown in Figure 4-5 with the HP 8349B's RF OUTPUT connected to the spectrum analyzer.
2. Switch the spectrum analyzer on and then set it as follows:

Start Frequency: 6.4 GHz  
Stop Frequency: 12.6 GHz  
Reference Level: 20 dBm  
RF Input Attenuation: 30 dB  
Scale: 5 dB/DIV

3. Set up the sweep oscillator as follows:

CW: 12.6 GHz  
Sweep Time: 100 sec  
Sweep Trigger: Single  
RF Blanking: On  
Display Blanking: On  
ALC Mode: External  
Power Level: 7 dBm

4. Switch the HP 8349B LINE on. Allow the equipment to warm up for 30 minutes.
5. Adjust the output power of the RF plug-in until the display on the HP 8349B reads 19.0 dBm. Set the sweep oscillator's start frequency to 6.4 GHz and stop frequency to 8.4 GHz.
6. Set the spectrum analyzer to blank channel A. Clear channel B and then select maximum hold.
7. Press single sweep on the sweep oscillator.
8. At the end of the sweep, change the sweep oscillator's start frequency to 8.4 GHz and stop frequency to 10.4 GHz. Press single sweep.
9. At the end of the sweep, change the sweep oscillator's start frequency to 10.4 GHz and stop frequency to 12.6 GHz. Press single sweep.



10. At the end of the sweep, a trace with some small power dropouts should be displayed on the spectrum analyzer. To remove them, set channel A on the spectrum analyzer to write and set the sweep oscillator to CW. Adjust the frequency of the sweep oscillator to the points where the dropouts occur. When the sweep oscillator frequency equals a dropout frequency, the dropout should be removed.
11. On the spectrum analyzer, blank channel A and then select enter display line. Set the display line to 0 dBm and then select channel B minus display line. Set the spectrum analyzer to display channel A minus channel B. Blank channel B and select a reference level of 0 dBm.
12. Set the sweep oscillator as follows:
  - Start Frequency: 3.2 GHz
  - Stop Frequency: 6.3 GHz
  - Sweep Trigger: Internal
13. On the spectrum analyzer, clear channel A and then set it for maximum hold. Allow the sweep oscillator to sweep three times through the frequency range set in step 12.
14. Adjust the spectrum analyzer's frequency marker from 6.4 to 12.6 GHz. Determine the dBm value and frequency of the maximum point. The measured value should be  $< -20$  dBm (due to the calibration performed in previous steps, the measured value converts directly to dBc).
15. If the maximum harmonic level measured in step 14 is within specification, proceed to step 24. If the test failed, proceed to step 16.
16. Select CW mode on the sweep oscillator and enter the frequency of the harmonic that exceeds the specification. Enter a power level of 10 dBm.
17. Calibrate the power meter and set the CAL FACTOR % to the value given on the power sensor for the frequency selected. Connect the power sensor to the HP 8349B RF OUTPUT. Note the power meter reading.
18. Set the sweep oscillator frequency to one-half of the harmonic frequency if it is the second harmonic that exceeds specification, or one-third the harmonic frequency if it is the third harmonic.
19. Adjust the CAL FACTOR % on the power meter to the value given on the power sensor for the frequency selected. Adjust the power level of the RF plug-in for a power meter reading of 19.0 dBm.
20. Disconnect the power sensor and reconnect the spectrum analyzer to the HP 8349B's RF OUTPUT. Clear channel A on the spectrum analyzer and note the power level of the harmonic.
21. Repeat step 16.
22. Measure the power level on spectrum analyzer. Calculate the insertion loss of the test system by subtracting the power level measured in this step from the power level noted in step 17 (insertion loss = power level step 17 minus power level step 22).
23. Determine the power level of the harmonic by adding the insertion loss calculated in step 22 to the power level noted in step 20. Subtract 19 from the sum to determine the power level of the harmonic in dBc. The difference should be  $< -20$  dBc.

## Non-Harmonic Spurious

24. Set the sweep oscillator to a CW frequency of interest. Connect the power sensor to the RF OUTPUT of the HP 8349B and adjust the output power of the plug-in until the power meter reads 19.0 dBm.
25. Reconnect the spectrum analyzer to the HP 8349B's RF OUTPUT and tune the spectrum analyzer from 2.0 to 22.0 GHz. Look for any spurious responses. When one is found, determine if it is harmonically or non-harmonically related. If non-harmonically related, the spurious signal should be  $< -55\text{dBc}$ .

Table 4-3. HP 8349B Test Record

Hewlett-Packard HP 8439B Microwave Amplifier		Date_____		
Serial Number_____		Tested by_____		
Humidity*_____		Temperature*_____		
*Optional				
Specification Tested	Step	Test Conditions	Specification	Measured Value
4-10. Small Signal Gain	8	Frequency Range: 2.0 to 18.6 GHz Input Power: -5 dBm	15 dB	_____dB
4-10. Small Signal Gain	15	Frequency Range: 18.6 to 20.0 GHz Input Power: -5 dBm	12 dB	_____dB
4-10. Uneveled Output Power	28	Frequency Range: 2.0 to 18.6 GHz Input Power: +5 dBm	20 dBm	_____dBm
4-10. Uneveled Output Power	33	Frequency Range: 18.6 to 20.0 GHz Input Power: +5 dBm	18 dBm	_____dBm
4-10. Output Power Flatness, Leveled	39	Frequency Range: 2.0 to 18.6 GHz Minimum Output: 19 dBm	$\pm 1.25$ dB	_____dB pk-pk
4-10. Output Power Flatness, Leveled	46	Frequency Range: 2.0 to 20 GHz Minimum Output: 17 dBm	+1.25 dB	_____dB pk-pk
4-11. Input VSWR	8		$\leq 2.8$	_____
4-11. Output VSWR	22	Output Power 19 dBm, Leveled	$\leq 2.5$	_____
4-12. Spectral Purity: Harmonics	14	Output Power: 19 dBm, Leveled	$\leq 20$ dBc	_____dBc
4-12. Spectral Purity: Harmonic Spurious	25	Output Power: 19 dBm, Leveled	$\leq 55$ dBc	_____dBc



## Section 5. Adjustments

---

### INTRODUCTION

This section provides adjustment procedures for the HP 8349B Microwave Amplifier. These procedures should not be performed as routine maintenance but should be used after replacement of a part or a component, or when performance tests show that the specifications listed in Table 1-1 cannot be met. Table 5-1 lists the adjustment procedures described in this section. Table 5-2 lists all the adjustable components by reference designators and adjustment name.

In the procedure instructions, the word "press" will be used when referring to front panel hardkeys (**HARDKEY**) and "select" will be used when referring to softkeys (**SOFTKEY**) displayed by the Cathode Ray Tube (hereafter referred to as CRT) located in the front panel.

**NOTE:** Allow the HP 8349B to warm up for 30 minutes prior to making any adjustments. A non-metallic adjustment tool is recommended.

### SAFETY CONSIDERATIONS

Although this instrument has been designed in accordance with international safety standards, this manual contains information, cautions, and warnings that must be followed to ensure safe operation and to retain the instrument in a safe condition. Adjustments and service should be performed only by a skilled person who is aware of the hazards involved.

#### WARNING

**Adjustments in this section are performed with power supplied to the instrument with protective covers removed. The voltages present in the instrument can, if contacted, cause personal injury. Be extremely careful. Adjustments should be performed only by a skilled person aware of the hazards involved.**

### EQUIPMENT REQUIRED

The equipment required for the adjustment procedures is listed in Section 1 of this manual. If the test equipment recommended is not available, other equipment may be substituted if its performance meets the critical specifications listed in the table. The equipment required for each adjustment is specified in that procedure.

## RELATED ADJUSTMENTS

All adjustments in the HP 8349B are interrelated. If an adjustment is required, perform all the adjustment procedures in the sequence provided here.

**NOTE:** Although the A3 contains potentiometers, it should be adjusted **ONLY IF THE BIAS ASSEMBLY IS REPLACED OR SERVICED. Do not perform any adjustments on the A3 if A2 and A3 are replaced as a set. You can find repair and adjustment information in Section 8, "A2 Amplifier and A3 Bias Board, Troubleshooting."**

*Table 5-1. Adjustment Procedures*

Adjustment	Procedure
1	+5 Vdc, +8 Vdc, +15 Vdc, and -15 Vdc Power Supply Adjustments.
2	Compensation Zero Adjustments
3	Display Adjustment
4	Exponential Adjustment
5	Dual Slope Log Adjustments
6	Flatness Compensation Adjustment

*Table 5-2. Adjustable Components*

Reference Designation	Adjustment Name	Description
A5R38	+5 Vdc ADJ	Adjusts the DC voltage at the output of voltage regulator U2 to +5 Vdc.
A5R35	+8 Vdc ADJ	Adjusts the DC voltage at the output of voltage regulator U1 to +8 Vdc.
A5R39	+15 Vdc ADJ	Adjusts the DC voltage at the output of Voltage Regulator U3 to +15 Vdc.
A5R36	-15 Vdc ADJ	Adjusts the DC voltage at the output of Voltage Regulator U4 to -15 Vdc.
A4R81	OFFSET	Display offset adjustment.
A4R79	GAIN	Display gain adjustment.
A4R89	DET OUT	Exponential amp adjustment.
A4R21	0	Log Amp Adjustment, 0 dBm.
A4R34	-10	Log Amp Adjustment, -10 dBm.
A4R14	-20	Log Amp Adjustment, -20 dBm.
A4R23	+15	Log Amp Adjustment, +10, +20 dBm.
A4R67-R60	C1-C8	Flatness compensation adjustment.

# POWER SUPPLY ADJUSTMENTS

## REFERENCE

A5 Regulator Assembly

## DESCRIPTION

The +5 Vdc, +8 Vdc, +15 Vdc, and -15 Vdc power supplies are adjusted to their correct levels.

## EQUIPMENT

Digital Voltmeter (DVM) .....	HP 3456A
Microwave Amplifier .....	HP 8349B

## PROCEDURE

1. Configure test setup as in Figure 5-1.

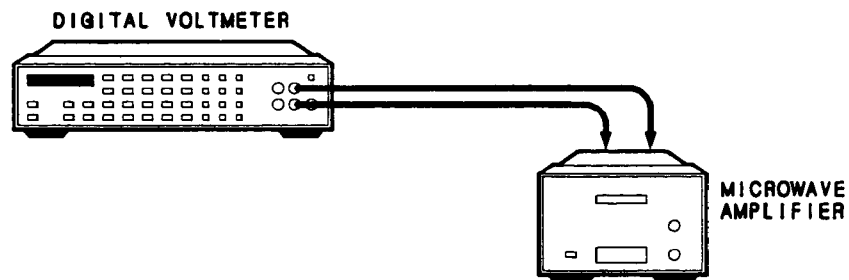
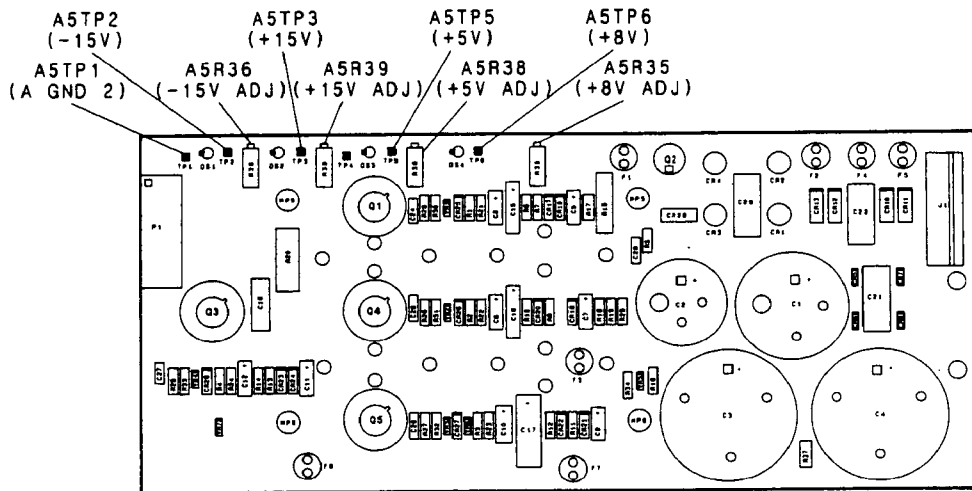

Figure 5-1. Power Supply Adjustment Setup

### + 5 Vdc

2. With the LINE power off, remove the top cover of the HP 8349B as follows: remove the screw from the rear cover-strip of the carrying handle; slide the top cover back to expose the cover's front edge, and lift it off.
3. Switch on the LINE power and allow the instrument to warm up for at least 30 minutes.
4. With the DVM in DC coupled mode, connect the DVM LO terminal to A5TP1 (A GND 2) and the HI terminal to A5TP5 (+5V). Refer to Figure 5-2 for A5 power supply assembly adjustment locations.

## A5



**Figure 5-2. Power Supply Assembly Adjustment Locations**

5. Adjust A5R38 (see Figure 5-2) for a DVM reading of  $+5.000 \pm .001$  Vdc.

### **+8 Vdc**

6. Connect the DVM HI terminal to A5TP6 (+8V).
7. Adjust A5R35 for a DVM reading of  $+8.000 \pm .001$  Vdc.

### **+15 Vdc**

8. Connect the DVM HI terminal to A5TP3 (+15V).
9. Adjust A5R39 for a DVM reading of  $+15.000 \pm .001$  Vdc.

### **-15 Vdc**

10. Connect the DVM HI terminal to A5TP2 (-15V).
11. Adjust A5R36 for a DVM reading of  $-15.000 \pm .001$  Vdc.

# INITIAL SETUP FOR COMPENSATION ZERO, DISPLAY, EXPONENTIAL, AND DUAL SLOPE LOG ADJUSTMENTS

## EQUIPMENT NEEDED

Sweep Oscillator .....	HP 8350B
RF Plug-in .....	HP 83590A
Microwave Amplifier .....	HP 8349B
DVM .....	HP 3456A
Power Meter .....	HP 436A
Programmable Attenuator .....	HP 8495B
Power Sensor .....	HP 8485A

Connect the test equipment as shown in Figure 5-3.

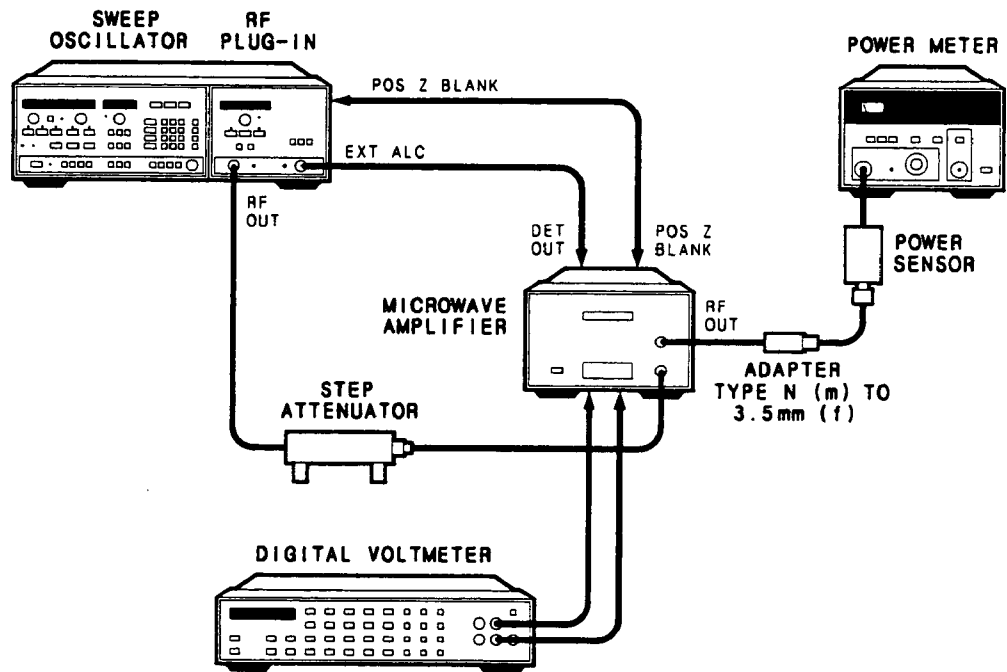

Figure 5-3. Adjustment Setup



# COMPENSATION ZERO ADJUSTMENT

## REFERENCE

A4 Signal Conditioning Board

## DESCRIPTION

The adjustment of A4R67 (C1) for 0.00V from the flatness compensation circuitry nulls the effects of this circuit before adjustment of the log amp is performed.

## PROCEDURE

1. On the HP 8350B, press **CW** **11** **GHz**.
2. On the HP 83590A, set RF output power to  $-5$  dBm. Press **POWER LEVEL** **-** **5** **dBm**.
3. On the HP 8350B, press **RF** and **CW** (LEDs on).
4. On the HP 83590A, press **ALC MODE** **INT** to turn internal ALC mode on.
5. Center resistors, R67 through R60 (C1 through C8) on the A4 Signal Conditioning Board in the HP 8349B. See Figure 5-4.
6. Connect DVM LO to A4TP4 (-) and DVM HI to A4TP5 (COMP). See Figure 5-4.
7. Set the HP 8495B programmable attenuator to 20 dB.
8. Ensure that 0.5V/GHz located on the back panel of the HP 8349B is not connected. It will affect the accuracy of this test.
9. Adjust A4R67 (C1) for a  $0.000 \pm .001V$  reading on the DVM.

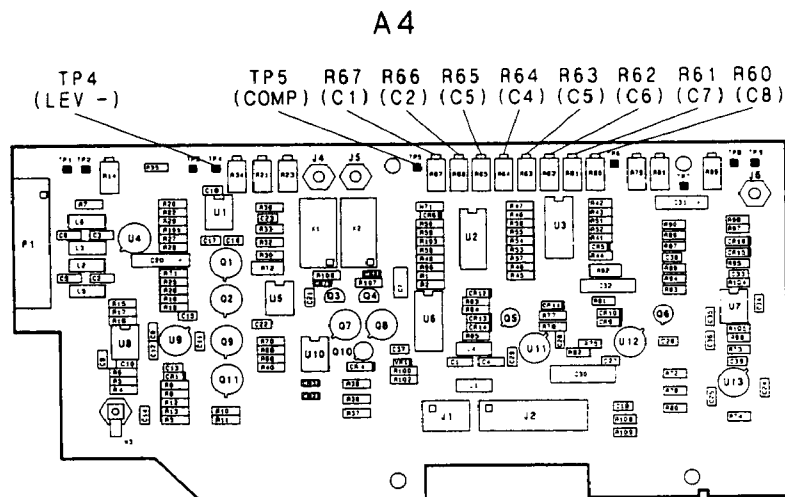

Figure 5-4. Compensation Zero Adjustment Location

# DISPLAY ADJUSTMENT

## REFERENCE

A4 Signal Conditioning Board

## DESCRIPTION

This adjustment sets a 60mV/dB display response ( $0.00V = 0.00 \text{ dB}$  /  $1.20V = 20.0 \text{ dB}$ ) for the display driver circuitry.

## PROCEDURE

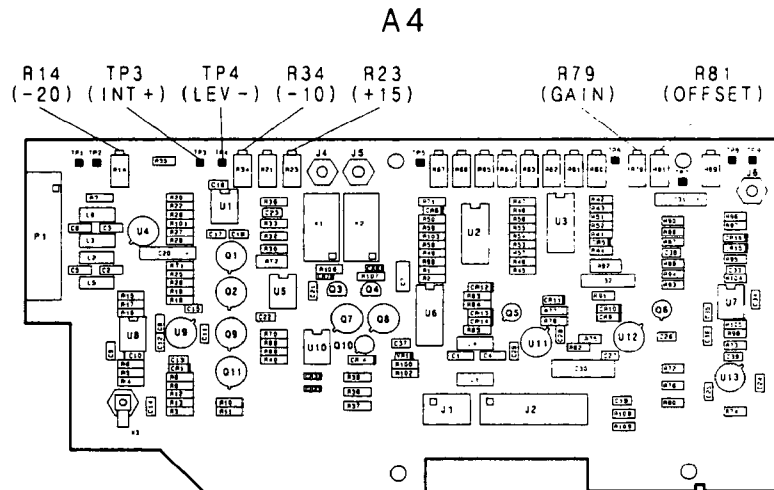

Figure 5. Display Adjustment Location

1. Connect DVM LO to A4TP4 (-) and DVM HI to A4TP3 (+). See Figure 5-5.
2. Center A4R14 (-20), A4R23 (+15), and A4R34 (-10) resistors.
3. Set the HP 8495B programmable attenuator to 20 dB. Adjust the HP 83590A RF output power for a reading of  $0.000 \pm .001V$  on the DVM.
4. Adjust A4R81 (OFFSET) for a 0.0 dBm reading (with a blinking minus sign) on the HP 8349B Power Level Display. Ensure that A4TP3 remains at 0V during this adjustment. If not, readjust the HP 83590A power level with the rotary knob.
5. Set the HP 8495B programmable attenuator to 0 dB. Adjust the HP 83590A RF output power for a reading of  $+1.200 \pm .003V$  on the DVM.
6. Adjust A4R79 (GAIN) for a 20.0 dBm  $\pm 0.1 \text{ dB}$  reading on the HP 8349B display. Ensure that A4TP3 remains at  $+1.200 \pm .003V$ . If not, readjust the HP 83590A output power with the rotary knob.

# EXPONENTIAL ADJUSTMENT

## REFERENCE

A4 Signal Conditioning Board

## DESCRIPTION

The DET OUT adjustment sets the initial level of the exponential amplifier (DET OUT) for use with the HP 83590 series RF plug-ins during external ALC mode.

## PROCEDURE

1. Connect DVM LO to A4TP4 (–) and DVM HI to A4TP3 (+). See Figure 5-6.
2. Adjust the HP 83590A RF output power for a  $1.200 \pm .003V$  reading on the DVM and a 20.0 dBm reading on the HP 8349B display.
3. Connect DVM LO to A4TP9 (–) and DVM HI to A4TP8 (+).
4. Adjust A4R89 (DET OUT) for  $-0.315 \pm .01V$ .

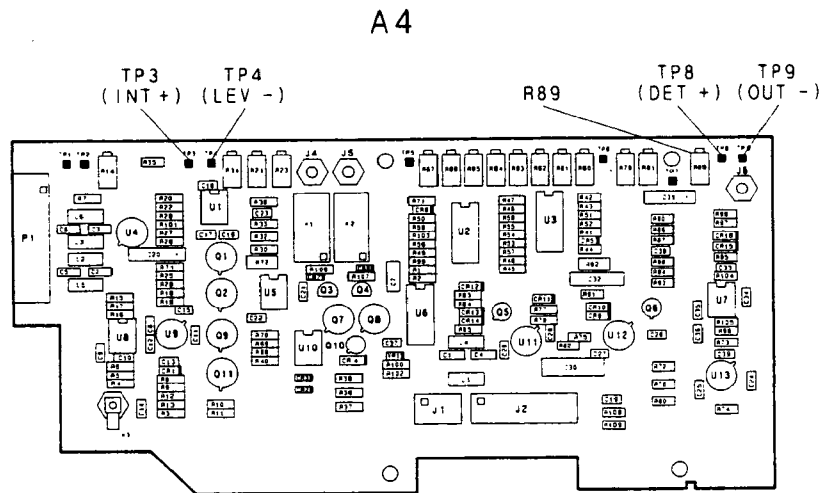

Figure 5-6. Exponential Adjustment Location

# DUAL SLOPE LOG ADJUSTMENTS

## REFERENCE

A4 Signal Conditioning Board

## DESCRIPTION

These adjustments provide calibrated power display accuracy by linearizing the logarithmic response curve of the internal detector to the Power Level Display. Adjustments (R14, R21, R23, and R34) deal with four power points on the curve,  $-10$  dBm,  $0$  dBm,  $+10$  dBm, and  $+20$  dBm, setting each of them within  $0.3$  dBm of their displayed values.

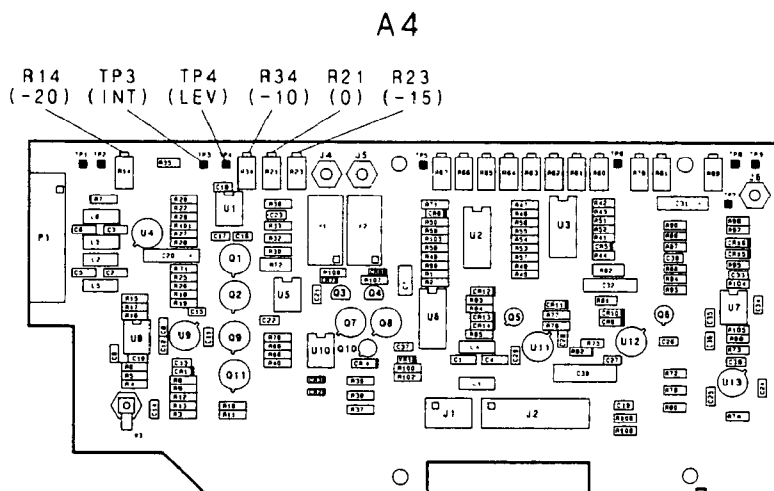

Figure 5-7. Dual Slope Log Adjustment Location

## PROCEDURE

1. On the HP 83590A, press **(RF)** to off.
2. Adjust A4R34 ( $-10$ ) fully clockwise. See Figure 5-7.
3. On the HP 3456A, use AC Mode and Auto Ranging.
4. Connect DVM LO to A4TP4 ( $-$ ) and DVM HI to A4TP3 ( $+$ ).
5. Adjust A4R14 ( $-20$ ) for a maximum noise voltage (typically  $70$  mV).
6. On the HP 436A, set the CAL FACTOR % for  $11.0$  GHz. The correct compensation factor can be found on the HP 8485A power sensor.
7. On the HP 83590A, press **(RF)** to on.

8. Table 5-3 lists the settings and adjustments the proper test equipment and the HP 8349B requires to set a linear response from the dual slope logarithmic amplifier. This table (adjustment points A-D) corresponds to the logarithmic amplifier response graph (shown in Figure 5-8). Ideally, the amplifier's response would be flat across the graph but deviation does occur. Adjustments A4R14, 14, 23, and 34 optimize this response.

Table 5-3. Dual Slope Logarithmic Amplifier Adjustments

Adjustment Points	HP 8495B Attenuator	HP 436A Reading	HP 8350B Register	A4 Adjustment	HP 8349B Power Level Display
A	20 dB	20.0dBm	SAVE n 1	A4R21(0)	0.0 ± 0.3 dBm
B	30 dB	-10.0 dBm	SAVE n 2	A4R34 (-10)	10.0 ± .3 dBm
C	0 dB	20.0 dBm	SAVE n 3	A4R23 (+15)	20.0 ± .3 dBm
D	10 dB	10.0 dBm	SAVE n 4	A4R23 (+15)	10.0 ± .3 dBm

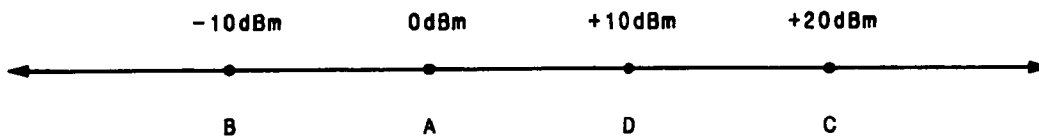

Figure 5-8. Logarithmic Amplifier Response Graph

9. Adjustment point A in Table 5-3 is performed as follows:
- Set the HP 8495B programmable attenuator to 20 dB. Adjust the HP 83590A RF output power. Press **(POWER LEVEL)** and rotate the rotary knob on the RF Plug-in for a 0.00 dBm reading on the HP 436A.
  - Save these settings in Register 1, press **(SAVE n)** **(1)** on the HP 8350B. When saved, these settings can be easily recalled if point A requires readjustment.
  - Adjust A4R21 (0) for a 0.0 dBm reading on the HP 8349B display. This sets the 0 dBm point at 0 dBm on the response graph.
10. For Adjustment points B and C, repeat step 9 (a - c) using the settings listed in Table 5-3. Make a copy of the Logarithmic Response Graph (Figure 5-8), and plot the response curve for points A, B, and C. It should look similar to the response curve in Figure 5-9.

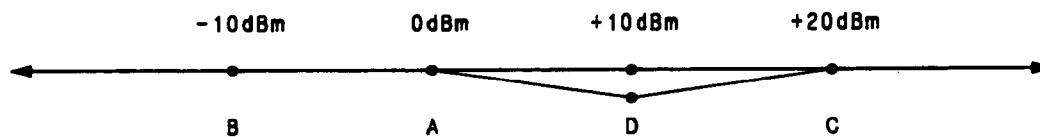

Figure 5-9. Typical Response Curve

11. For adjustment point D, follow the settings in Table 5-3.
- Set the HP 8495B programmable attenuator to 20 dB. Adjust the HP 83590A RF output power. Press **(POWER LEVEL)** and rotate the rotary knob on the RF Plug-in for a +10.0 dBm reading on the HP 436A.
  - Save these settings in Register 4. Press function **(SAVE n)** **(4)** on the HP 8350B.

- Before adjusting A4R23 (+15), note the difference from the optimum +10 dBm point. Iterate between adjustment point C and point D to optimize the high end of the response curve. A4R23 affects both the +10 dBm and +20 dBm points.

For example: If the +10 dBm point is at +9.9 dBm and the +20 dBm point is at +20.3 dBm, A4R23 (+15) must be adjusted to provide an equal offset at both of these points and their linear responses. Therefore, adjust A4R23 (+15) so that the +10 dBm point reads +9.8 dBm and the +20 dBm point reads +20.2 dBm. The curve should resemble Figure 5-10. Note that the +20 dBm point and the +10 dBm point have been optimized for an equal offset from their ideal power points.

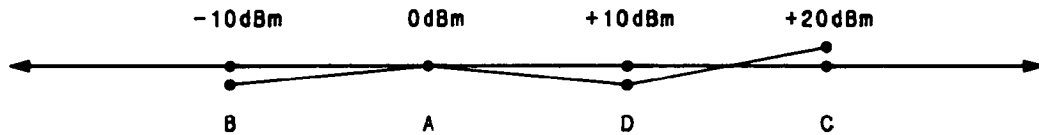

Figure 5-10. Typical Response Curve with Initial Adjustments A-D

- Set the HP 8495B programmable attenuator to 30 dB. On the HP 8350B press **RECALL** (2). On the HP 83590A, select **[POWER LEVEL]** and adjust the rotary knob for a -10.0 dBm reading on the HP 436A.
- Note the power level displayed on the HP 8349B and record the actual difference from the ideal -10 dBm point. This difference will be added to the next power point (+10 dBm) for optimization.
- Set the HP 8495B programmable attenuator to 10 dB. On the HP 8350B, press function **RECALL** (4). On the HP 83590A, select function **[POWER LEVEL]** and adjust the rotary knob for a +10.0 dBm reading on the HP 436A.
- Note the power level displayed on the HP 8349B. Using A4R23 (+15), adjust the level to read +10.0 dBm plus the difference noted in step 14. For example: if the initial reading for the +10 dBm point on the HP 8349B is 9.8 dB and the difference noted in step 14 is 0.2 dB, adjust it to +10.0 dB (9.8 + 0.2). If the difference from step 14 is 0.3 dBm, adjust A4R23 (+15) to read 10.3 dBm (10.0 + 0.3). This helps adjust the entire logarithmic curve for a more linear response. The curve should now resemble Figure 5-11.

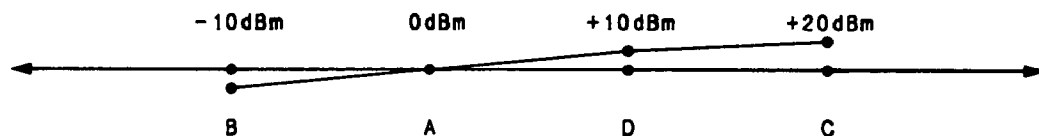

Figure 5-11. Linear Response Curve

- Set the HP 8495B programmable attenuator to 30 dB. On the HP 8350B, press **RECALL** (2). On the HP 83590A, select **[POWER LEVEL]** and adjust the rotary knob for a -10.0 dBm reading on the HP 436A.
- Adjust A4R34 (-10) for a -10.0 dBm reading on the HP 8349B Power Level Display.
- For remaining adjustment points D (+10 dBm) and C (+20 dBm), follow Table 5-4. Iterate between both of these points as in step 11 and 12 for an optimum response. This final step will in affect rotate the entire curve around the 0 dBm point. The response should resemble Figure 5-12.

Table 5-4. Final 10.0 dBm and 20.0 dBm Adjustments

Adjustment Points	HP 8495B Attenuator	HP 436A Reading	HP 8350B Register	A4 Adjustment	HP 8349B Power Level Display
C	20 dB	20.0 dBm	RECALLn 3	A4R23 (+ 15)	20.0 ± .3 dBm
D	10 dB	10.0 dBm	RECALLn 4	A4R23 (+ 15)	10.0 ± .3 dBm

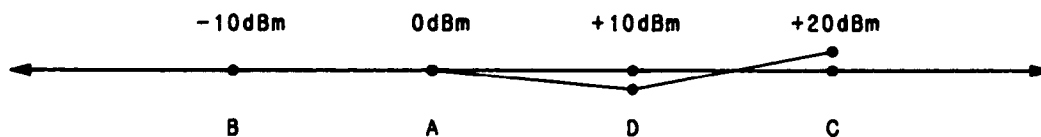

Figure 5-12. Final Response Curve

- Confirm that all adjustment points A - D are within  $\pm 0.3$  dBm of their ideal levels. If not, repeat steps 9 through 19.

# FLATNESS COMPENSATION ADJUSTMENT

## REFERENCE

A2 Amplifier Assembly and A4 Signal Conditioning Board

## DESCRIPTION

Adjustments A4R67 through R60 (C1 - C8) provide overall flatness compensation across 2 to 20 GHz ensuring calibrated power accuracy. This procedure will characterize the frequency response versus power level displayed on the HP 8349B by manually plotting 11 frequency points across the amplifier's full operating range.

## EQUIPMENT NEEDED

Scalar Network Analyzer	HP 8757A
Sweep Oscillator	HP 8350B
RF Plug-in	HP 83590A
Microwave Amplifier	HP 8349B
DVM	HP 3456A
Power Meter	HP 436A
Programmable Attenuator	HP 8495B
Power Sensor	HP 8485A
10 dB Attenuator	HP 8493C
Detector	HP 11664E

## PROCEDURE

1. Connect the test equipment as shown in Figure 5-13.
2. On the HP 8757A, press **PRESET**.
3. On the HP 8350B, press **SQUARE WAVE MOD** to off.
4. On the HP 83590A, activate the EXT ALC MODE by pressing **EXT**. Press **POWER LEVEL** **0** **dBm**. Adjust the EXT ALC CAL pot for a 0.0 dBm reading on the HP 8349B Power Level Display.



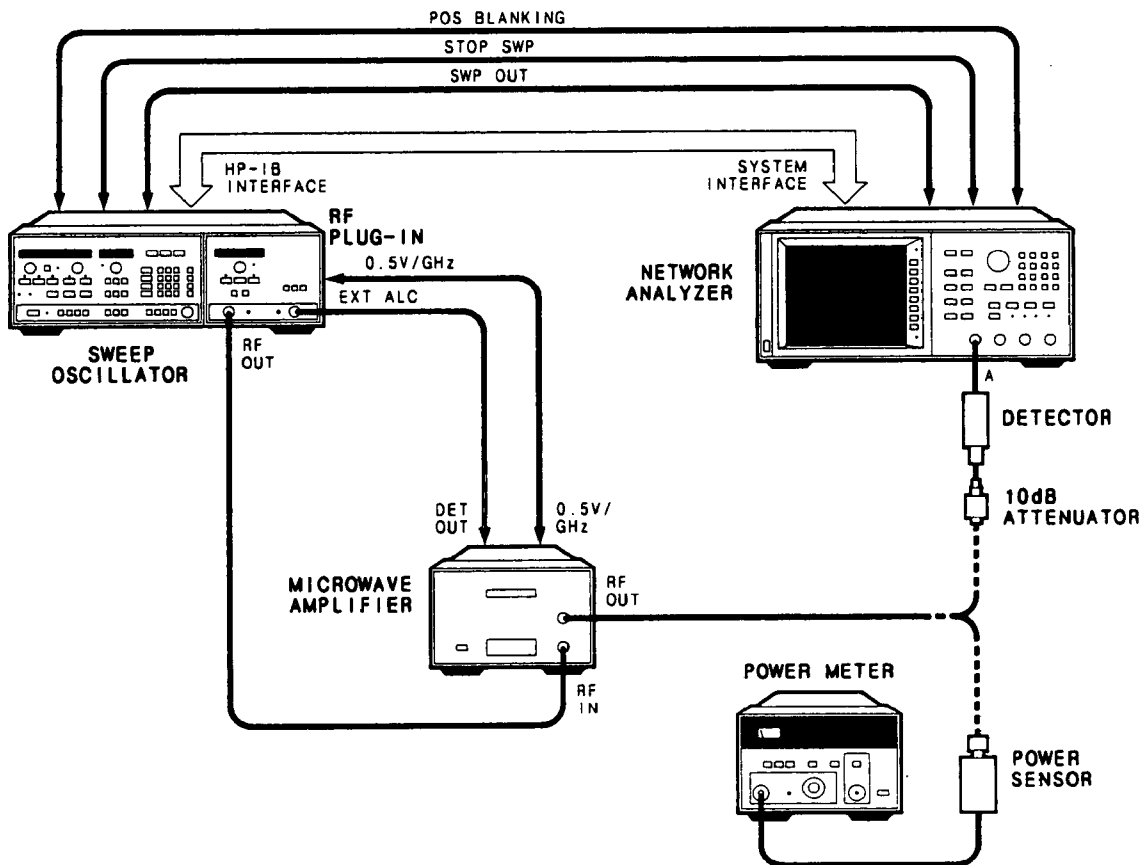

Figure 5-13. Flatness Compensation Equipment Setup

5. With the HP 83590A, an automatic 2 to 20 GHz start/stop frequency is setup at 1.8 GHz/div on the HP 8757A. With plug-ins other than the HP 83590A, ensure that a start frequency of 2 GHz and a stop frequency of 20 GHz is manually keyed in.
6. Ensure in the following steps, the HP 11664E is not connected to the HP 8349B RF output.
7. On the HP 8757A, select **[CHANNEL 2 OFF]**, **[CHANNEL 3 OFF]**, and **[CHANNEL 4 OFF]**. Press **(REF)** then select **[REF POSN]** and center trace with the rotary knob.
8. On the HP 8350B, press **(CW)** **(2)** **(GHz)**. Press **(SQUARE WAVE MOD)** to off.
9. On the HP 436A - before making measurements, ensure that it is properly calibrated. Set CAL FACTOR % for 2 GHz. CAL FACTORS are found on the HP 8485B power sensor.
10. Connect the HP 8485A power sensor to the HP 8349B RF output.
11. On the HP 83590A, press **(POWER LEVEL)** and adjust rotary knob for a 0.00 dBm reading on the HP 436A.
12. Remove the HP 8485A power sensor from the HP 8349B RF output. Connect the HP 11664E detector to the HP 8349B RF output.
13. On the HP 8350B, press **(SQUARE WAVE MOD)** to on.
14. On the HP 8757A, press **(SCALE)** **(1)** **(dB)**. Press **(REF)**, then select **[REF LEVEL]** and center the trace on the center horizontal graticule with rotary knob.

15. The trace displayed represents 2 GHz at 0.00 dBm. This provides the initial frequency point as a reference at the first graticule on the HP 8757A display. See Figure 5-14.
16. Make a copy of Table 5-5 and record the power level (0.00 dBm) into the box under 2 GHz. The remaining power levels that are to be measured will be entered into the HP 8757A to create a 2 through 20 GHz frequency plot.

Table 5-5. Power Levels on HP 8757A

Frequency (GHz)	2.0	3.8	5.6	7.4	9.2	11.0	12.8	14.6	16.4	18.2	20.0
RF Power Level(dBm)											

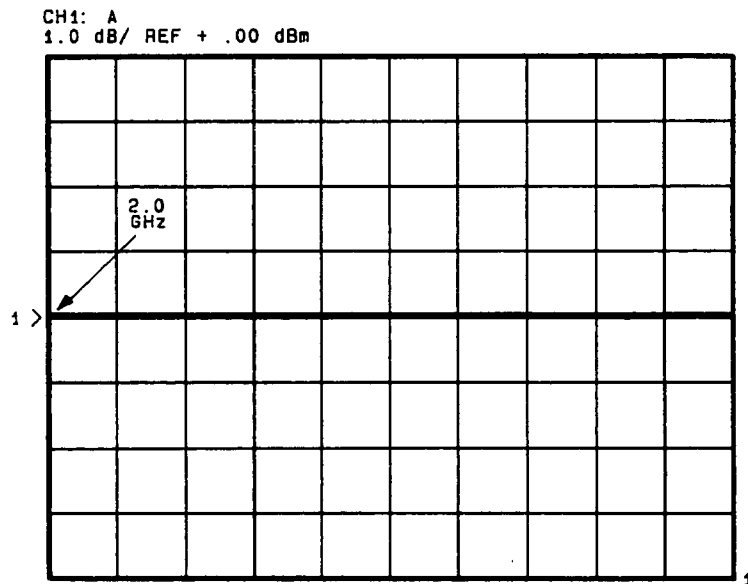

Figure 5-14. 2 GHz Frequency Point

17. On the HP 8350B, press **SQUARE WAVE MOD** to off, then press **CW** **3.8** **GHz**.
18. On the HP 436A, set CAL FACTOR % for 3.8 GHz.
19. Disconnect the HP 11664E detector from the HP 8349B RF output. Connect HP 8485A power sensor to HP 8349B RF output.
20. On the HP 83590A, press **POWER LEVEL** and adjust rotary knob for a 0.00 dBm reading on the HP 436A.
21. Remove the HP 8485A power sensor from the RF output of the HP 8349B. Connect the HP 11664E to the HP 8349B RF output.
22. On the HP 8350B, press **SQUARE WAVE MOD** to on.
23. The trace displayed on the HP 8757A represents 3.8 GHz at 0.00 dBm.

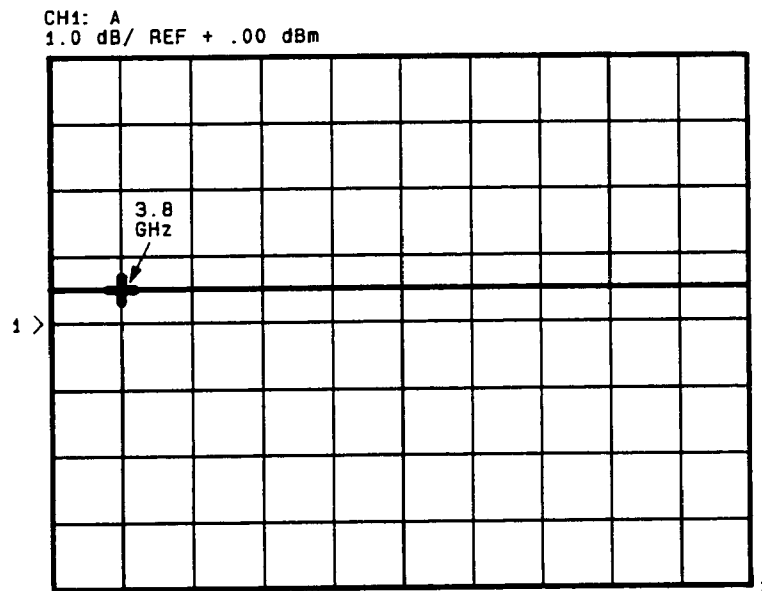

Figure 5-15. 3.8 GHz Frequency Point

24. On the HP 8757A, press **CURSOR**, then rotate the rotary knob to position the cursor display at the second graticule as in Figure 5-15. Note the power level displayed at the top of the CRT and record it in Table 5-5 under the 3.8 GHz box.
25. To complete Table 5-5, repeat steps 17 through 24 for each frequency point.
26. The recorded power levels represent an accurate 2 to 20 GHz response at 0.00 dBm power by measuring true power directly from the RF output of the HP 8349B, thus eliminating any errors that frequency dependent devices introduce into a swept measurement.

### Plotting Measured Data With HP 8757A LIMIT LINES Feature

27. Using sample Table 5-6, the following steps (28 - 48) provide an example of how to enter the measured data (Table 5-5) in the form of LIMIT LINES on the HP 8757A CRT display. The LIMIT LINES feature in the HP 8757A can be used to display data in the form of a plot which characterizes the HP 8349B amplifier at 0 dBm power from 2 to 20 GHz. The measured data (Table 5-5) will be used as a reference for real time frequency compensation adjustments R67 through R60 (C1 - C8).
28. On the HP 8757A, press **SPCL**.
29. Select **[ENTER LIM LNS]**
30. Select **[POINT LIMIT]**

**NOTE:** CRT Prompts follow entries on the HP 8757A. These are special cues to the operator.

Table 5-6. Sample Table

Frequency (GHz)	2.0	3.8	5.6
RF Power Level (dBm)	0.00	0.05	-1.00

31. For CRT prompt - **POINT FREQUENCY?**, enter the first frequency point listed in sample Table 5-6. Press (2), then select [GHz]. The value will be displayed on the CRT.
32. For the following prompt - **POINT UPPER dBm?**, press (0) (dBm). Ignore the **POINT LOWER dBm?** prompt that follows, it will not be needed in this procedure. The value 0.00 is now displayed on the CRT.
33. Press (ENT), to enter the data into the HP 8757A.

The data entered defines the starting point of 2 GHz at 0.00 dBm. This is the reference point at which the frequency plot will begin. The next point that is defined is called a SLOPE POINT. Each slope consists of a start and stop point connected by a slope line. The **SLOPE FREQ #1** prompt, followed by **SLOPE UPPER dBm**, always designates the frequency and power of the starting point of each slope. Always enter the previous frequency and power level end point data at this prompt. This starts the slope where the last point ended.

The **SLOPE FREQ #2** prompt followed by **SLOPE UPPER dBm?**, always designates the end point to a slope. Enter the next frequency point and power level at this prompt. With a 2 to 20 GHz start/stop frequency on the HP 8350B, the starting point (2 GHz) of the POINT FREQUENCY begins at the first graticule on the HP 8757A display.

34. Select [SLOPE LIMIT].
35. For prompt - **SLOPE FREQ #1?**, enter the start point of 2 GHz (this defines where the slope begins). Press (2), then select [GHz].
36. For prompt - **SLOPE UPPER dBm?**, enter 0.00 dBm. Press (0) (dBm). Ignore the **SLOPE LOWER dBm?** prompts that follow, they are not needed in this procedure.
37. Press (ENT), to enter the data into the HP 8757A.

**NOTE:** Both the slope frequency and the slope power are displayed on the CRT.

38. For prompt - **SLOPE FREQ #2?**, enter the next frequency in sample Table 5-6, 3.8 GHz. Press (3) (8) then select [GHz].
39. For prompt - **SLOPE UPPER dBm?**, enter the power level 0.5 dBm. Press (0) (.) (5) (dBm).
40. Press (ENT), to enter the data into the HP 8757A.
41. Select [SLOPE LIMIT] to begin a new slope.
42. For prompt - **SLOPE FREQ #1?**, enter the last frequency point of the previous slope. Press (3) (8) then select [GHz]. This starts the new slope line where the last slope ended.
43. For prompt - **SLOPE UPPER dBm?**, enter the previous power point 0.5 dBm. Press (0) (.) (5) (dBm).
44. Press (ENT) to enter the data.
45. For prompt - **SLOPE FREQ #2?**, enter the next frequency in sample Table 5-6, 5.6 GHz. Press (5) (6) then select [GHz]. This data provides the end frequency point to the second slope.
46. For prompt - **SLOPE UPPER dBm?**, enter the power level -0.5 dBm. Press (-) (0) (.) (5) (dBm). This data provides the end point power level of the second slope.
47. To see the LIMIT LINES on the HP 8757A display, select [DONE] [LIM LNS ON OFF] to turn the LIMIT LINES on (the [ON] will light up.)
48. The LIMIT LINES plot should resemble Figure 5-16.

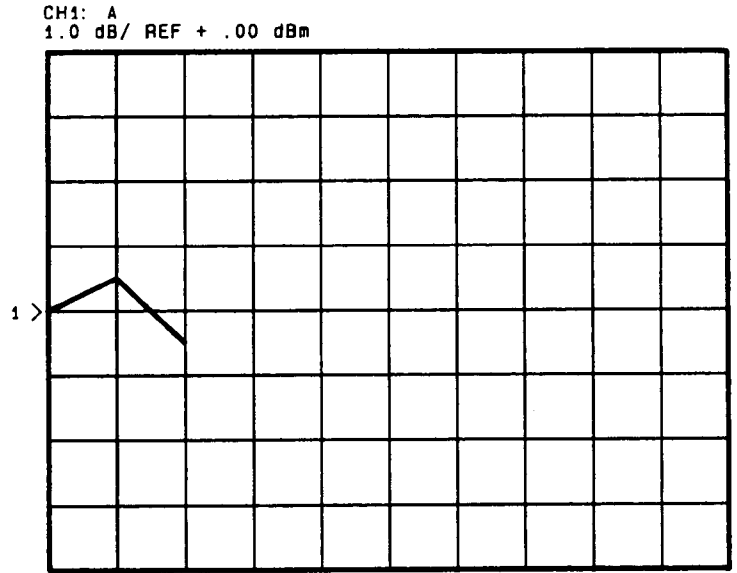

Figure 5-16. Sample Plot

49. To enter the actual measured data from Table 5-5, select **[ENTER LIM LNS]** then select **[DELETE ALL LNS]**. This clears data previously entered into the HP 8757A.
50. Repeat steps 30 through 46 to enter the measured frequency point data recorded in Table 5-5.
51. When you are through entering the data, repeat step 47 to perform the LIMIT LINES plot. The display should resemble Figure 5-17. The actual shape of the plot is determined by the data entered.

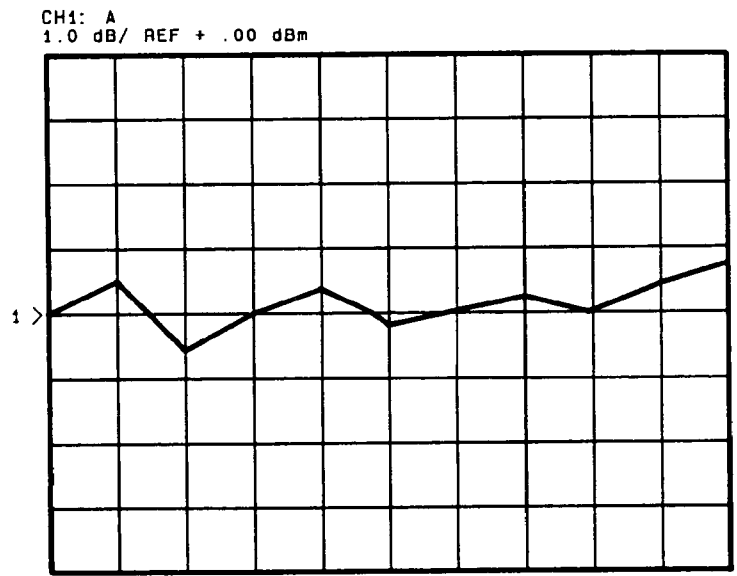

Figure 5-17. Actual LIMIT LINES Plot

52. Store the LIMIT LINES plot into memory, select **[ENTER LIM LNS]**, **[MORE]**, then **[UPR LIM→MEM]**. The prompt - **CHAN 1 UPPER LIMIT TO MEMORY** appears on the CRT.
53. On the HP 8757A, press **(PRESET)**.

54. Select [CHAN 2 OFF], [CHAN 3 OFF], and [CHAN 4 OFF].
55. Press (SCALE) ( ) (5) (dB) .
56. On the HP 8350B, press (SQUARE WAVE MOD) to off.
57. Press (CW) (2) (GHz) .
58. On the HP 83590A, press (POWER LEVEL) .
59. Connect the HP 8485A power sensor to the HP 8349B RF output. Adjust the HP 83590A rotary knob for a 0.00 dBm reading on the HP 436A.
60. Disconnect the HP 8485A power sensor from the HP 8349B RF output. Connect the HP 11664E detector to the HP 8349B RF output.
61. On the HP 8350B: Press (START) (2) (GHz)  
(STOP) (20) (GHz)  
(SQUARE WAVE MOD) to on.

A 2 to 20 GHz swept frequency response of the HP 8349B is displayed on the HP 8757A CRT. See Figure 5-18.

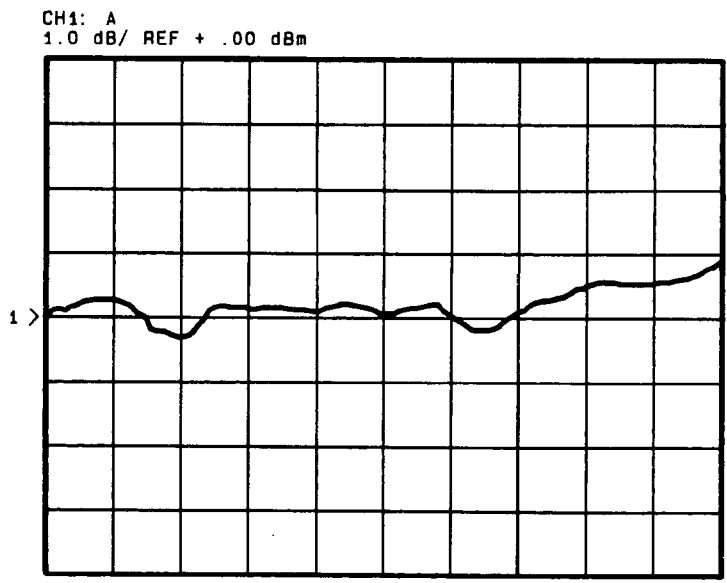

Figure 5-18. 2 to 20 GHz Swept Frequency Response

62. On the HP 8757A, press (DISPLAY) .
63. Select (MEAS-MEM) .
64. The trace now displayed on the HP 8757A is the error between the LIMIT LINES data and the swept response. It should resemble Figure 5-19.

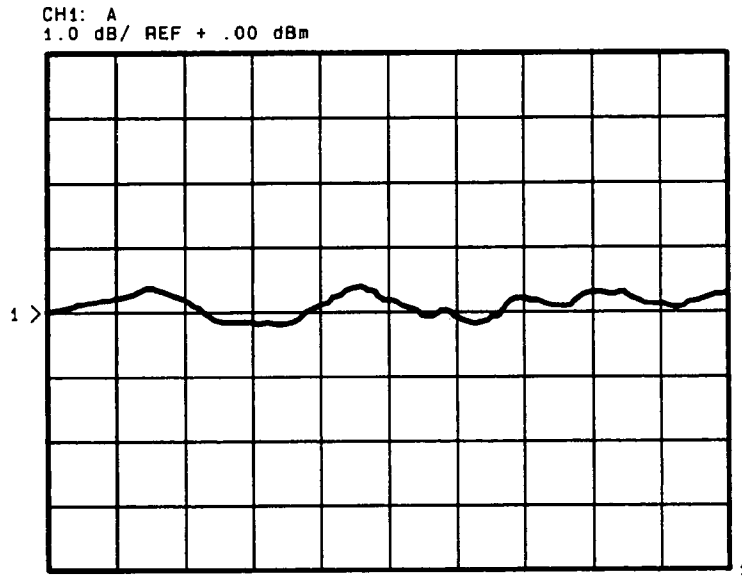

Figure 5-19. MEAS-MEM Trace before Adjustment of R67 - R60 (C1 - C8)

65. Adjust A4R67 through R60 (Flatness Compensation Adjustments C1 - C8) for the flattest possible response relative to the center horizontal graticule across the HP 8757A display. Flatness is typically within 2.5 dB p-p.

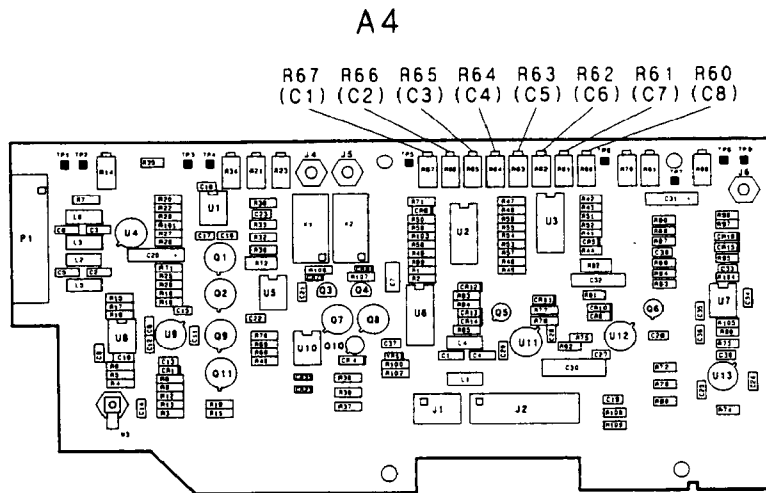

Figure 5-20. Flatness Compensation (R67 - R60) Adjustment Location

66. After you perform the adjustments, the response should resemble Figure 5-21.

**NOTE:** The scale factor on the HP 8757A may be changed to increase display sensitivity when making flatness compensation adjustments.

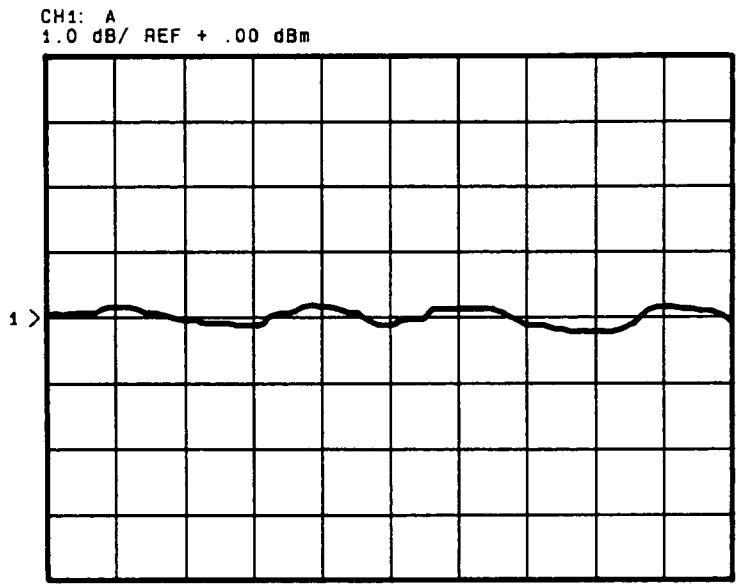

Figure 5-21. Trace after Adjustment

### Power Calibration Adjustment

67. On the HP 8757A, press **SCALE**  **5** **dB**.
68. Press **CURSOR**. Rotate the rotary knob to position the cursor on a portion of the flatness trace that intersects with the center graticule. Ensure that the slope chosen is as smooth and shallow as possible. Note the frequency of the cursor. See Figure 5-22.

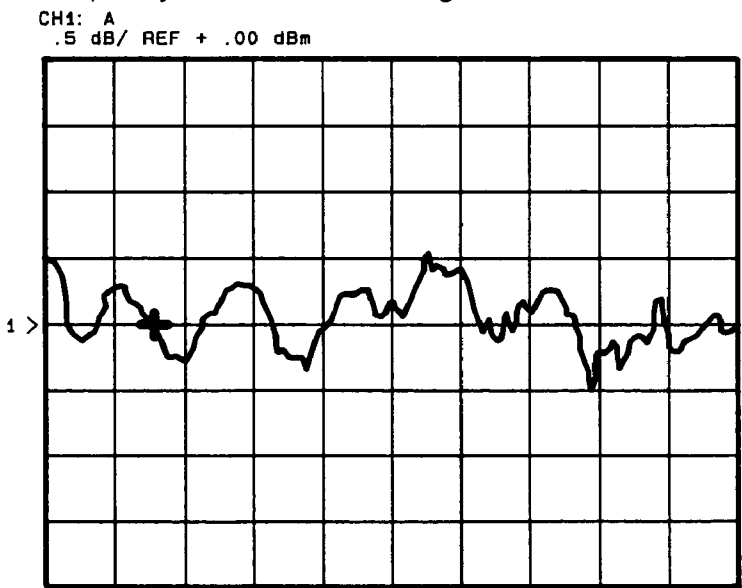

Figure 5-22. Power Cal Adjustment

69. On the HP 83590A, press **CW** and enter the frequency noted in step 68.
70. Press **SQUARE WAVE MOD** to off.
71. Disconnect the HP 11664E detector from the HP 8349B RF output. Connect the HP 8485A power sensor to the HP 8349B RF output.



72. On the HP 436A, set the CAL FACTOR % for the frequency noted in step 68.
73. Adjust A4R21 (0) until the reading on the HP 436A equals the HP 8349B Power Level Display reading.



## Section 6. Replaceable Parts

---

### INTRODUCTION

This section contains information for ordering parts. Table 6-1 lists abbreviations used in the parts list and the names and addresses that correspond to the manufacturer's code numbers. Table 6-2 lists all replaceable parts in reference designator order.

### EXCHANGE ASSEMBLIES

Table 6-2 lists assemblies (A2 Amplifier Assembly) within the instrument that may be replaced on an exchange basis, thus affording a considerable cost savings. Exchange factory repaired and tested assemblies are available only on a trade-in basis, therefore, the defective assemblies must be returned for credit. For this reason, assemblies required for spare parts stock must be ordered by the new assembly part number.

### ABBREVIATIONS

Table 6-1 contains three major sections:

- Reference Designations explain the designators used in the parts list.
- Abbreviations define all abbreviations used in the descriptions of replaceable parts.
- Manufacturer's Code List references the name and address of a typical manufacturer with the code number provided in the parts list.

### REPLACEABLE PARTS LIST

Table 6-2 is the list of replaceable parts and is organized as follows:

- Electrical assemblies and their components in alpha-numerical order by reference designation.
- Chassis-mounted parts in alpha-numerical order by reference designation.
- Cables and connectors in alpha-numerical order.
- Attaching hardware.

The information given for each part consists of the following:

- a. The Hewlett-Packard part number.
- b. The total quantity (Qty) in the instrument.
- c. The description of the part.
- d. A typical manufacturer of the part in a five-digit code.
- e. The manufacturer's number for the part.

The total quantity for each part is given only once — at the first appearance of the part number in the list.

**NOTE:** Total quantities for optional assemblies are totaled by assembly and not integrated into the standard list.

## **ORDERING INFORMATION**

To order a part listed in the Replaceable Parts List, quote the Hewlett-Packard part number, indicate the quantity, and address the order to the nearest Hewlett-Packard office.

To order a part that is not listed in the Replaceable Parts List, include the instrument model number, instrument serial number, description and function of the part, and the number of parts required. Address the order to the nearest Hewlett-Packard office.

## **SPARE PARTS KIT**

Stocking spare parts for an instrument is often done to ensure quick return to service after a malfunction occurs. Hewlett-Packard has a "Spare Parts Kit" available for this purpose. The kit consists of selected replaceable assemblies and components for this instrument. The contents of the kit and the "Recommended Spares" list for this instrument may be obtained on request and the "Spares Parts Kit" may be ordered through your nearest Hewlett-Packard office.

Table 6-1. Reference Designations, Abbreviations, and Manufacturer's Code List (1 of 3)

REFERENCE DESIGNATIONS					
A	Assembly	FL	Filter	S	Switch
AT	Attenuator, Isolator, Limiter, Termination	H	Hardware	T	Transformer
B	Fan, Motor	J	Electrical Connector (Stationary Portion), Jack	TB	Terminal Board
C	Capacitor	K	Relay	TP	Test Point
CP	Coupler	L	Coil, Inductor	U	Integrated Circuit, Microcircuit
CR	Diode, Diode Thyristor, Step Recovery Diode (SCR), Varactor	M	Meter	V	Electron Tube
DC	Directional Coupler	MP	Miscellaneous Mechanical Part	VR	Breakdown Diode (Zener), Voltage Regulator
DS	Annunciator, Lamp, Light Emitting Diode (LED), Signaling Device (Audible or Visible)	P	Electrical Connector (Movable Portion), Plug	W	Cable, Transmission Path, Wire
E	Miscellaneous Electrical Part	Q	Silicon Controlled Rectifier (SCR), Transistor, Triode Thyristor	X	Socket
F	Fuse	R	Resistor	Y	Crystal Unit (Piezoelectric, Quartz)
		RT	Thermistor	Z	Tuned Cavity, Tuned Circuit

ABBREVIATIONS							
<b>A</b>							
A	Across Flats, Acrylic, Air (Dry Method), Ampere	CBL	Cable	<b>E</b>			
ADJ	Adjust, Adjustment	CER	Ceramic	E	Enamel (Insulation, Enhancement, Extension)		
AL	Aluminum	CH	Center Hole	E-MODE	Enhancement Mode		
ALC	Alcohol, Automatic Level Control	CHAM	Chamfer	EPROM	Eraseable Programmable Read Only Memory		
AMP	Amperage	CHAN	Channel	EXCL	Excluding, Exclusive		
AMPL	Amplifier	COAX	Coaxial	EXT	Extended, Extension, External, Extinguish		
ANDZ	Anodized	COM	Commercial, Common	<b>F</b>			
ANLG	Analog	CONN	Connect, Connection, Connector	F	Fahrenheit, Farad, Female, Film, (Resistor), Fixed, Flange, Flint, Flourine, Frequency		
ASSY	Assembly	CONT	Contact, Continuous, Control, Controller	FDTHRU	Feed Through		
ASTBL	Astable	CONV	Converter	FEM	Female		
ATTEN	Attenuation, Attenuator	CP	Cadmium Plate, Candle Power, Centipoise, Conductive Plastic, Cone Point	FF	Flange, Female Connection; Flip Flop		
AWG	American Wire Gauge	CRP	Crepe, Crimp	FL	Flash, Flat, Fluid		
<b>B</b>			CTR	Center	FLX	Flexible	
BCKT	Bracket	CURRNT	Current	FLG	Flange	FLTR	Filter, Floater
BD	Board, Bundle	<b>D</b>			FT	Current Gain Bandwidth	
BE	Baume, Beryllium	D	Deep, Depletion, Depth, Diameter, Direct Current	FM	Flange, Male Connection; Foam, Frequency Modulation Product (Transition Frequency); Feet, Foot		
BFR	Before, Buffer	D/A	Digital-to-Analog	FXD	Fixed		
BLK	Black, Blank, Block	DAP	Diallyl Phthalate	<b>G</b>			
BNC	Type of Connector	DB	Decibel, Double Break	GEN	General, Generator		
BSC	Basic	DC	Direct Current, Double Contact	GHZ	Gigahertz		
BVR	Reverse, Breakdown Voltage	DBL	Double	GP	General Purpose Group		
<b>C</b>			DCDR	Decoder	GL	Glass	
C	Capacitance, Capacitor, Center Tapped, Centistoke, Ceramic, Cermet, Circular Mil Foot, Closed Cup, Cold, Compression	DEG	Degree	GRN	Green		
		DIA	Diameter	GRV	Grooved		
		DIFF	Differential				
		DIP	Dual In-Line Package				
		DO	Package Type Designation				
		DRVR	Driver				

Table 6-1. Reference Designations, Abbreviations, and Manufacturer's Code List (2 of 3)

<b>H</b>		
H	Henry, Hermaphrodite, High, Hole Diameter, Hot, Hub Inside Diameter, Hydrogen	
HD	Hand, Hard, Head, Heavy Duty	
HEX	Hexadecimal, Hexagon, Hexagonal	
HGT	Height	
<b>I</b>		
IC	Collector Current, Integrated Circuit	
ID	Identification, Inside Diameter	
IF	Forward Current, Intermediate Frequency	
IMPD	Impedance	
IN	Inch, Indium	
INP	Input	
INS	Insert, Inside, Insulation, Insulator	
INT	Integral, Intensity, Internal	
INTL	Internal, International	
INV	Invert, Inverter	
<b>J</b>		
JFET	Effect Transistor	
<b>K</b>		
K	Kelvin, Key, Kilo, Potassium	
KB	Knob	
<b>L</b>		
LED	Light Emitting Diode	
LG	Length, Long	
LIN	Linear, Linear Taper, Linearity	
LK	Link, Lock	
LKG	Leakage, Locking	
LKWR	Lockwasher	
LS	Loudspeaker, Low Power Schottky, Series Inductance	
LUM	Luminous	
<b>M</b>		
M	Male, Maximum, Mega, Mil, Milli, Mode, Momentary, Mounting Hole Centers, Mounting Hole Diameter	
MA	Milliampere	
MACH	Machined	
MAX	Maximum	
MCD	Millacandela	
MICPROC	Microprocessor	
MIN	Miniature, Minimum, Minor, Minute	
MLD	Mold, Molded	
MM	Magnetized Material (Restricted Articles Code), Millimeter	
MO	Metal Oxide, Millionce, Molybdenum	
MOD	Model, Modified Modular, Modulated, Modulator	
MOM	Momentary, Motherboard	
MTG	Mounting	
MTLC	Metallic	
MTR	Meter	
MULTIPLXR	Multiplexer	
MULTR	Multiplier	
MUW	Music Wire	
MW	Milliwatt	
<b>N</b>		
N-CHAN	N-Channel Metal Oxide Semiconductor	
NB	Niobium	
NCH	Notched	
NEG	Negative	
NH	Nanohenry	
NM	Nanometer, Nonmetallic	
NO	Normally Open, Number	
NPN	Negative Positive Negative (Transistor)	
NS	Nanosecond, Non-Shorting, Nose	
NYL	Nylon (Polyamide)	
<b>O</b>		
OCTL	Octal	
OD	Olive Drab, Outside Diameter	
OP	Operational	
OPT	Optical, Option, Optional	
OXD	Oxide	
<b>P</b>		
PAN-HD	Pan Head	
PC	Picocoulomb, Piece, Printed Circuit	
P.C.	Printed Circuit	
PCB	Printed Circuit Board	
PD	Pad, Palladium, Pitch Diameter, Power Dissipation	
PF	Picofarad; Pipe, Female Connection; Power Factor	
PKG	Package	
PL	Phase Lock, Plain, Plate, Plug	
PL-MTG	Plate Mounting	
PLSTC	Plastic	
PN	Part Number	
PNP	Positive Negative Positive (Transistor)	
POLYC	Polycarbonate	
POLYE	Polyester	
POLYI	Polyimide	
POS	Position, Positive	
POZI	Pozidrive Recess	
PRCN	Precision	
PRIM	Primary	
PRL	Parallel	
PRP	Purple, Purpose	
P/S	Power Supply	
PT	Part, Pint, Platinum, Point, Pulse Time	
PVC	Polyvinyl Chloride	
PW	Power Wirewound, Pulse Width	
<b>Q</b>		
QUAD	Set of Four	
<b>R</b>		
RBN	Ribbon	
RCVR	Receiver	
RECT	Rectangle, Rectangular, Rectifier	
RES	Research, Resistance, Resistor, Resolution	
RET	Retaining	
RF	Radio Frequency	
RFI	Radio Frequency Interference	
RFLTR	Regulator	
RKR	Rocker	
RND	Round	
RPG	Rotary Pulse Generator	
RR	Rear	
RVT	Rivet, Riveted	
<b>S</b>		
SCR	Screw, Scrub, Silicon Controlled Rectifier	
SEC	Secondary	
SER	Serial, Series	
SGL	Single	
SHFT	Shaft	
SHLDR	Shoulder	
SI	Silicon, Square Inch	
SIG	Signal, Significant	
SIP	Single In-Line Package	
SKT	Skirt, Socket	
SLDR	Solder	
SM	Samarium, Seam, Small, Square Meter, Sub Modular, Subminiature	
SMB	Subminiature, B Type (Snap-On Connector)	

Table 6-1. Reference Designations, Abbreviations, and Manufacturer's Code List (3 of 3)

SNP	..... Snap	TO	..... Package Type			<b>W</b>	
SPCL	..... Special	TPL	..... Triple	W	..... Watt, Wattage, White,		
SQ	..... Square	TRIG	..... Trigger, Triggerable,	WB	..... Wide Band		
SST	..... Stainless Steel		..... Triggering, Trigonometry		..... Wide, Width, Wire		
STDF	..... Standoff	TRMR	..... Trimmer	WD	..... Width, Wood		
SZ	..... Size	TRN	..... Turn, Turns				
	<b>T</b>	TTL	..... Tan Translucent,			<b>X</b>	
T	..... Tab Width, Taper, Teeth,		..... Transistor, Transistor Logic	XSTR	..... Transistor		
	..... Temperature, Tera, Tesla,					<b>Y</b>	
	..... Thermoplastic (Insulation),	UCD	..... Microcandela				
	..... Thickness, Time, Timed, Tooth,	UNCT	..... Undercut				
	..... Turns Ratio, Typical	UF	..... Microfarad	YIG	..... Yttrium-iron-garnet		
TA	..... Ambient Temperature,			YTM	..... YIG Tuned Multiplier		
	..... Tantalum		<b>V</b>				
TC	..... Thermoplastic	V	..... Vanadium, Variable,			<b>Z</b>	
TFE	..... Polytetrafluoro - ethylene,		..... Violet, Volt, Voltage				
	..... Teflon	VA	..... Volt Ampere				
THD	..... Thread, Threaded	VDC	..... Volts, Direct Current	ZN-P	..... Zinc Plate		
THK	..... Thick	VID	..... Video	ZNR	..... Zener		

<b>MANUFACTURER'S CODE LIST</b>			
<b>Mfr Code</b>	<b>Manufacturer Name</b>	<b>Address</b>	<b>Zip Code</b>
00493	United Chemi-Con Inc	Compton	CA 90220
01380	AMP Inc	Harrisburg	PA 17111
01607	Allen-Bradley Co Inc	El Paso	TX 79935
01698	Texas Instruments Inc	Dallas	TX 75265
01850	Aromat Corp	Mountainside	NJ 07092
02010	AVX Corp	Great Neck	NY 11021
02037	Motorola Inc	Roselle	IL 60195
02121	Lyn-Tron Inc	Burbank	CA 91505
02180	Precision Monolithics Inc	Santa Clara	CA 95054
02210	Milton Ross Co	Southampton	PA 18966
02483	CTS Corp	Elkhart	IN 46514
02499	IRC Inc	Boone	NC 28607
02664	Semtech Corp	Newbury Park	CA 91320
02805	Cooper Industries Inc	Houston	TX 77210
02883	Siliconix Inc	Santa Clara	CA 95054
02946	DuPont E I De Nemours & Co	Wilmington	DE 19801
02995	North American Philips Corp	New York	NY 10017
03038	International Rectifier Corp	Los Angeles	CA 90069
03273	Gowanda Electronics Corp	Gowanda	NY 14070
03285	Analog Devices Inc	Norwood	MA 02062
03334	NV Philips Elcoma	Eindhoven	02876
03406	National Semiconductor Corp	Santa Clara	CA 95052
03418	Molex Inc	Lisle	IL 60532
03799	Harris Corp	Melbourne	FL 32901
03981	Penn Engineering & Mfg Corp	Doylestown	PA 18901
04055	Overland Products Co	Phoenix	AZ 68025
04129	Aries Electronics Inc	Frenchtown	NJ 08825
04200	Sprague Electric Co	Lexington	MA 02173
04504	General Instrument Corp	Clifton	NJ 07012
04568	Beckman Industrial Corp	Fullerton	CA 92635
05176	American Shizuki Corp	Canoga Park	CA 91304
05524	Dale Electronics Inc	Columbus	NE 68601
05769	ITT Sealectro Corp	Trumbull	CT 06611
05792	International Electronic Research Corp	Burbank	CA 91502
05826	Amer Prcn Ind Inc Delevan Div	Aurora	NY 14052
06784	Midwest Components	Muskegon	MI 49443
09939	Murata Erie North America Inc	Smyrna	GA 30080
13127	Linear Integrated Systems Inc	Fremont	CA 94539
28480	Hewlett-Packard Co Corporate HQ	Palo Alto	CA 94304

Table 6-2. Replaceable Parts

Ref Desig	HP Part Number	Qty	Description	Mfr Code	Mfr Part Number
A1	08349-60036	1	DISPLAY BOARD ASSEMBLY	28480	08349-60036
C1	0160-4084	1	CAP-FXD 0.1uF ± 20% 50 V CER X7R	02010	SR215C104MAAH
C2	0160-4084	1	CAP-FXD 0.1uF ± 20% 50 V CER X7R	02010	SR215C104MAAH
C3	0160-4084	1	CAP-FXD 0.1uF ± 20% 50 V CER X7R	02010	SR215C104MAAH
C4	0160-4653	1	CAP-FXD 0.1uF ± 5% 100 V POLYP-MET	05176	HEW-505
C5	0180-0197	1	CAP-FXD 2.2uF ± 10% 20 V TA	04200	150D225X9020A2-OYS
C6	0180-2207	1	CAP-FXD 100uF ± 10% 10 V TA	04200	150D107X9010R2-DYS
C7	0180-0197	1	CAP-FXD 2.2uF ± 10% 20 V TA	04200	150D225X9020A2-DYS
C8	0160-3879	1	CAP-FXD 0.01uF ± 20% 100 V CER X7R	02010	SR201C103MAAH
C9	0160-3879	1	CAP-FXD 0.01uF ± 20% 100 V CER X7R	02010	SR201C103MAAH
CR4	1901-0050	1	DIODE-SWITCHING 80V 200MA 2NS DO-35	03334	BAV10 SELECTED
DS1	1990-0619	1	DISPLAY-NUM-SEG 1-CHAR .3-H	01542	5082-7613
DS2	1990-0619	1	DISPLAY-NUM-SEG 1-CHAR .3-H	01542	5082-7613
DS3	1990-0619	1	DISPLAY-NUM-SEG 1-CHAR .3-H	01542	5082-7613
DS4	1990-0619	1	DISPLAY-NUM-SEG 1-CHAR .3-H	01542	5082-7613
L1	9100-1644	1	INDUCTOR RF-CH-MLD 330UH ± 5%	05826	2500-04
MP2	1200-0172	4	INSULATOR-XSTR DAP-GL	02210	10042-DAP
Q1	1853-0007	1	TRANSISTOR PNP 2N3251 SI TO-18 PD = 360MW	02037	2N3251
Q2	1855-0386	1	TRANSISTOR J-FET 2N4392 N-CHAN D-MODE	02037	2N4392
Q3	1855-0386	1	TRANSISTOR J-FET 2N4392 N-CHAN D-MODE	02037	2N4392
Q4	1855-0386	1	TRANSISTOR J-FET 2N4392 N-CHAN D-MODE	02037	2N4392
R1	0698-7277	1	RESISTOR 51.1K ± 1% .05W TF TC = 0 ± 100	02995	5023R
R2	0698-7244	1	RESISTOR 2.15K ± 1% .05W TF TC = 0 ± 100	02995	5063J
R3	0698-7221	1	RESISTOR 237 ± 1% .05W TF TC = 0 ± 100	02995	5063J
R5	0698-6348	1	RESISTOR 3K ± 0.1% .125W TF TC = 0 ± 25	02995	5033R
R6	0698-6362	1	RESISTOR 1K ± 0.1% .125W TF TC = 0 ± 25	02995	5033R
R7	0698-3260	1	RESISTOR 464K ± 1% .125W TF TC = 0 ± 100	02995	SFR25H
R8	0698-3457	1	RESISTOR 316K ± 1% .125W TF TC = 0 ± 100	02995	SFR25H
R10	0698-7229	1	RESISTOR 511 ± 1% .05W TF TC = 0 ± 100	02995	5063J
R11	0698-7260	1	RESISTOR 10K ± 1% .05W TF TC = 0 ± 100	02995	5063J
R12	0698-7260	1	RESISTOR 10K ± 1% .05W TF TC = 0 ± 100	02995	5063J
R13	0698-7260	1	RESISTOR 10K ± 1% .05W TF TC = 0 ± 100	02995	5063J
R14	0698-7277	1	RESISTOR 51.1K ± 1% .05W TF TC = 0 ± 100	02995	5023R
R15	0698-3444	1	RESISTOR 316 ± 1% .125W TF TC = 0 ± 100	02995	SFR25H
R17	0757-0438	1	RESISTOR 5.11K ± 1% .125W TF TC = 0 ± 100	02995	SFR25H
R18	0757-0438	1	RESISTOR 5.11K ± 1% .125W TF TC = 0 ± 100	02995	SFR25H
R19	0698-3160	1	RESISTOR 31.6K ± 1% .125W TF TC = 0 ± 100	02995	SFR25H
R20	0698-8827	1	RESISTOR 1M ± 1% .125W TF TC = 0 ± 100	02995	SFR25H
R21	0698-0084	1	RESISTOR 2.15K ± 1% .125W TF TC = 0 ± 100	02995	SFR25H
R22	0757-0438	1	RESISTOR 5.11K ± 1% .125W TF TC = 0 ± 100	02995	SFR25H
R23	0698-7260	1	RESISTOR 10K ± 1% .05W TF TC = 0 ± 100	02995	5063J
R24	0698-7284	1	RESISTOR 100K ± 1% .05W TF TC = 0 ± 100	02995	5023R
R25	0698-7284	1	RESISTOR 100K ± 1% .05W TF TC = 0 ± 100	02995	5023R
R26	0698-7284	1	RESISTOR 100K ± 1% .05W TF TC = 0 ± 100	02995	5023R
TP1	0360-2050	1	CONNECTOR-SGL CONT	04055	
TP2	0360-2050	1	CONNECTOR-SGL CONT	04055	
TP3	0360-2050	1	CONNECTOR-SGL CONT	04055	
U1	1826-0431	1	A/D 3-1/2-DGT 24-CERDIP CMOS	02037	MC14433L
U2	1858-0047	1	TRANSISTOR ARRAY 16-PIN PLSTC DIP	04200	ULN-2003A
U3	1820-1413	1	IC DCDR CMOS BCD-TO-7-SEG 4-TO-7-LINE	02037	MC14511BCP
U4	1810-0346	1	NETWORK-RES 16-DIP 180.0 OHM X 8	02483	761-3-R180
U5	1826-0138	1	IC COMPARATOR GP QUAD 14-DIP-P PKG	03406	LM339N
VR1	1902-0554	1	DIODE-ZNR 10V 5% PD = 1W IR = 10UA	02037	
X1	1200-0693	4	SOCKET-IC-DIP 10-CONT DIP DIP-SLDR	04129	10-513-11



Table 6-2. Replaceable Parts

Ref Desig	HP Part Number	Qty	Description	Mfr Code	Mfr Part Number
A2	08349-60062	1	2 TO 20 GHZ AMPLIFIER REPLACEMENT KIT (INCLUDES BIAS BD ASSY A3, RF INPUT & OUTPUT CABLE W4 & W5, CONNECTORS J1 & J2, HEAT SINK, TRANSISTOR BLOCK AND CONNECTING HARDWARE)	28480	08349-60062
A2	08349-60065		REBUILT-EXCHANGE AMPLIFIER KIT 2 TO 20 GHZ AMPLIFIER ASSEMBLY	28480	08349-60065
A2	08349-60063		OPTION 001 AMPLIFIER ASSEMBLY REPLACEMENT KIT (REAR PANEL RF INPUT AND OUTPUT)	28480	08349-60063
A2	08349-60066		REBUILT-EXCHANGE OPTION 001 AMPLIFIER KIT	28480	08349-60066
A2	08349-60064		OPTION 002 AMPLIFIER ASSEMBLY REPLACEMENT KIT (REAR PANEL RF INPUT)	28480	08349-60064
A2	08349-60067		REBUILT-EXCHANGE OPTION 002 AMPLIFIER KIT	28480	08349-60067

Table 6-2. Replaceable Parts

Ref Desig	HP Part Number	Qty	Description	Mfr Code	Mfr Part Number
A3	08349-60038	1	BOARD ASSY-BIAS	26480	08349-60038
C1	0160-4832	1	CAP-FXD 0.01uF ± 10% 100 V CER X7R	02010	SA101C103KAAH
C2	0160-4832	1	CAP-FXD 0.01uF ± 10% 100 V CER X7R	02010	SA101C103KAAH
C3	0160-4832	1	CAP-FXD 0.01uF ± 10% 100 V CER X7R	02010	SA101C103KAAH
C4	0160-4832	1	CAP-FXD 0.01uF ± 10% 100 V CER X7R	02010	SA101C103KAAH
C5	0160-4832	1	CAP-FXD 0.01uF ± 10% 100 V CER X7R	02010	SA101C103KAAH
C6	0160-4832	1	CAP-FXD 0.01uF ± 10% 100 V CER X7R	02010	SA101C103KAAH
C7	0160-4832	1	CAP-FXD 0.01uF ± 10% 100 V CER X7R	02010	SA101C103KAAH
C8	0160-4832	1	CAP-FXD 0.01uF ± 10% 100 V CER X7R	02010	SA101C103KAAH
C9	0160-4832	1	CAP-FXD 0.01uF ± 10% 100 V CER X7R	02010	SA101C103KAAH
C10	0160-4832	1	CAP-FXD 0.01uF ± 10% 100 V CER X7R	02010	SA101C103KAAH
C11	0160-4832	1	CAP-FXD 0.01uF ± 10% 100 V CER X7R	02010	SA101C103KAAH
C12	0160-4832	1	CAP-FXD 0.01uF ± 10% 100 V CER X7R	02010	SA101C103KAAH
J1	1251-5267	1	CONN-POST TYPE .100-PIN-SPCG 40-CONT	02946	68020-640
MP3	0380-1245	4	SPACER-RVT-ON 4-MM-LG 3.8-MM-ID	02121	
MP4	1200-0173	2	INSULATOR-XSTR DAP-GL	02210	A-10001 DAP
MP6	0380-1246	4	SPACER-RVT-ON 6-MM-LG 3.8-MM-ID	02121	
P1	1251-8603	1	CONN-POST TYPE .100-PIN-SPCG 24-CONT	01380	1-534204-1
P2	1251-8603	1	CONN-POST TYPE .100-PIN-SPCG 24-CONT	01380	1-534204-1
Q1	1854-0637	1	TRANSISTOR NPN 2N2219A SI TO-5 PD=800MW	02037	2N2219A
Q2	1854-0637	1	TRANSISTOR NPN 2N2219A SI TO-5 PD=800MW	02037	2N2219A
R1	0698-3446	1	RESISTOR 383 ± 1% .125W TF TC=0 ± 100	02995	SFR25H
R2	0757-0418	1	RESISTOR 619 ± 1% .125W TF TC=0 ± 100	02995	SFR25H
R3	0698-3446	1	RESISTOR 383 ± 1% .125W TF TC=0 ± 100	02995	SFR25H
R4	0757-0418	1	RESISTOR 619 ± 1% .125W TF TC=0 ± 100	02995	SFR25H
R5	0757-0398	1	RESISTOR 75 ± 1% .125W TF TC=0 ± 100	02995	SFR25H
R6	0698-3433	1	RESISTOR 28.7 ± 1% .125W TF TC=0 ± 100	02995	SFR25H
R7	0757-0398	1	RESISTOR 75 ± 1% .125W TF TC=0 ± 100	02995	SFR25H
R8	0698-3433	1	RESISTOR 28.7 ± 1% .125W TF TC=0 ± 100	02995	SFR25H
R9	0698-4037	1	RESISTOR 46.4 ± 1% .125W TF TC=0 ± 100	02995	SFR25H
R10	0757-0394	1	RESISTOR 51.1 ± 1% .125W TF TC=0 ± 100	02995	SFR25H
R11	0698-4037	1	RESISTOR 46.4 ± 1% .125W TF TC=0 ± 100	02995	SFR25H
R12	0757-0394	1	RESISTOR 51.1 ± 1% .125W TF TC=0 ± 100	02995	SFR25H
R13	0757-0438	1	RESISTOR 5.11K ± 1% .125W TF TC=0 ± 100	02995	SFR25H
R14	0757-0438	1	RESISTOR 5.11K ± 1% .125W TF TC=0 ± 100	02995	SFR25H
R15	0757-0438	1	RESISTOR 5.11K ± 1% .125W TF TC=0 ± 100	02995	SFR25H
R16	0757-0438	1	RESISTOR 5.11K ± 1% .125W TF TC=0 ± 100	02995	SFR25H
R17	0757-0438	1	RESISTOR 5.11K ± 1% .125W TF TC=0 ± 100	02995	SFR25H
R18	0757-0438	1	RESISTOR 5.11K ± 1% .125W TF TC=0 ± 100	02995	SFR25H
R21	0757-0288	1	RESISTOR 9.09K ± 1% .125W TF TC=0 ± 100	02995	SFR25H
R22	0757-0288	1	RESISTOR 9.09K ± 1% .125W TF TC=0 ± 100	02995	SFR25H
R23	0757-0288	1	RESISTOR 9.09K ± 1% .125W TF TC=0 ± 100	02995	SFR25H
R24	0757-0288	1	RESISTOR 9.09K ± 1% .125W TF TC=0 ± 100	02995	SFR25H
R25	0698-8812	1	RESISTOR 1 ± 1% .125W TF TC=0 ± 100	05524	CMF-55-1
R26	0698-8812	1	RESISTOR 1 ± 1% .125W TF TC=0 ± 100	05524	CMF-55-1
R27	0698-8812	1	RESISTOR 1 ± 1% .125W TF TC=0 ± 100	05524	CMF-55-1
R28	0698-8812	1	RESISTOR 1 ± 1% .125W TF TC=0 ± 100	05524	CMF-55-1
R29	0698-3547	1	RESISTOR 1 ± 5% .5W CC TC=0+412	01607	EB10G5
R30	0698-3547	1	RESISTOR 1 ± 5% .5W CC TC=0+412	01607	EB10G5
R33	0757-0288	1	RESISTOR 9.09K ± 1% .125W TF TC=0 ± 100	02995	SFR25H
R34	0757-0288	1	RESISTOR 9.09K ± 1% .125W TF TC=0 ± 100	02995	SFR25H
R37	0698-3392	1	RESISTOR 23.7 ± 1% .5W TF TC=0 ± 100	02995	5053R
R38	0698-3392	1	RESISTOR 23.7 ± 1% .5W TF TC=0 ± 100	02995	5053R
R40	2100-3094	1	RESISTOR-TRMR 100K 10% TKF SIDE-ADJ	04568	89PR100K
R41	2100-3094	1	RESISTOR-TRMR 100K 10% TKF SIDE-ADJ	04568	89PR100K
R42	2100-3094	1	RESISTOR-TRMR 100K 10% TKF SIDE-ADJ	04568	89PR100K
R43	2100-3094	1	RESISTOR-TRMR 100K 10% TKF SIDE-ADJ	04568	89PR100K
U1	1810-0316	1	NETWORK-RES 16-DIP 10.0K OHM X 8	02483	761-3-R10K
U2	1810-0316	1	NETWORK-RES 16-DIP 10.0K OHM X 8	02483	761-3-R10K
U3	1810-0316	1	NETWORK-RES 16-DIP 10.0K OHM X 8	02483	761-3-R10K
X1	1251-3172	23	CONNECTOR-SGL CONT SKT .03-IN-BSC-SZ RND	01380	2-331677-9
X2	1251-2313	4	CONNECTOR-SGL CONT SKT .04-IN-BSC-SZ RND	01380	3-332070-5

Table 6-2. Replaceable Parts

Ref Desig	HP Part Number	Qty	Description	Mfr Code	Mfr Part Number
A4	08349-60079	1	BD AY-SIG COND T	28480	08349-60079
C1	0160-4535	1	CAP-FXD 1uF ± 10% 50 V CER X7R	09939	RPE113-130X7R105K50V
C2	0160-4535	1	CAP-FXD 1uF ± 10% 50 V CER X7R	09939	RPE113-130X7R105K50V
C3	0160-4535	1	CAP-FXD 1uF ± 10% 50 V CER X7R	09939	RPE113-130X7R105K50V
C4	0160-4535	1	CAP-FXD 1uF ± 10% 50 V CER X7R	09939	RPE113-130X7R105K50V
C5	0160-4535	1	CAP-FXD 1uF ± 10% 50 V CER X7R	09939	RPE113-130X7R105K50V
C6	0160-4535	1	CAP-FXD 1uF ± 10% 50 V CER X7R	09939	RPE113-130X7R105K50V
C7	0160-4535	1	CAP-FXD 1uF ± 10% 50 V CER X7R	09939	RPE113-130X7R105K50V
C8	0160-0575	1	CAP-FXD 0.047uF ± 20% 50 V CER X7R	02010	SR205C473MAAH
C9	0160-0575	1	CAP-FXD 0.047uF ± 20% 50 V CER X7R	02010	SR205C473MAAH
C10	0160-4799	1	CAP-FXD 2.2pF ± 11.36% 100 V CER COG	02010	MA101A2R2CAAH
C11	0160-0575	1	CAP-FXD 0.047uF ± 20% 50 V CER X7R	02010	SR205C473MAAH
C12	0160-0575	1	CAP-FXD 0.047uF ± 20% 50 V CER X7R	02010	SR205C473MAAH
C13	0160-4791	1	CAP-FXD 10pF ± 5% 100 V CER COG	02010	SA102A100JAAH
C14	0160-0575	1	CAP-FXD 0.047uF ± 20% 50 V CER X7R	02010	SR205C473MAAH
C15	0160-0575	1	CAP-FXD 0.047uF ± 20% 50 V CER X7R	02010	SR205C473MAAH
C16	0160-0575	1	CAP-FXD 0.047uF ± 20% 50 V CER X7R	02010	SR205C473MAAH
C17	0160-0575	1	CAP-FXD 0.047uF ± 20% 50 V CER X7R	02010	SR205C473MAAH
C18	0160-0575	1	CAP-FXD 0.047uF ± 20% 50 V CER X7R	02010	SR205C473MAAH
C19	0160-4822	1	CAP-FXD 1000pF ± 5% 100 V CER COG	02010	SA201A102JAAH
C20	0180-0116	1	CAP-FXD 6.8uF ± 10% 35 V TA	04200	150D685X9035B2-DYS
C21	0160-0575	1	CAP-FXD 0.047uF ± 20% 50 V CER X7R	02010	SR205C473MAAH
C22	0160-0575	1	CAP-FXD 0.047uF ± 20% 50 V CER X7R	02010	SR205C473MAAH
C23	0160-4799	1	CAP-FXD 2.2pF ± 11.36% 100 V CER COG	02010	MA101A2R2CAAH
C24	0160-0575	1	CAP-FXD 0.047uF ± 20% 50 V CER X7R	02010	SR205C473MAAH
C25	0160-0575	1	CAP-FXD 0.047uF ± 20% 50 V CER X7R	02010	SR205C473MAAH
C26	0160-0575	1	CAP-FXD 0.047uF ± 20% 50 V CER X7R	02010	SR205C473MAAH
C27	0160-0575	1	CAP-FXD 0.047uF ± 20% 50 V CER X7R	02010	SR205C473MAAH
C28	0160-0575	1	CAP-FXD 0.047uF ± 20% 50 V CER X7R	02010	SR205C473MAAH
C29	0160-0575	1	CAP-FXD 0.047uF ± 20% 50 V CER X7R	02010	SR205C473MAAH
C30	0160-4653	1	CAP-FXD 0.1uF ± 5% 100 V POLYP-MET	05176	HEW-505
C31	0180-0116	1	CAP-FXD 6.8uF ± 10% 35 V TA	04200	150D685X9035B2-DYS
C32	0180-0116	1	CAP-FXD 6.8uF ± 10% 35 V TA	04200	150D685X9035B2-DYS
C33	0160-4805	1	CAP-FXD 47pF ± 5% 100 V CER COG	02010	SA102A470JAAH
C34	0160-0575	1	CAP-FXD 0.047uF ± 20% 50 V CER X7R	02010	SR205C473MAAH
C35	0160-0575	1	CAP-FXD 0.047uF ± 20% 50 V CER X7R	02010	SR205C473MAAH
C36	0160-0575	1	CAP-FXD 0.047uF ± 20% 50 V CER X7R	02010	SR205C473MAAH
C37	0160-0575	1	CAP-FXD 0.047uF ± 20% 50 V CER X7R	02010	SR205C473MAAH
C38			FACTORY-SELECT VALUE		
C39	0160-4787	1	CAP-FXD 22pF ± 5% 100 V CER COG	02010	SA102A220JAAH
C40	0160-0575	1	CAP-FXD 0.047uF ± 20% 50 V CER X7R	02010	SR205C473MAAH
CR1	1901-0376	1	DIODE-GEN PRP 35V 50MA DO-35	11946	S303
CR2	1901-0050	1	DIODE-SWITCHING 80V 200MA 2NS DO-35	03334	BAV10 SELECTED
CR3	1901-0050	1	DIODE-SWITCHING 80V 200MA 2NS DO-35	03334	BAV10 SELECTED
CR4	1901-0050	1	DIODE-SWITCHING 80V 200MA 2NS DO-35	03334	BAV10 SELECTED
CR5	1901-0050	1	DIODE-SWITCHING 80V 200MA 2NS DO-35	03334	BAV10 SELECTED
CR6	1901-0050	1	DIODE-SWITCHING 80V 200MA 2NS DO-35	03334	BAV10 SELECTED
CR7	1901-0050	1	DIODE-SWITCHING 80V 200MA 2NS DO-35	03334	BAV10 SELECTED
CR8	1901-0050	1	DIODE-SWITCHING 80V 200MA 2NS DO-35	03334	BAV10 SELECTED
CR9	1901-0050	1	DIODE-SWITCHING 80V 200MA 2NS DO-35	03334	BAV10 SELECTED
CR10	1901-0050	1	DIODE-SWITCHING 80V 200MA 2NS DO-35	03334	BAV10 SELECTED
CR11	1901-0050	1	DIODE-SWITCHING 80V 200MA 2NS DO-35	03334	BAV10 SELECTED
CR12	1901-0050	1	DIODE-SWITCHING 80V 200MA 2NS DO-35	03334	BAV10 SELECTED
CR13	1901-0050	1	DIODE-SWITCHING 80V 200MA 2NS DO-35	03334	BAV10 SELECTED
CR14	1901-0050	1	DIODE-SWITCHING 80V 200MA 2NS DO-35	03334	BAV10 SELECTED
CR15	1901-0050	1	DIODE-SWITCHING 80V 200MA 2NS DO-35	03334	BAV10 SELECTED
CR16	1901-0050	1	DIODE-SWITCHING 80V 200MA 2NS DO-35	03334	BAV10 SELECTED
CR17	1901-0535	1	DIODE-SCHOTTKY SM SIG	02062	50825511
J1	1252-0937	1	CONN-POST TYPE .100-PIN-SPCG 8-CONT	01380	103166-2
J2	1252-0933	1	CONN-POST TYPE .100-PIN-SPCG 22-CONT	01380	103166-9
J4	1250-0257	1	CONNECTOR-RF SMB M PC-W-STDFS 50-OHM	05769	051-351-0049-226
J5	1250-0257	1	CONNECTOR-RF SMB M PC-W-STDFS 50-OHM	05769	051-351-0049-226
J6	1250-0257	1	CONNECTOR-RF SMB M PC-W-STDFS 50-OHM	05769	051-351-0049-226
K1	0490-1409	1	RELAY 2C 5VDC-COIL 2A 250VAC	01850	DS2E-S-DC5V-H121
K2	0490-1409	1	RELAY 2C 5VDC-COIL 2A 250VAC	01850	DS2E-S-DC5V-H121
L1	9100-3562	1	INDUCTOR RF-CH-MLD 4.7UH ± 5%	03273	15M471J
L2	9100-3562	1	INDUCTOR RF-CH-MLD 4.7UH ± 5%	03273	15M471J
L3	9100-3562	1	INDUCTOR RF-CH-MLD 4.7UH ± 5%	03273	15M471J
L4	9100-3562	1	INDUCTOR RF-CH-MLD 4.7UH ± 5%	03273	15M471J
L5	9100-3562	1	INDUCTOR RF-CH-MLD 4.7UH ± 5%	03273	15M471J
L6	9100-3562	1	INDUCTOR RF-CH-MLD 4.7UH ± 5%	03273	15M471J
MP2	1200-0173	3	INSULATOR-XSTR DAP-GL	02210	A-10001 DAP
P1	1251-8603	1	CONN-POST TYPE .100-PIN-SPCG 24-CONT	01380	1-534204-1

Table 6-2. Replaceable Parts

Ref Desig	HP Part Number	Qty	Description	Mfr Code	Mfr Part Number
Q1	1854-0295	1	TRANSISTOR-DUAL NPN TO-78 PD=400MW	02037	
Q2	1854-0295	1	TRANSISTOR-DUAL NPN TO-78 PD=400MW	02037	
Q3	1855-0525	1	TRANSISTOR MOSFET N-CHAN E-MODE SI	02883	VN0300M
Q4	1855-0525	1	TRANSISTOR MOSFET N-CHAN E-MODE SI	02883	VN0300M
Q5	1855-0386	1	TRANSISTOR J-FET 2N4392 N-CHAN D-MODE	02037	2N4392
Q6	1853-0316	1	TRANSISTOR-DUAL PNP PD=500MW	13127	LS352
Q7	1855-0646	1	TRANSISTOR MOSFET N-CHAN E-MODE TO-39 SI	03038	IRFF131
Q8	1855-0646	1	TRANSISTOR MOSFET N-CHAN E-MODE TO-39 SI	03038	IRFF131
Q9	1853-0075	1	TRANSISTOR-DUAL PNP PD=400MW	02037	
Q10	1853-0281	1	TRANSISTOR PNP 2N2907A SI TO-18 PD=400MW	02037	2N2907A
Q11	1854-0295	1	TRANSISTOR-DUAL NPN TO-78 PD=400MW	02037	
R1	0757-0290	1	RESISTOR 6.19K ± 1% .125W TF TC=0 ± 100	02995	SFR25H
R2	0757-1094	1	RESISTOR 1.47K ± 1% .125W TF TC=0 ± 100	02995	SFR25H
R3	0757-0346	1	RESISTOR 10 ± 1% .125W TF TC=0 ± 100	05524	CMF-55-1, T-1
R4	0698-8827	1	RESISTOR 1M ± 1% .125W TF TC=0 ± 100	02995	SFR25H
R5	0698-6782	1	RESISTOR 250 ± 0.1% .125W TF TC=0 ± 25	02995	5033R
R6	0698-6362	1	RESISTOR 1K ± 0.1% .125W TF TC=0 ± 25	02995	5033R
R7	0757-0280	1	RESISTOR 1K ± 1% .125W TF TC=0 ± 100	02995	SFR25H
R8	0698-0083	1	RESISTOR 1.96K ± 1% .125W TF TC=0 ± 100	02995	SFR25H
R9	0757-0438	1	RESISTOR 5.11K ± 1% .125W TF TC=0 ± 100	02995	SFR25H
R10	0757-0438	1	RESISTOR 5.11K ± 1% .125W TF TC=0 ± 100	02995	SFR25H
R11	0698-6348	1	RESISTOR 3K ± 0.1% .125W TF TC=0 ± 25	02995	5033R
R12	0698-8820	1	RESISTOR 4.64 ± 1% .125W TF TC=0 ± 100	05524	CMF-55-1
R13	0757-0346	1	RESISTOR 10 ± 1% .125W TF TC=0 ± 100	05524	CMF-55-1, T-1
R14	2100-3611	1	RESISTOR-TRMR 50K 10% TKF SIDE-ADJ	04568	67XR
R15	0757-0465	1	RESISTOR 100K ± 1% .125W TF TC=0 ± 100	02995	SFR25H
R16	0698-3153	1	RESISTOR 3.83K ± 1% .125W TF TC=0 ± 100	02995	SFR25H
R17	0757-0465	1	RESISTOR 100K ± 1% .125W TF TC=0 ± 100	02995	SFR25H
R18	0698-3159	1	RESISTOR 26.1K ± 1% .125W TF TC=0 ± 100	02995	SFR25H
R19	0757-0280	1	RESISTOR 1K ± 1% .125W TF TC=0 ± 100	02995	SFR25H
R20	0757-0467	1	RESISTOR 121K ± 1% .125W TF TC=0 ± 100	02995	SFR25H
R21	2100-3753	1	RESISTOR-TRMR 200K 10% TKF SIDE-ADJ	04568	67XR
R22	0757-0444	1	RESISTOR 12.1K ± 1% .125W TF TC=0 ± 100	02995	SFR25H
R23	2100-3611	1	RESISTOR-TRMR 50K 10% TKF SIDE-ADJ	04568	67XR
R25	0757-0439	1	RESISTOR 6.81K ± 1% .125W TF TC=0 ± 100	02995	SFR25H
R26	0698-6625	1	RESISTOR 6K ± 0.1% .125W TF TC=0 ± 25	02995	5033R
R27	0698-6360	1	RESISTOR 10K ± 0.1% .125W TF TC=0 ± 25	02995	5033R
R28	0698-6360	1	RESISTOR 10K ± 0.1% .125W TF TC=0 ± 25	02995	5033R
R29	0757-0280	1	RESISTOR 1K ± 1% .125W TF TC=0 ± 100	02995	SFR25H
R30	0757-0401	1	RESISTOR 100 ± 1% .125W TF TC=0 ± 100	02995	SFR25H
R32	0698-3449	1	RESISTOR 28.7K ± 1% .125W TF TC=0 ± 100	02995	SFR25H
R33	0757-0428	1	RESISTOR 1.62K ± 1% .125W TF TC=0 ± 100	02995	SFR25H
R34	2100-3732	1	RESISTOR-TRMR 500 10% TKF SIDE-ADJ	04568	67XR
R35	0757-0280	1	RESISTOR 1K ± 1% .125W TF TC=0 ± 100	02995	SFR25H
R36	0698-6364	1	RESISTOR 50 ± 0.1% .125W TF TC=0 ± 25	02995	5033R
R37	0757-0438	1	RESISTOR 5.11K ± 1% .125W TF TC=0 ± 100	02995	SFR25H
R38	0757-0280	1	RESISTOR 1K ± 1% .125W TF TC=0 ± 100	02995	SFR25H
R39	0698-3452	1	RESISTOR 147K ± 1% .125W TF TC=0 ± 100	02995	SFR25H
R40	0698-6625	1	RESISTOR 6K ± 0.1% .125W TF TC=0 ± 25	02995	5033R
R41	0698-3153	1	RESISTOR 3.83K ± 1% .125W TF TC=0 ± 100	02995	SFR25H
R42	0698-3154	1	RESISTOR 4.22K ± 1% .125W TF TC=0 ± 100	02995	SFR25H
R43	0698-6323	1	RESISTOR 100 ± 0.1% .125W TF TC=0 ± 25	05524	CMF-55-1, T-9
R44	0698-6377	1	RESISTOR 200 ± 0.1% .125W TF TC=0 ± 25	05524	CMF-55-1, T-9
R45	0698-6346	1	RESISTOR 300 ± 0.1% .125W TF TC=0 ± 25	02995	5033R
R46	0698-6355	1	RESISTOR 400 ± 0.1% .125W TF TC=0 ± 25	02995	5033R
R47	0698-6317	1	RESISTOR 500 ± 0.1% .125W TF TC=0 ± 25	05524	CMF-55-1, T-9
R48	0757-1100	1	RESISTOR 600 ± 1% .125W TF TC=0 ± 100	02995	SFR25H
R49	0698-4461	1	RESISTOR 698 ± 1% .125W TF TC=0 ± 100	05524	CMF-55-1, T-1
R50	0757-0421	1	RESISTOR 825 ± 1% .125W TF TC=0 ± 100	02995	SFR25H
R51	0757-0428	1	RESISTOR 1.62K ± 1% .125W TF TC=0 ± 100	02995	SFR25H
R52	0757-0280	1	RESISTOR 1K ± 1% .125W TF TC=0 ± 100	02995	SFR25H
R53	0757-0280	1	RESISTOR 1K ± 1% .125W TF TC=0 ± 100	02995	SFR25H
R54	0757-0280	1	RESISTOR 1K ± 1% .125W TF TC=0 ± 100	02995	SFR25H
R55	0757-0280	1	RESISTOR 1K ± 1% .125W TF TC=0 ± 100	02995	SFR25H
R56	0757-0280	1	RESISTOR 1K ± 1% .125W TF TC=0 ± 100	02995	SFR25H
R57	0757-0280	1	RESISTOR 1K ± 1% .125W TF TC=0 ± 100	02995	SFR25H
R58	0757-0280	1	RESISTOR 1K ± 1% .125W TF TC=0 ± 100	02995	SFR25H
R59	0757-0280	1	RESISTOR 1K ± 1% .125W TF TC=0 ± 100	02995	SFR25H
R60	2100-3611	1	RESISTOR-TRMR 50K 10% TKF SIDE-ADJ	04568	67XR
R61	2100-3611	1	RESISTOR-TRMR 50K 10% TKF SIDE-ADJ	04568	67XR
R62	2100-3611	1	RESISTOR-TRMR 50K 10% TKF SIDE-ADJ	04568	67XR
R63	2100-3611	1	RESISTOR-TRMR 50K 10% TKF SIDE-ADJ	04568	67XR

Table 6-2. Replaceable Parts

Ref Desig	HP Part Number	Qty	Description	Mfr Code	Mfr Part Number
R64	2100-3611	1	RESISTOR-TRMR 50K 10% TKF SIDE-ADJ	04568	67XR
R65	2100-3611	1	RESISTOR-TRMR 50K 10% TKF SIDE-ADJ	04568	67XR
R66	2100-3611	1	RESISTOR-TRMR 50K 10% TKF SIDE-ADJ	04568	67XR
R67	2100-3611	1	RESISTOR-TRMR 50K 10% TKF SIDE-ADJ	04568	67XR
R68	0757-0442	1	RESISTOR 10K $\pm 1\%$ .125W TF TC=0 $\pm 100$	02995	SFR25H
R69	0757-0442	1	RESISTOR 10K $\pm 1\%$ .125W TF TC=0 $\pm 100$	02995	SFR25H
R70	0757-0442	1	RESISTOR 10K $\pm 1\%$ .125W TF TC=0 $\pm 100$	02995	SFR25H
R71	0757-0442	1	RESISTOR 10K $\pm 1\%$ .125W TF TC=0 $\pm 100$	02995	SFR25H
R72	0757-0280	1	RESISTOR 1K $\pm 1\%$ .125W TF TC=0 $\pm 100$	02995	SFR25H
R73	0698-3153	1	RESISTOR 3.83K $\pm 1\%$ .125W TF TC=0 $\pm 100$	02995	SFR25H
R74	0757-0442	1	RESISTOR 10K $\pm 1\%$ .125W TF TC=0 $\pm 100$	02995	SFR25H
R75	0757-0438	1	RESISTOR 5.11K $\pm 1\%$ .125W TF TC=0 $\pm 100$	02995	SFR25H
R76	0757-0442	1	RESISTOR 10K $\pm 1\%$ .125W TF TC=0 $\pm 100$	02995	SFR25H
R77	0757-0280	1	RESISTOR 1K $\pm 1\%$ .125W TF TC=0 $\pm 100$	02995	SFR25H
R78	0683-2265	1	RESISTOR 22M $\pm 5\%$ .25W CC TC=-900/+1200	01607	CB2265
R79	2100-0545	1	RESISTOR-TRMR 1K 10% TKF SIDE-ADJ 17-TRN	04568	67XR
R80	0698-8827	1	RESISTOR 1M $\pm 1\%$ .125W TF TC=0 $\pm 100$	02995	SFR25H
R81	2100-3611	1	RESISTOR-TRMR 50K 10% TKF SIDE-ADJ	04568	67XR
R82	0757-0346	1	RESISTOR 10 $\pm 1\%$ .125W TF TC=0 $\pm 100$	05524	CMF-55-1, T-1
R83	0757-0465	1	RESISTOR 100K $\pm 1\%$ .125W TF TC=0 $\pm 100$	02995	SFR25H
R84	0757-0465	1	RESISTOR 100K $\pm 1\%$ .125W TF TC=0 $\pm 100$	02995	SFR25H
R85	0757-0280	1	RESISTOR 1K $\pm 1\%$ .125W TF TC=0 $\pm 100$	02995	SFR25H
R86	0698-3456	1	RESISTOR 287K $\pm 1\%$ .125W TF TC=0 $\pm 100$	02995	SFR25H
R87	0698-6624	1	RESISTOR 2K $\pm 0.1\%$ .125W TF TC=0 $\pm 25$	02995	5033R
R88	0757-0199	1	RESISTOR 21.5K $\pm 1\%$ .125W TF TC=0 $\pm 100$	02995	SFR25H
R89	2100-0670	1	RESISTOR-TRMR 10K 10% TKF SIDE-ADJ	04568	67XR
R90	0757-0401	1	RESISTOR 100 $\pm 1\%$ .125W TF TC=0 $\pm 100$	02995	SFR25H
R91	0757-0401	1	RESISTOR 100 $\pm 1\%$ .125W TF TC=0 $\pm 100$	02995	SFR25H
R93	0757-0401	1	RESISTOR 100 $\pm 1\%$ .125W TF TC=0 $\pm 100$	02995	SFR25H
R94	0698-3136	1	RESISTOR 17.8K $\pm 1\%$ .125W TF TC=0 $\pm 100$	02995	SFR25H
R95	0757-0280	1	RESISTOR 1K $\pm 1\%$ .125W TF TC=0 $\pm 100$	02995	SFR25H
R96	0757-0280	1	RESISTOR 1K $\pm 1\%$ .125W TF TC=0 $\pm 100$	02995	SFR25H
R97	0698-6364	1	RESISTOR 50 $\pm 0.1\%$ .125W TF TC=0 $\pm 25$	02995	5033R
R98	0757-0346	1	RESISTOR 10 $\pm 1\%$ .125W TF TC=0 $\pm 100$	05524	CMF-55-1, T-1
R99	0757-0441	1	RESISTOR 8.25K $\pm 1\%$ .125W TF TC=0 $\pm 100$	02995	SFR25H
R100	0698-3160	1	RESISTOR 31.6K $\pm 1\%$ .125W TF TC=0 $\pm 100$	02995	SFR25H
R101	0757-0289	1	RESISTOR 13.3K $\pm 1\%$ .125W TF TC=0 $\pm 100$	02995	SFR25H
R102	0757-0280	1	RESISTOR 1K $\pm 1\%$ .125W TF TC=0 $\pm 100$	02995	SFR25H
R103	0757-0289	1	RESISTOR 13.3K $\pm 1\%$ .125W TF TC=0 $\pm 100$	02995	SFR25H
R104	0757-0401	1	RESISTOR 100 $\pm 1\%$ .125W TF TC=0 $\pm 100$	02995	SFR25H
R105	0757-0401	1	RESISTOR 100 $\pm 1\%$ .125W TF TC=0 $\pm 100$	02995	SFR25H
R106	0757-0398	1	RESISTOR 75 $\pm 1\%$ .125W TF TC=0 $\pm 100$	02995	SFR25H
R107	0757-0398	1	RESISTOR 75 $\pm 1\%$ .125W TF TC=0 $\pm 100$	02995	SFR25H
R108	0757-0401	1	RESISTOR 100 $\pm 1\%$ .125W TF TC=0 $\pm 100$	02995	SFR25H
R109	0757-0280	1	RESISTOR 1K $\pm 1\%$ .125W TF TC=0 $\pm 100$	02995	SFR25H
RT1	0837-0345	1	THERMISTOR DISC 50K-OHM TC=-4.3%/C-DEG	05524	8M5002-1
RT2	0837-0342	1	THERMISTOR TUB WITH AXL LEADS 100-OHM	06784	1K101J
RT3	0837-0342	1	THERMISTOR TUB WITH AXL LEADS 100-OHM	06784	1K101J
TP1	0360-0535	1	CONNECTOR-SGL CONT TML-TS-PT	04055	
TP2	0360-0535	1	CONNECTOR-SGL CONT TML-TS-PT	04055	
TP3	0360-0535	1	CONNECTOR-SGL CONT TML-TS-PT	04055	
TP4	0360-0535	1	CONNECTOR-SGL CONT TML-TS-PT	04055	
TP5	0360-0535	1	CONNECTOR-SGL CONT TML-TS-PT	04055	
TP6	0360-0535	1	CONNECTOR-SGL CONT TML-TS-PT	04055	
TP7	0360-0535	1	CONNECTOR-SGL CONT TML-TS-PT	04055	
TP8	0360-0535	1	CONNECTOR-SGL CONT TML-TS-PT	04055	
TP9	0360-0535	1	CONNECTOR-SGL CONT TML-TS-PT	04055	
U1	1826-0785	1	IC OP AMP LOW-BIAS-H-IMPDU DUAL 8-DIP-C	02037	MC34002BU
U2	1858-0087	1	TRANSISTOR ARRAY 14-PIN PLSTC TO-116	02037	MPQ3904
U3	1858-0087	1	TRANSISTOR ARRAY 14-PIN PLSTC TO-116	02037	MPQ3904
U4	1826-0742	1	IC V RGLTR-V-REF-FXD 10V TO-5 PKG	03285	AD581J
U5	1826-0079	1	IC OP AMP WB 8-TO-99 PKG	03799	HA2-2625-5
U6	1826-0600	1	IC OP AMP LOW-BIAS-H-IMPDU QUAD 14-DIP-P	01698	TL074ACN
U7	1826-1049	1	IC OP AMP PRCN 8-DIP-C PKG	02180	OP-27GZ
U8	1826-0516	1	IC OP AMP WB 8-TO-99 PKG	02180	OP-17FJ
U9	1826-0601	1	IC OP AMP PRCN 8-TO-99 PKG	02180	OP-16FJ
U10	1826-0785	1	IC OP AMP LOW-BIAS-H-IMPDU DUAL 8-DIP-C	02037	MC34002BU
U11	1826-0601	1	IC OP AMP PRCN 8-TO-99 PKG	02180	OP-16FJ
U12	1826-0601	1	IC OP AMP PRCN 8-TO-99 PKG	02180	OP-16FJ
U13	1826-0601	1	IC OP AMP PRCN 8-TO-99 PKG	02180	OP-16FJ
U14	1820-0224	1	IC OP AMP SPCL 8-TO-99 PKG	03406	LH0002CH
VR1	1902-1173	1	DIODE-ZNR 1N4104 10V 5% PD=.5W IR=1UA	02037	
W3	08349-60068	1	W3 CABLE ASSEMBLY	28480	08349-60068

Table 6-2. Replaceable Parts

REF DESIG	HP PART NUMBER	QTY	DESCRIPTION	MFR CODE	MFR PART NUMBER
A5	08349-600104*	1	BD AY-REGULATOR	28480	08349-60104
C1	0180-3394	1	CAP-FXD +50% -10% 25 V AL-ELCTLT	00493	SL25P103T30X51LL
C2	0180-3132	1	CAP-FXD 4700uF ± 20% 35 V AL-ELCTLT	00493	SM35VP472M25X40
C3	0180-3395	1	CAP-FXD 1000uF ± 20% 200 V AL-ELCTLT	00493	KM200VR102M35X50
C4	0180-3395	1	CAP-FXD 1000uF ± 20% 200 V AL-ELCTLT	00493	KM200VR102M35X50
C5	0180-0291	1	CAP-FXD 1uF ± 10% 35 V TA	04200	150D105X9035A2-DYS
C6	0180-0291	1	CAP-FXD 1uF ± 10% 35 V TA	04200	150D105X9035A2-DYS
C7	0180-0291	1	CAP-FXD 1uF ± 10% 35 V TA	04200	150D105X9035A2-DYS
C8	0180-0291	1	CAP-FXD 1uF ± 10% 35 V TA	04200	150D105X9035A2-DYS
C9	0180-4280	1	CAP-FXD 1uF ± 20% 50 V TA	28480	0180-4280
C10	0180-4280	1	CAP-FXD 1uF ± 20% 50 V TA	28480	0180-4280
C11	0180-0291	1	CAP-FXD 1uF ± 10% 35 V TA	04200	150D105X9035A2-DYS
C12	0180-0291	1	CAP-FXD 1uF ± 10% 35 V TA	04200	150D105X9035A2-DYS
C15	0180-0116	1	CAP-FXD 6.8uF ± 10% 35 V TA	04200	150D685X9035B2-DYS
C16	0180-0116	1	CAP-FXD 6.8uF ± 10% 35 V TA	04200	150D685X9035B2-DYS
C17	0180-0116	1	CAP-FXD 6.8uF ± 10% 35 V TA	04200	150D685X9035B2-DYS
C18	0180-0116	1	CAP-FXD 6.8uF ± 10% 35 V TA	04200	150D685X9035B2-DYS
C20	0180-0168	1	CAP-FXD 0.1uF ± 10% 200 V POLYE-FL	05176	HEW238T
C21	0160-0168	1	CAP-FXD 0.1uF ± 10% 200 V POLYE-FL	05176	HEW238T
C22	0160-0168	1	CAP-FXD 0.1uF ± 10% 200 V POLYE-FL	05176	HEW238T
C24	0180-4535	1	CAP-FXD 1uF ± 10% 50 V CER X7R	09939	RPE113-130X7R105K50V
C25	0160-4535	1	CAP-FXD 1uF ± 10% 50 V CER X7R	09939	RPE113-130X7R105K50V
C26	0180-4535	1	CAP-FXD 1uF ± 10% 50 V CER X7R	09939	RPE113-130X7R105K50V
C27	0160-4535	1	CAP-FXD 1uF ± 10% 50 V CER X7R	09939	RPE113-130X7R105K50V
C28	0160-3879	1	CAP-FXD 0.01uF ± 20% 100 V CER X7R	02010	SR201C103MAAH
CR1	1901-0935	1	DIODE-PWR RECT 45V 8A	03038	
CR2	1901-0935	1	DIODE-PWR RECT 45V 8A	03038	
CR3	1901-0935	1	DIODE-PWR RECT 45V 8A	03038	
CR4	1901-0935	1	DIODE-PWR RECT 45V 8A	03038	
CR5	1901-0693	1	DIODE-PWR RECT 100V 1A 200NS DO-41	04504	1N4934
CR6	1901-0693	1	DIODE-PWR RECT 100V 1A 200NS DO-41	04504	1N4934
CR7	1901-0693	1	DIODE-PWR RECT 100V 1A 200NS DO-41	04504	1N4934
CR8	1901-0693	1	DIODE-PWR RECT 100V 1A 200NS DO-41	04504	1N4934
CR10	1901-0965	1	DIODE-PWR RECT 100V 3A 200NS	02037	
CR11	1901-0965	1	DIODE-PWR RECT 100V 3A 200NS	02037	
CR12	1901-0965	1	DIODE-PWR RECT 100V 3A 200NS	02037	
CR13	1901-0965	1	DIODE-PWR RECT 100V 3A 200NS	02037	
CR17	1901-0028	1	DIODE-PWR RECT 400V 750MA DO-29	02664	SS5117
CR18	1901-0028	1	DIODE-PWR RECT 400V 750MA DO-29	02664	SS5117
CR19	1901-0028	1	DIODE-PWR RECT 400V 750MA DO-29	02664	SS5117
CR20	1901-0028	1	DIODE-PWR RECT 400V 750MA DO-29	02664	SS5117
CR21	1901-0028	1	DIODE-PWR RECT 400V 750MA DO-29	02664	SS5117
CR22	1901-0028	1	DIODE-PWR RECT 400V 750MA DO-29	02664	SS5117
CR23	1901-0028	1	DIODE-PWR RECT 400V 750MA DO-29	02664	SS5117
CR24	1901-0028	1	DIODE-PWR RECT 400V 750MA DO-29	02664	SS5117
CR25	1901-0028	1	DIODE-PWR RECT 400V 750MA DO-29	02664	SS5117
CR26	1901-0028	1	DIODE-PWR RECT 400V 750MA DO-29	02664	SS5117
CR27	1901-0028	1	DIODE-PWR RECT 400V 750MA DO-29	02664	SS5117
CR28	1901-0028	1	DIODE-PWR RECT 400V 750MA DO-29	02664	SS5117
CR29	1901-0662	1	DIODE-PWR RECT 100V 6A	02037	MR751
DS1	1990-0485	1	LED-LAMP LUM-INT = 2MCD IF = 30MA-MAX BVR = 5V	01542	HLMP-1503
DS2	1990-0485	1	LED-LAMP LUM-INT = 2MCD IF = 30MA-MAX BVR = 5V	01542	HLMP-1503
DS3	1990-0485	1	LED-LAMP LUM-INT = 2MCD IF = 30MA-MAX BVR = 5V	01542	HLMP-1503
DS4	1990-0485	1	LED-LAMP LUM-INT = 2MCD IF = 30MA-MAX BVR = 5V	01542	HLMP-1503
F1	2110-0332	1	FUSE (INCH) 3A 125V NTD BI	02805	GMW 3
F2	2110-0425	1	FUSE (INCH) 2A 125V NTD BI	02805	GMW 2A
F3	2110-0424	1	FUSE (INCH) .75A 125V NTD BI	02805	GMW 3/4A
F4	2110-0476	1	FUSE (INCH) 4A 125V NTD BI	02805	GMW-4
F5	2110-0425	1	FUSE (INCH) 2A 125V NTD BI	02805	GMW 2A
F6	2110-0424	1	FUSE (INCH) .75A 125V NTD BI	02805	GMW 3/4A
F7	2110-0424	1	FUSE (INCH) .75A 125V NTD BI	02805	GMW 3/4A
J1	1251-8032	1	CONN-POST TYPE .156-PIN-SPCG 8-CONT	03418	26-60-4080
MP2	1200-0173	4	INSULATOR-XSTR DAP-GL	02210	A-10001 DAP
MP3	0380-1861	2	THREADED INSERT-STDF M2.5 X 0.45	03981	KFB3-M2.5-20
MP4	1205-0011	4	HEAT SINK TO-5/TO-39-CS	05792	TXBF-032-025B

\*This assembly is a direct replacement for the 08349-60040

Table 6-2. Replaceable Parts

REF DESIG	HP PART NUMBER	QTY	DESCRIPTION	MFR CODE	MFR PART NUMBER
MP5	0380-1246	4	SPACER-RVT-ON 6-MM-LG 3.8-MM-ID	02121	
P1	1251-8603	1	CONN-POST TYPE. 100-PIN-SPCG 24-CONT	01380	1-534204-1
Q1	1884-0073	1	THYRISTOR-SCR VRRM = 100	02037	
Q2	1884-0316	1	THYRISTOR-SCR VRRM = 200		
Q3	1884-0073	1	THYRISTOR-SCR VRRM = 100	02037	
Q4	1884-0073	1	THYRISTOR-SCR VRRM = 100	02037	
Q5	1884-0073	1	THYRISTOR-SCR VRRM = 100	02037	
R1	0757-0416	1	RESISTOR 511 ± 1% .125W TF TC = 0 ± 100	02995	SFR25H
R2	0698-3444	1	RESISTOR 316 ± 1% .125W TF TC = 0 ± 100	02995	SFR25H
R3	0698-3444	1	RESISTOR 316 ± 1% .125W TF TC = 0 ± 100	02995	SFR25H
R4	0698-3444	1	RESISTOR 316 ± 1% .125W TF TC = 0 ± 100	02995	SFR25H
R5	0757-0442	1	RESISTOR 10K ± 1% .125W TF TC = 0 ± 100	02995	SFR25H
R6	0757-0403	1	RESISTOR 121 ± 1% .125W TF TC = 0 ± 100	02995	SFR25H
R7	0757-0419	1	RESISTOR 681 ± 1% .125W TF TC = 0 ± 100	02995	SFR25H
R8	0698-3132	1	RESISTOR 261 ± 1% .125W TF TC = 0 ± 100	02995	SFR25H
R10	0757-0421	1	RESISTOR 825 ± 1% .125W TF TC = 0 ± 100	02995	SFR25H
R11	0757-0405	1	RESISTOR 162 ± 1% .125W TF TC = 0 ± 100	02995	SFR25H
R12	0698-0083	1	RESISTOR 1.96K ± 1% .125W TF TC = 0 ± 100	02995	SFR25H
R13	0757-0405	1	RESISTOR 162 ± 1% .125W TF TC = 0 ± 100	02995	SFR25H
R14	0698-0083	1	RESISTOR 1.96K ± 1% .125W TF TC = 0 ± 100	02995	SFR25H
R15	0757-0442	1	RESISTOR 10K ± 1% .125W TF TC = 0 ± 100	02995	SFR25H
R16	0757-0442	1	RESISTOR 10K ± 1% .125W TF TC = 0 ± 100	02995	SFR25H
R17	0757-0346	1	RESISTOR 10 ± 1% .125W TF TC = 0 ± 100	05524	CMF-55-1, T-1
R18	0757-0346	1	RESISTOR 10 ± 1% .125W TF TC = 0 ± 100	05524	CMF-55-1, T-1
R19	0698-3601	1	RESISTOR 10 ± 5% 2W MO TC = 0 ± 200	02499	GS-3
R20	0698-3601	1	RESISTOR 10 ± 5% 2W MO TC = 0 ± 200	02499	GS-3
R21	0757-0280	1	RESISTOR 1K ± 1% .125W TF TC = 0 ± 100	02995	SFR25H
R22	0757-0280	1	RESISTOR 1K ± 1% .125W TF TC = 0 ± 100	02995	SFR25H
R23	0757-0280	1	RESISTOR 1K ± 1% .125W TF TC = 0 ± 100	02995	SFR25H
R24	0757-0280	1	RESISTOR 1K ± 1% .125W TF TC = 0 ± 100	02995	SFR25H
R25	0757-0401	1	RESISTOR 100 ± 1% .125W TF TC = 0 ± 100	02995	SFR25H
R26	0757-0401	1	RESISTOR 100 ± 1% .125W TF TC = 0 ± 100	02995	SFR25H
R27	0757-0401	1	RESISTOR 100 ± 1% .125W TF TC = 0 ± 100	02995	SFR25H
R28	0757-0401	1	RESISTOR 100 ± 1% .125W TF TC = 0 ± 100	02995	SFR25H
R29	0757-0346	1	RESISTOR 10 ± 1% .125W TF TC = 0 ± 100	05524	CMF-55-1, T-1
R30	0698-3444	1	RESISTOR 316 ± 1% .125W TF TC = 0 ± 100	02995	SFR25H
R31	0698-3444	1	RESISTOR 316 ± 1% .125W TF TC = 0 ± 100	02995	SFR25H
R32	0698-3444	1	RESISTOR 316 ± 1% .125W TF TC = 0 ± 100	02995	SFR25H
R33	0698-3444	1	RESISTOR 316 ± 1% .125W TF TC = 0 ± 100	02995	SFR25H
R34	0698-3444	1	RESISTOR 316 ± 1% .125W TF TC = 0 ± 100	02995	SFR25H
R35	2100-3755	1	RESISTOR-TRMR 50 10% TKF SIDE-ADJ 17-TRN	04568	67XR
R36	2100-3755	1	RESISTOR-TRMR 50 10% TKF SIDE-ADJ 17-TRN	04568	67XR
R37	0757-0442	1	RESISTOR 10K ± 1% .125W TF TC = 0 ± 100	02995	SFR25H
R38	2100-3755	1	RESISTOR-TRMR 50 10% TKF SIDE-ADJ 17-TRN	04568	67XR
R39	2100-3755	1	RESISTOR-TRMR 50 10% TKF SIDE-ADJ 17-TRN	04568	67XR
TP1	0380-0535	1	CONNECTOR-SGL CONT TML-TS-PT	04055	
TP2	0380-0535	1	CONNECTOR-SGL CONT TML-TS-PT	04055	
TP3	0380-0535	1	CONNECTOR-SGL CONT TML-TS-PT	04055	
TP4	0380-0535	1	CONNECTOR-SGL CONT TML-TS-PT	04055	
TP5	0380-0535	1	CONNECTOR-SGL CONT TML-TS-PT	04055	
TP6	0380-0535	1	CONNECTOR-SGL CONT TML-TS-PT	04055	
VR1	1902-0958	1	DIODE-ZNR 10V 5% DO-35 PD = .4W TC = + .075%	02037	
VR2	1902-0953	1	DIODE-ZNR 6.2V 5% DO-35 PD = .4W TC = + .053%	02037	SZ30035-11RL
VR3	1902-3224	1	DIODE-ZNR 17.8V 5% DO-35 PD = .4W	02037	
VR4	1902-3224	1	DIODE-ZNR 17.8V 5% DO-35 PD = .4W	02037	
VR5	1902-1413	1	DIODE-ZNR 36.0V 5% DO-35 PD = .4W	02037	
VR6	1902-3182	1	DIODE-ZNR 12.1V 5% DO-35 PD = .4W	02037	
VR7	1902-3182	1	DIODE-ZNR 12.1V 5% DO-35 PD = .4W	02037	
X1	1251-2313	14	CONNECTOR-SGL CONT SKT .04-IN-BSC-SZ RND	01380	3-332070-5

Table 6-2. Replaceable Parts

Ref Desig	HP Part Number	Qty	Description	Mfr Code	Mfr Part Number
A6	08349-60075	1	BD AY-MTHR	28480	08349-60075
J1	1251-8494	1	CONN-POST TYPE .100-PIN-SPCG 24-CONT	01380	534978-4
J2	1251-8494	1	CONN-POST TYPE .100-PIN-SPCG 24-CONT	01380	534978-4
J3	1252-0638	1	CONN-POST TYPE .100-PIN-SPCG 10-CONT	01380	103168-3
J4	1251-8494	1	CONN-POST TYPE .100-PIN-SPCG 24-CONT	01380	534978-4
J5	1252-0208	1	CONN-POST TYPE .100-PIN-SPCG 24-CONT	01380	1-103166-0
J6	1200-1205	1	SOCKET-IC-DIP 16-CONT DIP DIP-SLDR	01380	2-641610-2
MP2	0380-1258	5	STANDOFF-PRESS-IN 16.00 MM LG; M 3.0 X	03981	KFSE-M3-16
R1	0757-0442	1	RESISTOR 10K $\pm$ 1% .125W TF TC=0 $\pm$ 100	02995	SFR25H
VR1	1902-1429	1	DIODE-ZNR 5.11V 2% DO-35 PD= .4W	02037	



Table 6-2. Replaceable Parts

Ref Desig	HP Part Number	Qty	Description	Mfr Code	Mfr Part Number
			<b>MISCELLANEOUS PARTS</b>		
MP28	7120-0255	1	LABEL-SERIAL NUMBER	28480	7120-0255
MP33	5001-3907	1	RTNR LINE MODULE	28480	5001-3907
	5061-9689		FRONT HANDLE KIT (OPT 907)	28480	5061-9689
	08349-60042	1	FRONT PANEL ASSY	28480	08349-60042
	08349-60041	1	REAR PANEL ASSY	28480	08349-60041
	5040-0345		INSULATOR CONN	28480	5040-0345
	08349-60056	1	FRT PNL ASSY-001	28480	08349-60056
	08349-60054	1	RR PNL ASSY-001	28480	08349-60054
	08349-20035	1	HOLE PLUG-001		
	08349-20035	2	HOLE PLUG-002		
	1252-1840	1	CONNECTOR DUST COVER		
			<b>CABLES &amp; CONNECTORS</b>		
W1	08349-20015	1	CA RF IN FRT OPT 001	28480	08349-20015
W1	08349-20014	1	CA RF IN RR OPT 002	28480	08349-20014
W1	08349-20009	1	CABLE RF INPUT	28480	08349-20009
W2	08349-20010	1	CABLE RF OUTPUT	28480	08349-20010
W3	08349-60068	1	W3 CABLE ASSEMBLY (A4)	28480	08349-60068
W4	08349-60055	1	W4 CABLE AY-001	28480	08349-60055
W4	08349-60051	1	W4 CA AY STD/002	28480	08349-60051
W5	08349-60048	1	J3 CABLE ASSY	28480	08349-60048
W6	08349-60053	1	J4 CABLE ASSY	28480	08349-60053
W7	08349-60014	1	CABLE ASSY RIBBON	28480	08349-60014
W8	08349-60050	1	CA AY-MM CON-001	28480	08349-60050
W8	08349-60049	1	CA AY-MM STD/002	28480	08349-60049
W9	08349-60052	1	CA AY-INTFC CONN	28480	08349-60052
			<b>SERVICE ACCESSORIES</b>		
	08349-00005	1	EXTENDER BRACKET (BOTH HEAT SINKS)	28480	08349-00005
	08349-60059	1	REGULATOR/SIGNAL CONDITIONING EXTENDER BOARD	28480	08349-60059
	09349-60058	1	BIAS EXTENDER BOARD	28480	08349-60058
	9222-0339	1	BAG-PLASTIC POLYETH FLM ENV 4-OPNG 10-DP	28480	9222-0339
			<b>ATTACHING HARDWARE</b>		
9	3060-1186		WASHER-SHLDR NO. 4 .12-IN-ID .25-IN-OD	28480	3050-1186
19	0360-0037	1	TERMINAL-SLDR LUG PL-MTG FOR-#6-SCR	28480	0360-0037
22	0330-1422	2	SPACER-RND 20-MM-LG 4.5MM ID 8MM		
23	0390-0006	4	INSULATOR-FLG-BSHG NYLON	28480	0390-0006
27	0515-0335	4	SCREW-MACH M4 X 0.7 70MM-LG-PAN-HD	28480	0515-0335
34	3050-0239	4	WASHER-FL NM NO. 8 .17-ID .375-IN-OD	28480	3050-0239

FRONT VIEW

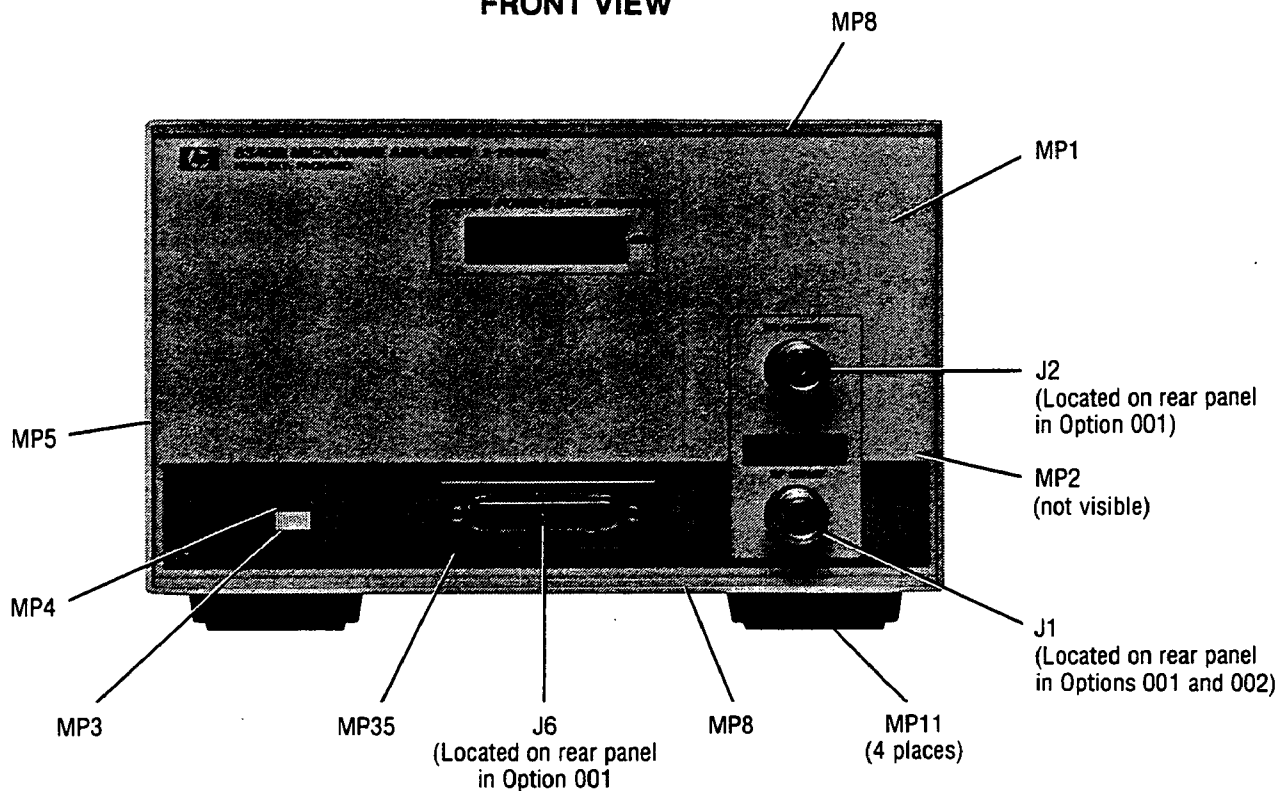

Ref Desig	HP Part Number	Qty	Description	Mfr Code	Mfr Part Number
MP1	08349-00012	1	DRESS PANEL	28480	08349-00012
MP2	08349-00015	1	SUB PANEL-LWR	28480	08349-00015
MP3	0370-3068	1	KEY ON-OFF WHITE	28480	0370-3068
MP4	0370-0914	1	BEZEL-PB KNOB, .490LG.,.330W.,.165HI,JADE	28480	0370-0914
MP5	5021-8415	1	FRAME-FRONT	28480	5021-5815
MP7			NOT ASSIGNED		
MP8	08349-40003	1	UPPER RETAINER	28480	08349-40003
MP8	08349-40004	1	LOWER RETAINER	28480	08349-40004
MP11	5040-8801	4	FOOT BOTTOM	28480	5040-7201
MP34			NOT ASSIGNED		
MP35	08349-40001	1	BEZEL	28480	08349-40001
J1	86290-60005	1	CONNECTOR TYPE-N F (RF OUTPUT)	28480	86290-60005
J2	86290-60005	1	CONNECTOR TYPE-N F (RF OUTPUT)	28480	86290-60005
J6			SEE CABLE ASSY W8		

Figure 6-1. Miscellaneous Parts, Front View (1 of 7)

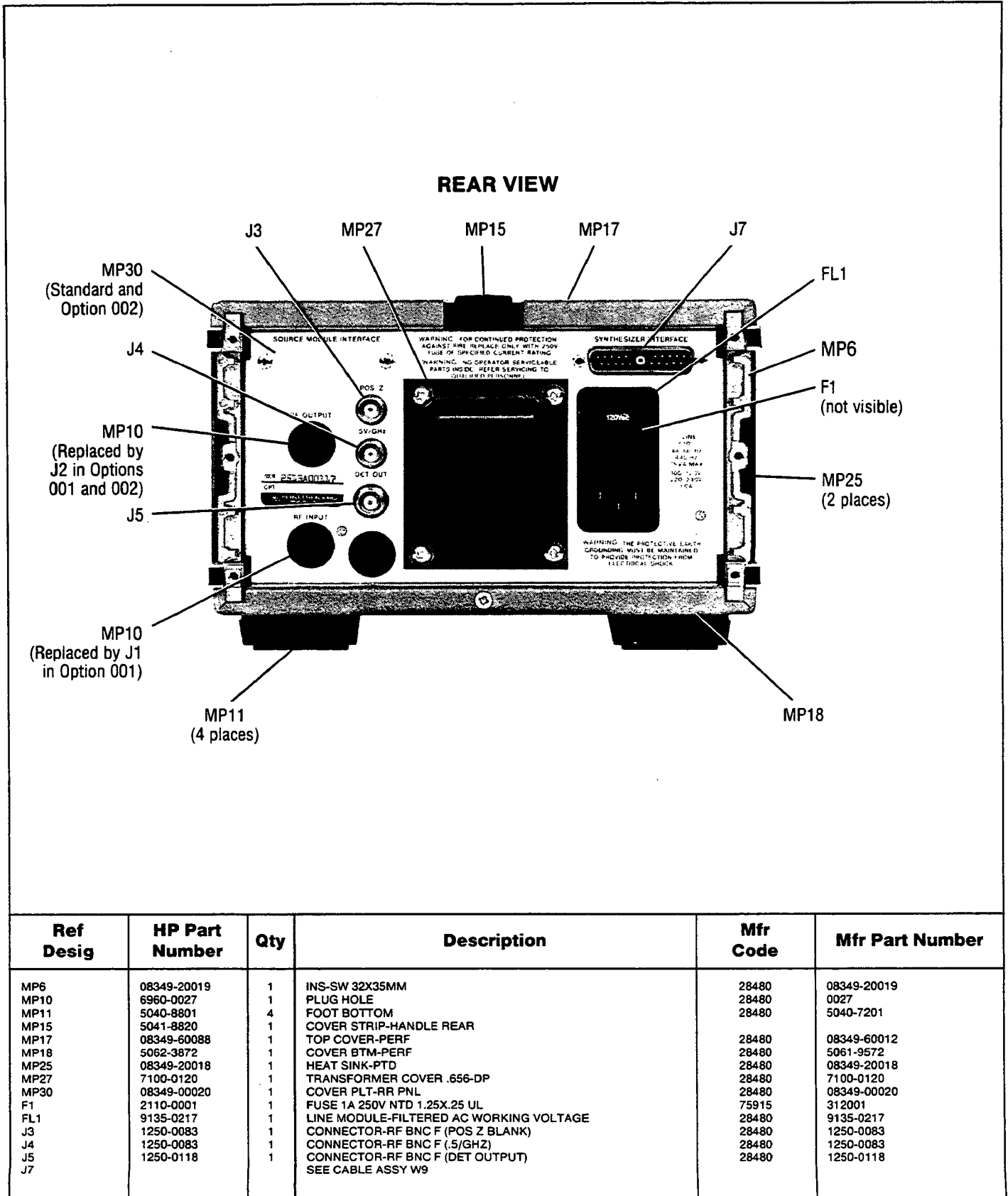
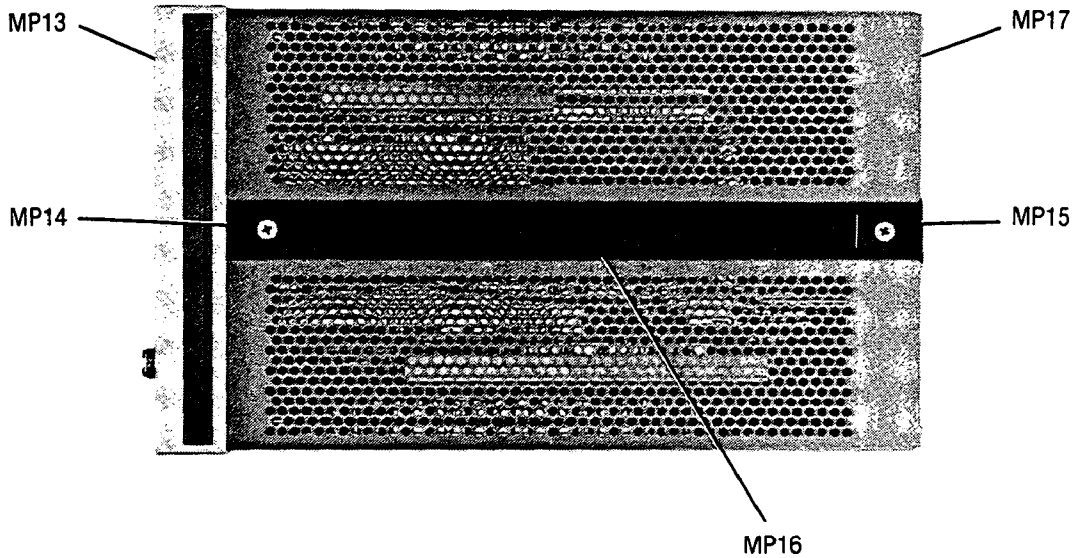

Figure 6-1. Miscellaneous Parts, Rear View (2 of 7)

TOP VIEW WITH COVERS



Ref Desig	HP Part Number	Qty	Description	Mfr Code	Mfr Part Number
MP13	5041-8803	1	TOP TRIM STRIP	28480	5040-7203
MP14	5041-8819	1	COVER STRIP-HANDLE FRONT		
MP15	5041-8820	1	COVER STRIP-HANDLE REAR		
MP16	5060-3702	1	HANDLE	28480	5060-9802
MP17	08349-60088	1	TOP COVER-PERF	28480	08349-60012

Figure 6-1. Miscellaneous Parts, Top View with Covers (3 of 7)

**TOP VIEW WITHOUT COVERS**

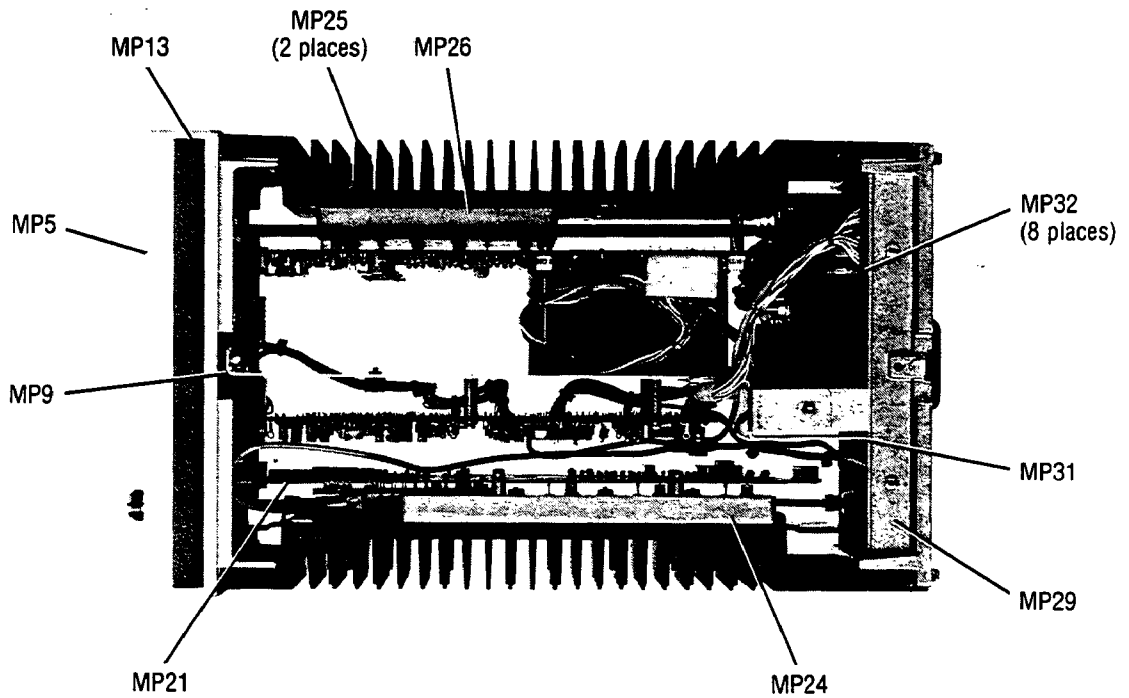

Ref Desig	HP Part Number	Qty	Description	Mfr Code	Mfr Part Number
MP5	5021-8415	1	FRAME-FRONT	28480	5021-5815
MP9	08349-00025	1	CENTER SUPPORT (RECOMMENDED REPLACEMENT)	28480	08349-00025
MP13	5041-8803	1	TOP TRIM STRIP	28480	5040-7203
MP21	0360-2023	1	TERMINAL BLOCK-40 TERMINAL	28480	0360-2023
MP24	08349-20008	1	TRANSISTOR BLOCK	28480	08349-20008
MP25	08349-20018	1	HEAT SINK-PTD	28480	08349-20018
MP26	08349-20007	1	REGULATOR BLOCK	28480	08349-20007
MP29	08349-00014	1	REAR PANEL	28480	08349-00014
MP31	08349-00021	1	SHIELD	28480	08349-00019
MP32	1251-8167	6	CONNECTOR-SGL CONT QDISC-FEM	28480	1251-8167

Figure 6-1. Miscellaneous Parts, Top View without Covers (4 of 7)

**RIGHT SIDE**

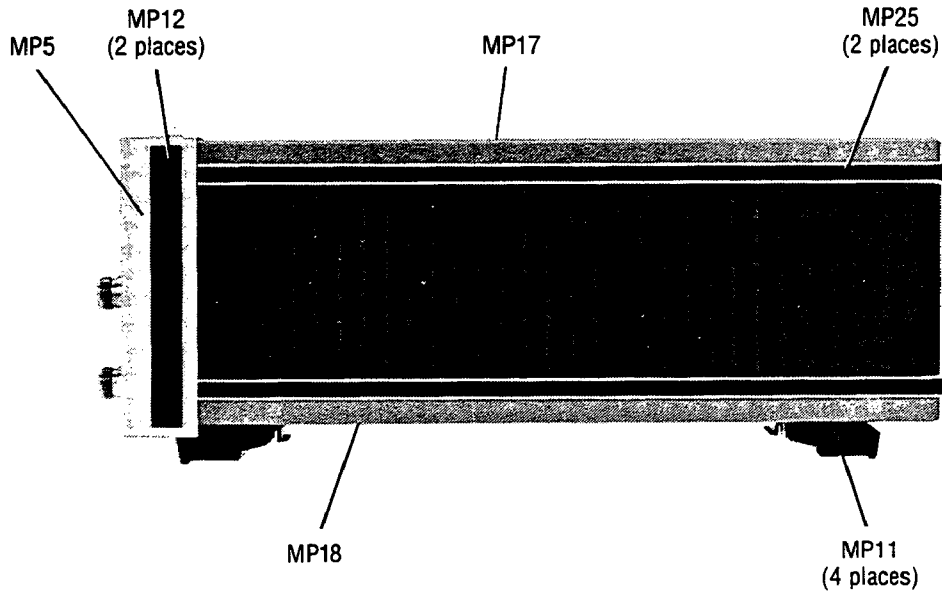

Ref Desig	HP Part Number	Qty	Description	Mfr Code	Mfr Part Number
MP5	5021-8415	1	FRAME-FRONT	28480	5021-5815
MP11	5040-8801	4	FOOT BOTTOM	28480	5040-7201
MP12	5001-0539	2	TRIM SIDE FRONT	28480	5001-0439
MP17	08349-60088	1	TOP COVER-PERF	28480	08349-60012
MP18	5062-3872	1	COVER BTM-PERF	28480	5061-9572
MP25	08349-20018	1	HEAT SINK-PTD	28480	08349-20018

Figure 6-1. Miscellaneous Parts, Right Side (5 of 7)

**BOTTOM VIEW WITHOUT COVERS**

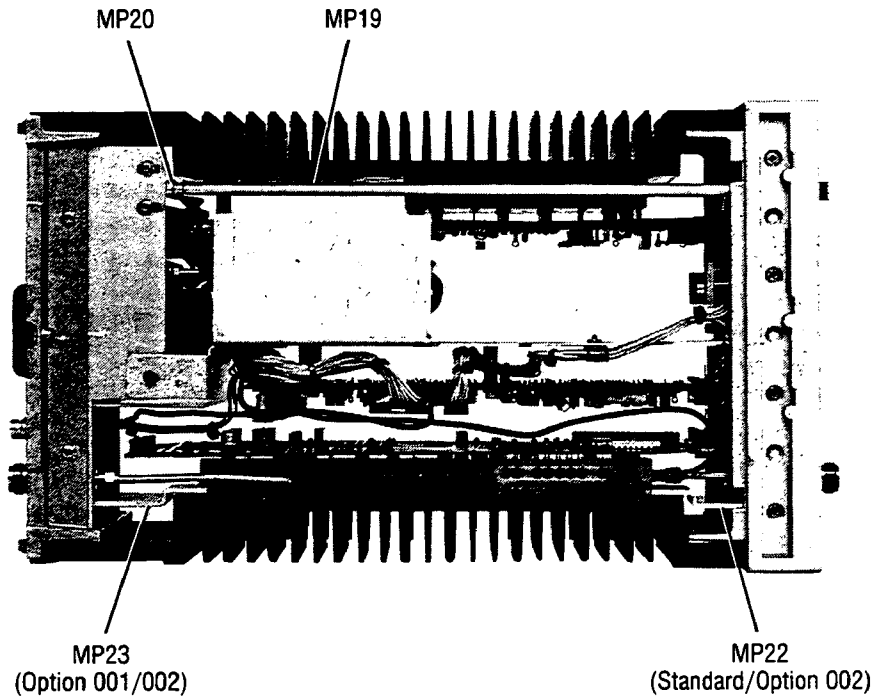

Ref Desig	HP Part Number	Qty	Description	Mfr Code	Mfr Part Number
MP19	08349-20012	1	PUSH BUTTON ROD	28480	08349-20012
MP20	00438-20025	1	PU	28480	2848000438-20025
MP22	08349-00018	1	BRACKET RF CONNECTOR	28480	08349-00018
MP23	08349-00010	1	BRACKET RF CONNECTOR (OPT 001/002)	28480	08349-00010

*Miscellaneous Parts, Bottom View without Covers (6 of 7)*

## INSIDE REAR PANEL

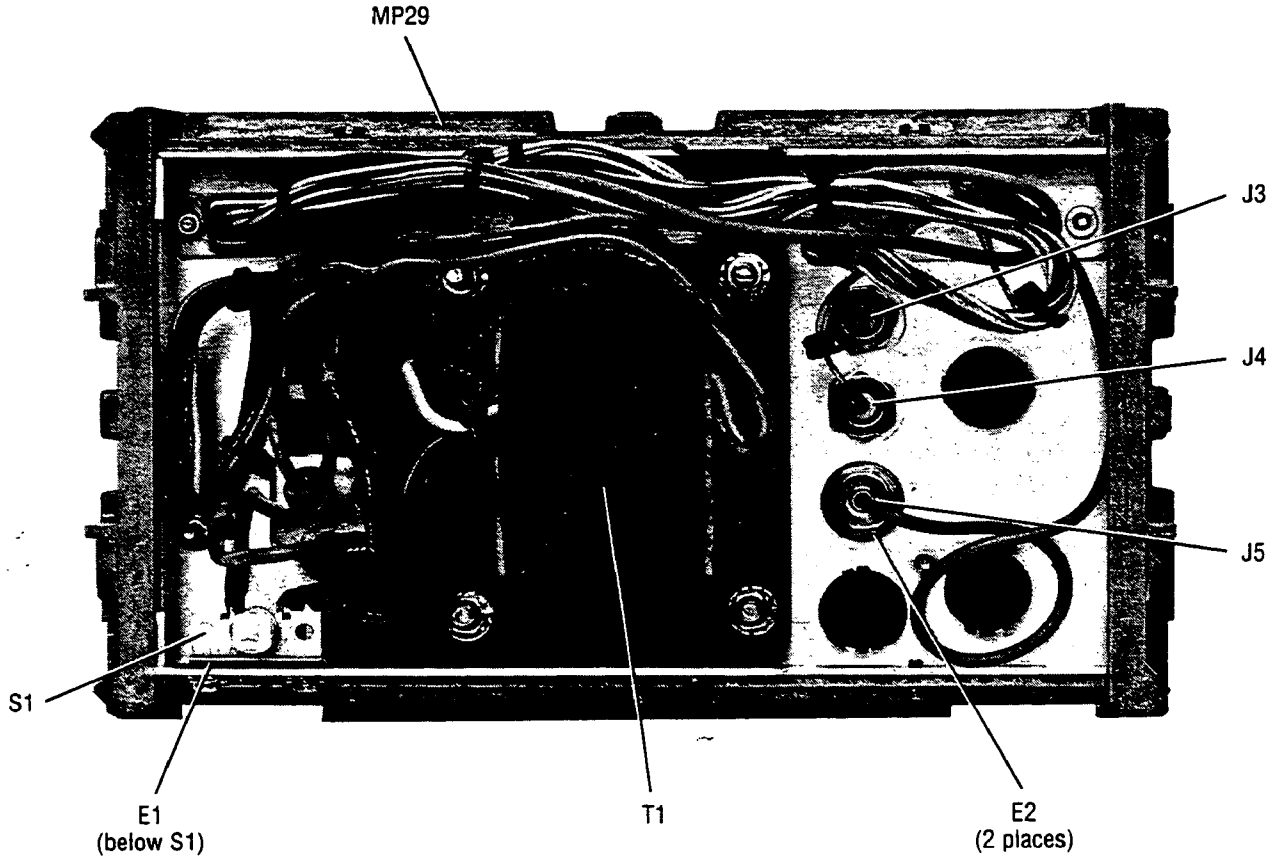

Ref Desig	HP Part Number	Qty	Description	Mfr Code	Mfr Part Number
MP29	08349-00014	1	REAR PANEL	28480	08349-00014
S1	3101-2779	1	SWITCH-PB DPST ALTNG 4A 250 VAC	28480	3101-2779
T1	9100-4481	1	XFMR PWR	28480	9100-4481
J3	1250-0083	1	CONNECTOR-RF BNC F (POS Z BLANK)	28480	1250-0083
J4	1250-0083	1	CONNECTOR-RF BNC F (.5/GHZ)	28480	1250-0083
J5	1250-0118	1	CONNECTOR-RF BNC F (DET OUTPUT)	28480	1250-0118

*Miscellaneous Parts, Inside Rear Panel (7 of 7)*



## REAR VIEW

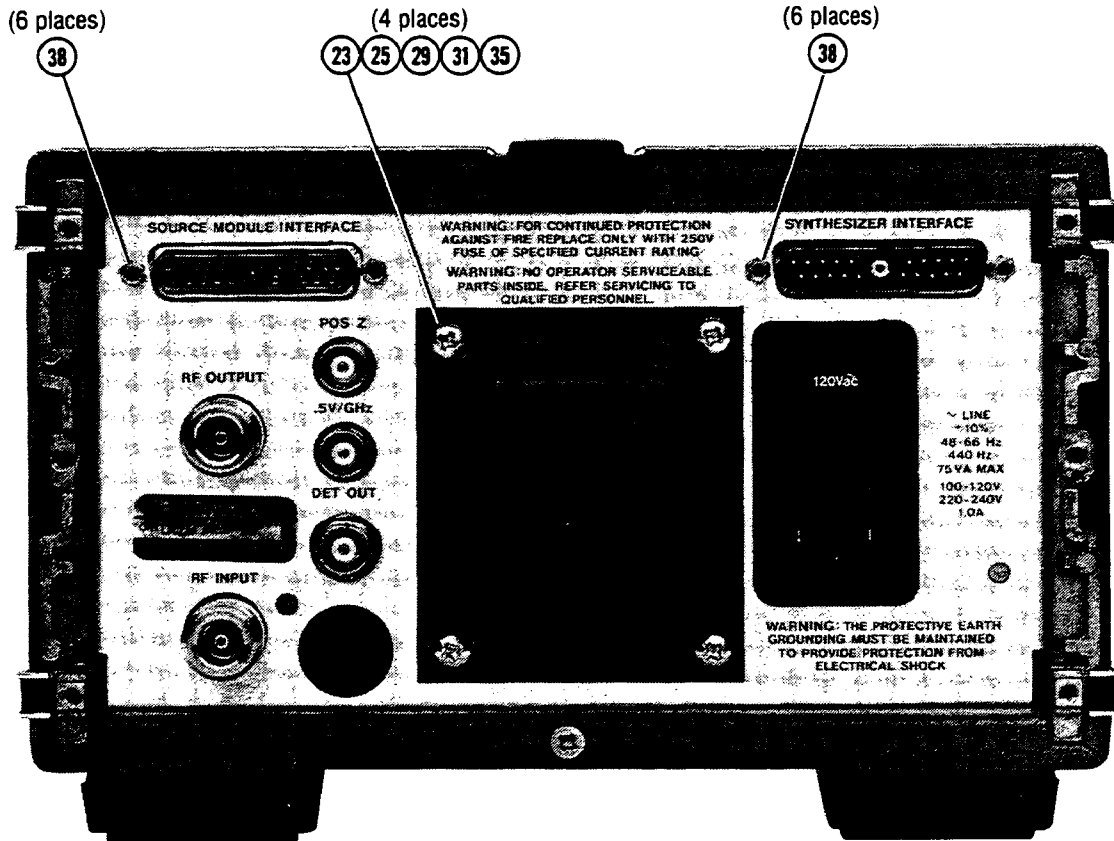

Ref Desig	HP Part Number	Qty	Description	Mfr Code	Mfr Part Number
23	0390-0006	4	INSULATOR-FLG-BSHG NYLON	28480	0390-0006
25	0515-0335	2	SCREW-MACH M4 X 0.7 50MM-LG	28480	0515-0335
29	0535-0006	4	NUT HEX DBL-CHAM M4 X 0.7 3.2MM-THK	28480	ORDER BY DESCRIPTION
31	2190-0010	4	WASHER-LK EXT T NO. 8 .166-1N-ID	28480	2190 0010
35	3050-0139	4	WASHER-FL MTLC NO. 8 .172-IN-ID	28480	3050-0139
38	1251-2942	6	SCREW-MACH		

Figure 6-2. Attaching Hardware, Rear View (1 of 9)

## INSIDE FRONT PANEL ASSEMBLY

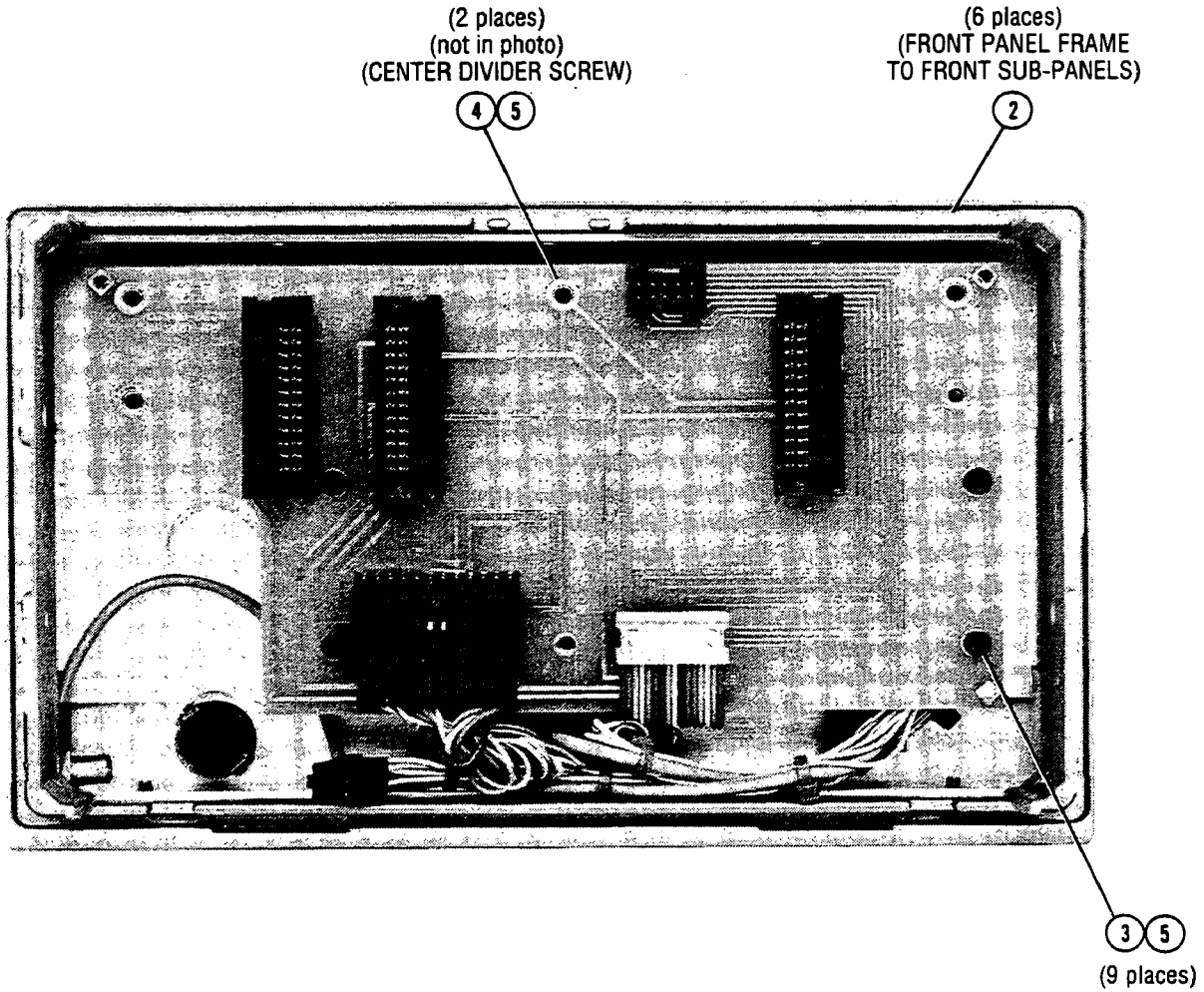

Ref Desig	HP Part Number	Qty	Description	Mfr Code	Mfr Part Number
2	0515-0219	12	SCREW MACH M3 X 0.5 6MM-LG	00000	ORDER BY DESCRIPTION
3	0515-0481	5	SCREW-SKT HD-CAP M3 X 0.5 6MM-LG	00000	ORDER BY DESCRIPTION
4	0515-0484	8	SCREW-SKIT-HD-CAP M3 X 0.5 12MM-LB	28480	2190-0584
5	2190-0584		WASHER-LK HLCL 3.0 MM 3.1-MM-ID		

Figure 6-2. Attaching Hardware, Inside Front Panel Assembly (2 of 9)

## INSIDE REAR PANEL

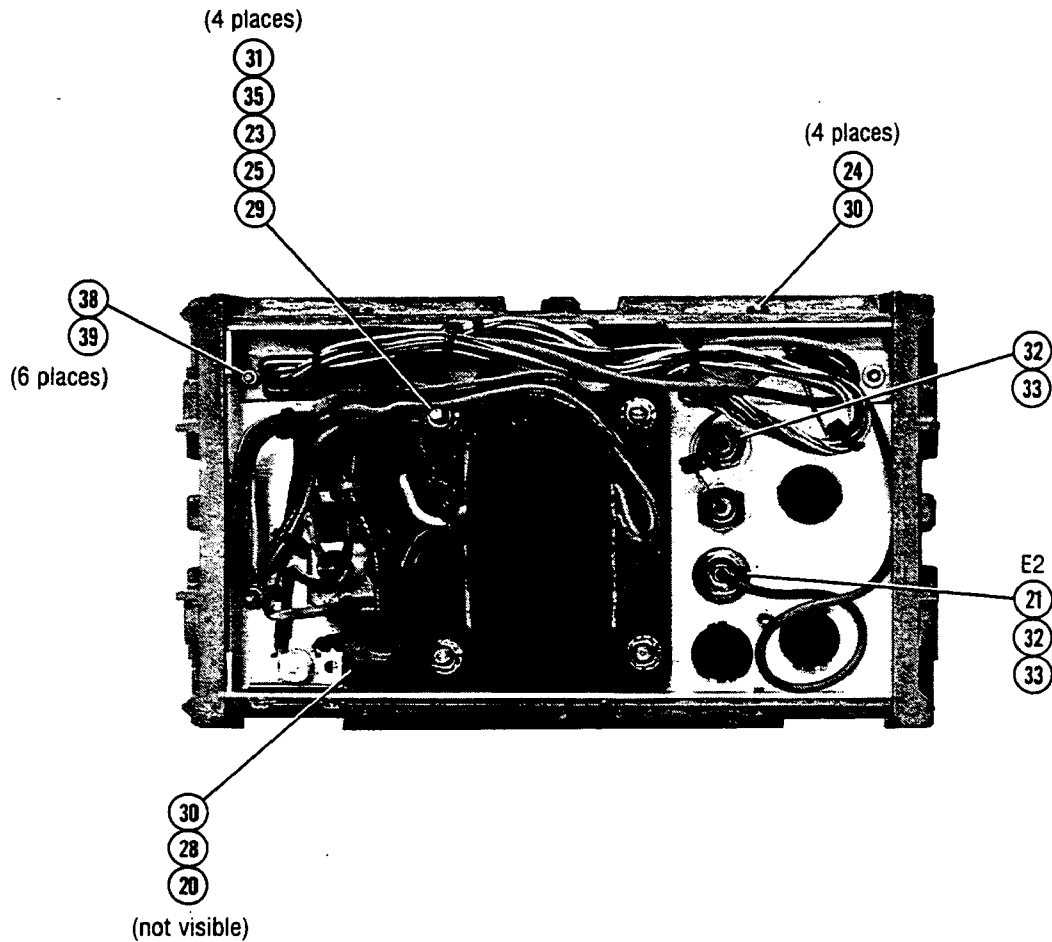

Ref Desig	HP Part Number	Qty	Description	Mfr Code	Mfr Part Number
20	0360-0042	1	TERMINAL-SLDR LUG PL-MTG FOR #6-SCR	28480	0360-0042
21	0360-1190	1	TERMINAL-SLDR LUG PL-MTG FOR #3/8-SCR	28480	0360-1190
23	0390-0006	4	INSULATOR-FLG-BSHG NYLON	28480	0390-0006
24	0515-0924	4	SCREW-MACH M3 X 0.5-LG		
24	0515-0924	4	SCREW-MACH M3 X 0.5 6MM-LG PAN HD	28480	0515-0924
25	0515-0335	2	SCREW-MACH M4 X 0.7 50MM-LG		
28	0535-00042		NUT-HEX DBL-CHAM M3 X 0.5 2.4MM-THK	00000	ORDER BY DESCRIPTION
29	0535-0006	4	NUT HEX DBL-CHAM M4 X 0.7 3.2MM-THK	28480	ORDER BY DESCRIPTION
30	2190-0005	8	WASHER-LK EXT T NO. 4 .116-IN-ID	28480	2190-0005
31	2190-0010	4	WASHER-LK EXT T NO. 8 .166-IN-ID	28480	2190 0010
32	2190-0016	3	WASHER-LK INTL 3/8 IN .377-IN-ID	28480	2190-0016
33	2950-0001	3	NUT-HEX-DBL-CHAM 3/8-32-THD .094-IN-THK	00000	ORDER BY DESCRIPTION
35	3050-0139	4	WASHER-FL MTLCL NO. 8 .172-IN-ID	28480	3050-0139
38	1251-2942	6	SCREW-MACH		
39	1251-2942		SCREW-MACH		

Figure 6-2. Attaching Hardware, Inside Rear Panel (3 of 9)

**TOP VIEW WITH COVERS**

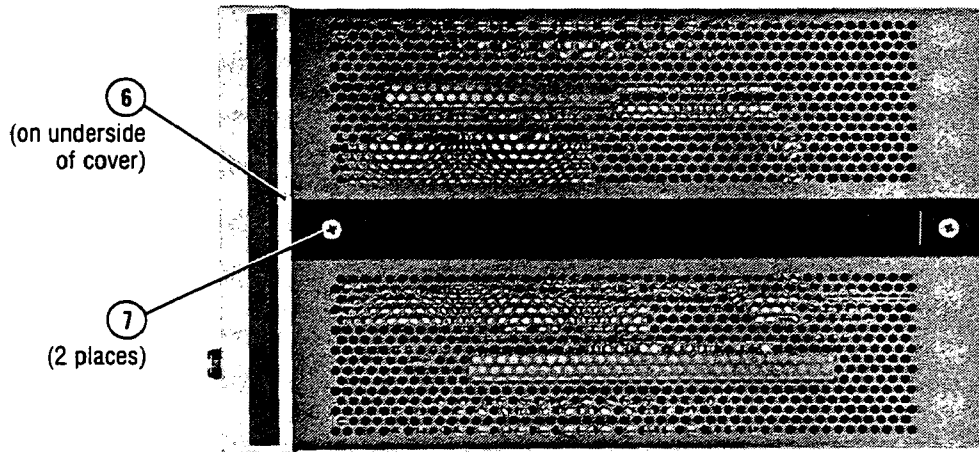

Ref Desig	HP Part Number	Qty	Description	Mfr Code	Mfr Part Number
6	0535-0091	2	NUT-HEX W/EXT-T-LKMR M5 X 0.8 3.3MM THK	28480	0515-1132
7	0515-1132		SCREW-MACH M5 X 0.8 10MM-LG		

*Figure 6-2. Attaching Hardware, Top View with Covers (4 of 9)*

TOP VIEW WITHOUT COVERS

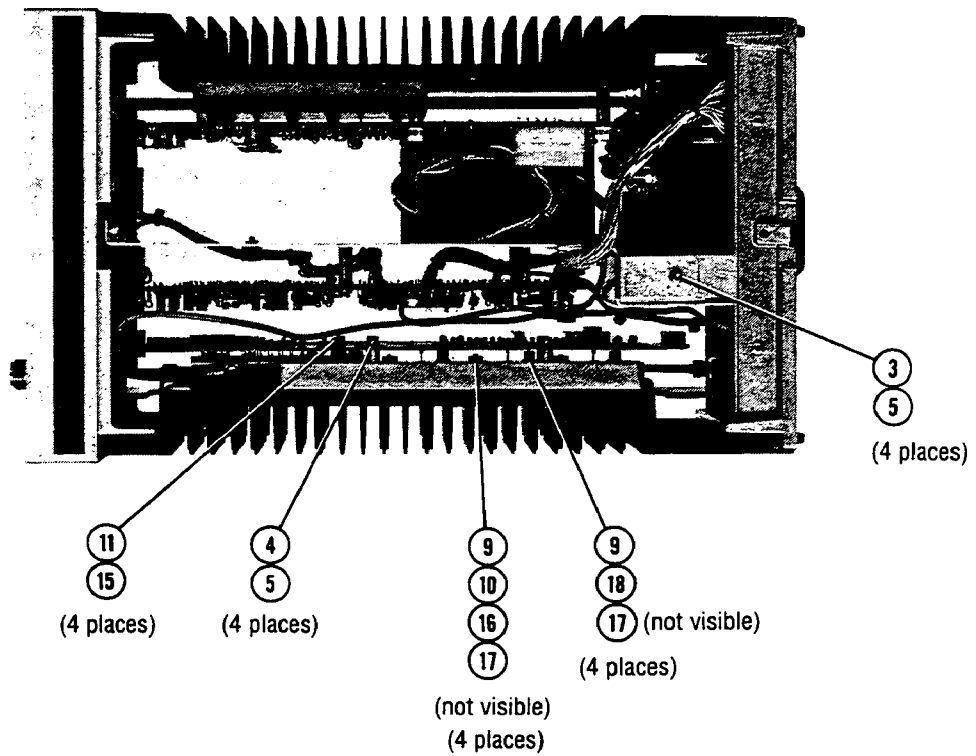

Ref Desig	HP Part Number	Qty	Description	Mfr Code	Mfr Part Number
3	0515-0481	5	SCREW-SKT HD-CAP M3 X 0.5 6MM-LG	00000	ORDER BY DESCRIPTION
4	0515-0484	8	SCREW-SKIT-HD-CAP M3 X 0.5 12MM-LB	00000	ORDER BY DESCRIPTION
5	2190-0584		WASHER-LK HLCL 3.0 MM 3.1-MM-ID	28480	2190-0584
9	3060-1186		WASHER-SHLDR NO. 4 .12-IN-ID .25-IN-OD	28480	3050-1186
10	3050-0105	9	WASHER-FL MTLC NO. 4 .125-1N-ID	28480	3050-0105
11	0515-0478	4	SCREW-SKT-HD-CAP M2.5 X 0.45 12MM-LG	28480	0515-0478
15	2190-0583		WASHER-LK HLCL 2.5 MM 2.6-MM-ID	28480	2190-0583
16	2200-0143	4	SCREW-MACH 4-40 .375-1N-LG PAN-HD-POZI	28480	2200-0143
17	2260-0009	16	NUT-HEX-W/LKWR 4-40-THD .094-IN-THK	00000	ORDER BY DESCRIPTION
18	350-20004	12	CONNECTOR PIN THREADED		

Figure 6-2. Attaching Hardware, Top View without Covers (5 of 9)

### BOTTOM VIEW WITHOUT COVERS

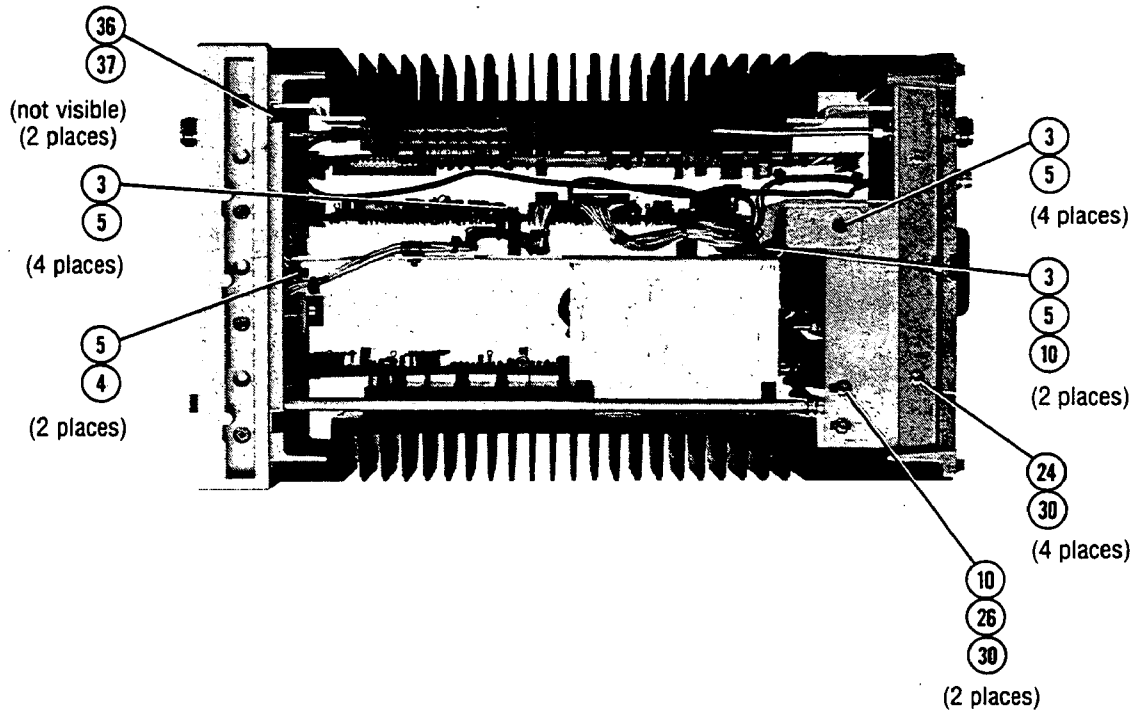

Ref Desig	HP Part Number	Qty	Description	Mfr Code	Mfr Part Number
3	0515-0481	5	SCREW-SKT HD-CAP M3 X 0.5 6MM-LG	00000	ORDER BY DESCRIPTION
4	0515-0484	8	SCREW-SKIT-HD-CAP M3 X 0.5 12MM-LB	00000	ORDER BY DESCRIPTION
5	2190-0584		WASHER-LK HLCL 3.0 MM 3.1-MM-ID	28480	2190-0584
10	3050-0105	9	WASHER-FL MTLC NO. 4 .125-1N-ID	28480	3050-0105
24	0515-0924	4	SCREW-MACH M3 X 0.5-LG		
24	0515-0924	4	SCREW-MACH M3 X 0.5 6MM-LG PAN HD	28480	0515-0924
26	0515-0150	2	SCREW-MACH M2.5 X 0.45 6MM-LG		
30	2190-0005	8	WASHER-LK EXT T NO. 4 .116-IN-ID	28480	2190-0005
36	2950-0132	2	NUT-HEX-DBL-CHAM 7/16-28-THD .094-IN-THK	00000	ORDER BY DESCRIPTION
37	2190-0104	2	WASHER-LK INTL T 7/16 IN .439-IN-ID	28480	2190-0104

*Attaching Hardware, Bottom View without Covers (6 of 9)*

LEFT SIDE

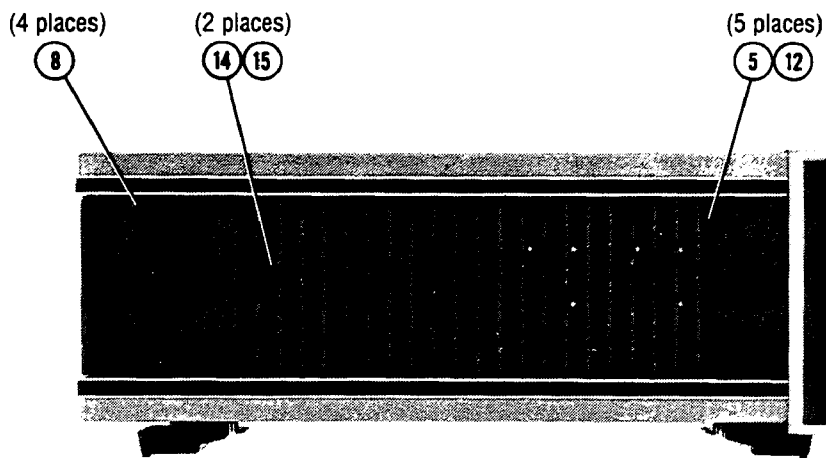

Ref Desig	HP Part Number	Qty	Description	Mfr Code	Mfr Part Number
5	2190-0584			28480	2190-0584
8	3030-0950	8	WASHER-LK HLCL 3.0 MM 3.1-MM-ID		
12	0515-0965		SCREW-SKT FL HD CAP 8-32 .375-IN. LG.	28480	0515-0965
14	0515-0967	10	SCREW-SKIT-HD-CAP M3 X 0.5 14MM-LG		
15	2190-0583		WASHER-LK HLCL 2.5 MM 2.6-MM-ID	28480	2190-0583

Figure 6-2. Attaching Hardware, Left Side (7 of 9)

**RIGHT SIDE**

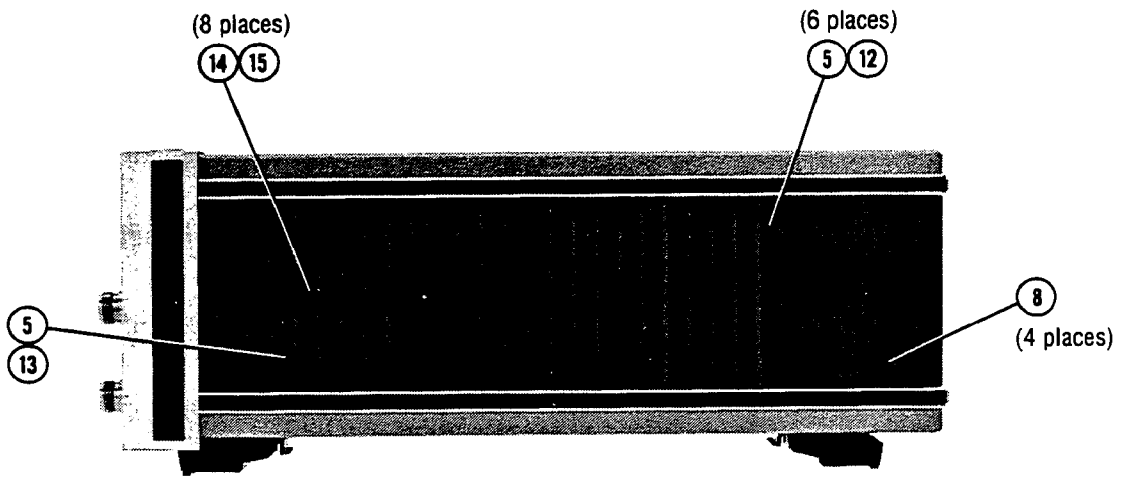

Ref Desig	HP Part Number	Qty	Description	Mfr Code	Mfr Part Number
5	2190-0584	10	WASHER-LK HLCL 3.0 MM 3.1-MM-ID	28480	2190-0584
8	3030-0950		SCREW-SKT FL HD CAP 8-32 .375-IN. LG.	28480	0515-0965
12	0515-0965		SCREW-SKT-HD-CAP M3 X 0.5 14MM-LG	28480	0515-0966
13	0515-0966		SCREW-SKT-HD-CAP M3 X 0.5 8MM-LG	28480	2190-0583
14	0515-0967		SCREW-SKT-HD-CAP M2.5 X 0.45 8MM-LG	28480	
15	2190-0583		WASHER-LK HLCL 2.5 MM 2.6-MM-ID		

Figure 6-2. Attaching Hardware, Right Side (8 of 9)



## POWER SUPPLY REGULATOR BLOCK

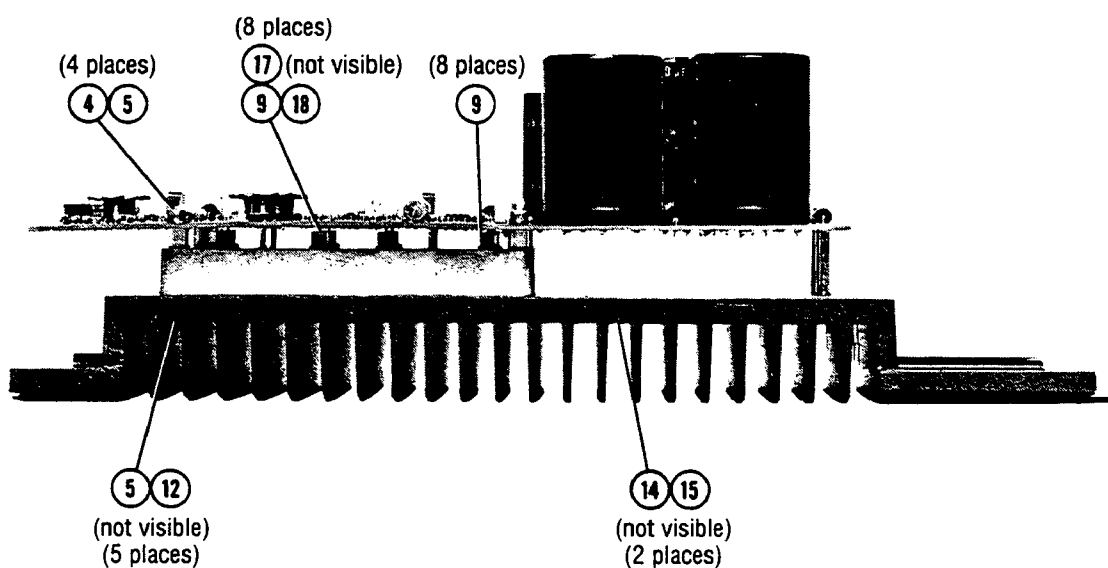

Ref Desig	HP Part Number	Qty	Description	Mfr Code	Mfr Part Number
5	2190-0584		WASHER-LK HLCL 3.0 MM 3.1-MM-ID	28480	2190-0584
9	3060-1186		WASHER-SHLDR NO. 4 .12-IN-ID .25-IN-OD	28480	3050-1186
12	0515-0965		SCREW-SKT-HD-CAP M3 X 0.5 14MM-LG	28480	0515-0965
14	0515-0967	10	SCREW-SKT-HD-CAP M2.5 X 0.45 8MM-LG		
15	2190-0583		WASHER-LK HLCL 2.5 MM 2.6-MM-ID	28480	2190-0583
17	2260-0009	16	NUT-HEX-W/LKWR 4-40-THD .094-IN-THK	00000	ORDER BY DESCRIPTION
18	08350-20004	12	CONNECTOR PIN THREADED		
U1*	1826-0677		+8V REGULATOR	28480	1826-0677
U2*	1826-0677		+5V REGULATOR	28480	1826-0677
U3*	1826-0423		+15V REGULATOR	28480	1826-0423
U4*	1826-0523		-15V REGULATOR	28480	1826-0523
			*NOT SHOWN		

Figure 6-2. Attaching Hardware, Power Supply Regulator Block (9 of 9)



## Section 7. Manual Backdating

---

### INTRODUCTION

This manual has been written for and applies directly to instruments with serial numbers prefixed as indicated on the title page. Earlier versions of the instrument (serial numbers prefixed lower than the ones indicated on the title page) may be slightly different in design or appearance.

The purpose of this section of the manual is to provide information so this manual can be corrected so that it applies to the instruments with the serial prefix numbers listed below. To perform the adaptation, refer to Table 7-1 and make the manual backdating changes listed opposite your instrument serial number or serial number prefix.

For additional important information about serial number coverage, refer to INSTRUMENTS COVERED BY THE MANUAL in Section 1.

*Table 7-1. Manual Backdating Changes by Serial Number Prefix*

Serial Prefix	Make Manual Changes
2644A	C
2627A	B, C
2548A, 2513A	A, B,C

## **CHANGE A**

The following changes apply directly to the instruments with the serial prefix opposite this lettered change in Table 7-1 and should be used when servicing them.

**Replace the existing manual pages with the following pages:**

Title Page

6-14

8-25/8-26

8-48

# **HP 8349B MICROWAVE AMPLIFIER**

## **SERIAL NUMBERS**

This manual applies directly to HP 8349B Microwave Amplifier having serial numbers prefixed 2513A and 2548A.

For additional information about serial numbers, refer to INSTRUMENTS COVERED BY MANUAL in Section 1.

©Copyright                      HEWLETT-PACKARD COMPANY                      1985  
1400 FOUNTAINGROVE PARKWAY, SANTA ROSA, CA 95403 U.S.A.

MANUAL PART NO. 08349-90017

Printed: APRIL 1991



**HEWLETT  
PACKARD**

Change A

## **CERTIFICATION**

*Hewlett-Packard Company certifies that this product met its published specifications at the time of shipment from the factory. Hewlett-Packard further certifies that its calibration measurements are traceable to the United States National Institute of Standards and Technology (NIST, formerly NBS), to the extent allowed by the Institute's calibration facility, and to the calibration facilities of other International Standards Organization members.*

## **WARRANTY**

This Hewlett-Packard instrument product is warranted against defects in material and workmanship for a period of one year from date of delivery. During the warranty period, Hewlett-Packard Company will, at its option, either repair or replace products which prove to be defective.

For warranty service or repair, this product must be returned to a service facility designated by HP. Buyer shall prepay shipping charges to HP and HP shall pay shipping charges to return the product to Buyer. However, Buyer shall pay all shipping charges, duties, and taxes for products returned to HP from another country.

HP warrants that its software and firmware designated by HP for use with an instrument will execute its programming instructions when properly installed on that instrument. HP does not warrant that the operation of the instrument, or software, or firmware will be uninterrupted or error free.

### **LIMITATION OF WARRANTY**

The foregoing warranty shall not apply to defects resulting from improper or inadequate maintenance by Buyer, Buyer-supplied software or interfacing, unauthorized modification or misuse, operation outside of the environmental specifications for the product, or improper site preparation or maintenance.

**NO OTHER WARRANTY IS EXPRESSED OR IMPLIED. HP SPECIFICALLY DISCLAIMS THE IMPLIED WARRANTIES OF MERCHANTABILITY AND FITNESS FOR A PARTICULAR PURPOSE.**

### **EXCLUSIVE REMEDIES**

**THE REMEDIES PROVIDED HEREIN ARE BUYER'S SOLE AND EXCLUSIVE REMEDIES. HP SHALL NOT BE LIABLE FOR ANY DIRECT, INDIRECT, SPECIAL, INCIDENTAL, OR CONSEQUENTIAL DAMAGES, WHETHER BASED ON CONTRACT, TORT, OR ANY OTHER LEGAL THEORY.**

## **ASSISTANCE**

*Product maintenance agreements and other customer assistance agreements are available for Hewlett-Packard products.*

*For any assistance, contact your nearest Hewlett-Packard Sales and Service Office. Addresses are provided at the back of this manual.*

Table 6-2. Replaceable Parts

Ref Desig	HP Part Number	Qty	Description	Mfr Code	Mfr Part Number
R1	0757-0416	1	RESISTOR 511 $\pm 1\%$ .125W TF TC= $0 \pm 100$	02995	SFR25H
R2	0698-3444	1	RESISTOR 316 $\pm 1\%$ .125W TF TC= $0 \pm 100$	02995	SFR25H
R3	0698-3444	1	RESISTOR 316 $\pm 1\%$ .125W TF TC= $0 \pm 100$	02995	SFR25H
R4	0698-3444	1	RESISTOR 316 $\pm 1\%$ .125W TF TC= $0 \pm 100$	02995	SFR25H
R5	0757-0442	1	RESISTOR 10K $\pm 1\%$ .125W TF TC= $0 \pm 100$	02995	SFR25H
R6	0757-0403	1	RESISTOR 121 $\pm 1\%$ .125W TF TC= $0 \pm 100$	02995	SFR25H
R7	0757-0419	1	RESISTOR 681 $\pm 1\%$ .125W TF TC= $0 \pm 100$	02995	SFR25H
R8	0698-3132	1	RESISTOR 261 $\pm 1\%$ .125W TF TC= $0 \pm 100$	02995	SFR25H
R10	0757-0421	1	RESISTOR 825 $\pm 1\%$ .125W TF TC= $0 \pm 100$	02995	SFR25H
R11	0757-0405	1	RESISTOR 162 $\pm 1\%$ .125W TF TC= $0 \pm 100$	02995	SFR25H
R12	0698-0083	1	RESISTOR 1.96K $\pm 1\%$ .125W TF TC= $0 \pm 100$	02995	SFR25H
R13	0757-0405	1	RESISTOR 162 $\pm 1\%$ .125W TF TC= $0 \pm 100$	02995	SFR25H
R14	0698-0083	1	RESISTOR 1.96K $\pm 1\%$ .125W TF TC= $0 \pm 100$	02995	SFR25H
R15	0757-0442	1	RESISTOR 10K $\pm 1\%$ .125W TF TC= $0 \pm 100$	02995	SFR25H
R16	0757-0442	1	RESISTOR 10K $\pm 1\%$ .125W TF TC= $0 \pm 100$	02995	SFR25H
R17	0757-0346	1	RESISTOR 10 $\pm 1\%$ .125W TF TC= $0 \pm 100$	05524	CMF-55-1, T-1
R18	0757-0346	1	RESISTOR 10 $\pm 1\%$ .125W TF TC= $0 \pm 100$	05524	CMF-55-1, T-1
R19	0698-3601	1	RESISTOR 10 $\pm 5\%$ 2W MO TC= $0 \pm 200$	02499	GS-3
R20	0698-3601	1	RESISTOR 10 $\pm 5\%$ 2W MO TC= $0 \pm 200$	02499	GS-3
R21	0757-0280	1	RESISTOR 1K $\pm 1\%$ .125W TF TC= $0 \pm 100$	02995	SFR25H
R22	0757-0280	1	RESISTOR 1K $\pm 1\%$ .125W TF TC= $0 \pm 100$	02995	SFR25H
R23	0757-0280	1	RESISTOR 1K $\pm 1\%$ .125W TF TC= $0 \pm 100$	02995	SFR25H
R24	0757-0280	1	RESISTOR 1K $\pm 1\%$ .125W TF TC= $0 \pm 100$	02995	SFR25H
R25	0757-0401	1	RESISTOR 100 $\pm 1\%$ .125W TF TC= $0 \pm 100$	02995	SFR25H
R26	0757-0401	1	RESISTOR 100 $\pm 1\%$ .125W TF TC= $0 \pm 100$	02995	SFR25H
R27	0757-0401	1	RESISTOR 100 $\pm 1\%$ .125W TF TC= $0 \pm 100$	02995	SFR25H
R28	0757-0401	1	RESISTOR 100 $\pm 1\%$ .125W TF TC= $0 \pm 100$	02995	SFR25H
R29	0757-0346	1	RESISTOR 10 $\pm 1\%$ .125W TF TC= $0 \pm 100$	05524	CMF-55-1, T-1
R30	0698-3444	1	RESISTOR 316 $\pm 1\%$ .125W TF TC= $0 \pm 100$	02995	SFR25H
R31	0698-3444	1	RESISTOR 316 $\pm 1\%$ .125W TF TC= $0 \pm 100$	02995	SFR25H
R32	0698-3444	1	RESISTOR 316 $\pm 1\%$ .125W TF TC= $0 \pm 100$	02995	SFR25H
R33	0698-3444	1	RESISTOR 316 $\pm 1\%$ .125W TF TC= $0 \pm 100$	02995	SFR25H
R34	0698-3444	1	RESISTOR 316 $\pm 1\%$ .125W TF TC= $0 \pm 100$	02995	SFR25H
R35	2100-3755	1	RESISTOR-TRMR 50 10% TKF SIDE-ADJ 17-TRN	04568	67XR
R36	2100-3755	1	RESISTOR-TRMR 50 10% TKF SIDE-ADJ 17-TRN	04568	67XR
R37	0757-0442	1	RESISTOR 10K $\pm 1\%$ .125W TF TC= $0 \pm 100$	02995	SFR25H
R38	2100-3755	1	RESISTOR-TRMR 50 10% TKF SIDE-ADJ 17-TRN	04568	67XR
R39	2100-3755	1	RESISTOR-TRMR 50 10% TKF SIDE-ADJ 17-TRN	04568	67XR
TP1	0360-0535	1	CONNECTOR-SGL CONT TML-TS-PT	04055	
TP2	0360-0535	1	CONNECTOR-SGL CONT TML-TS-PT	04055	
TP3	0360-0535	1	CONNECTOR-SGL CONT TML-TS-PT	04055	
TP4	0360-0535	1	CONNECTOR-SGL CONT TML-TS-PT	04055	
TP5	0360-0535	1	CONNECTOR-SGL CONT TML-TS-PT	04055	
TP6	0360-0535	1	CONNECTOR-SGL CONT TML-TS-PT	04055	
VR1	1902-0958	1	DIODE-ZNR 10V 5% DO-35 PD= $.4W$ TC= $+.075\%$	02037	
VR2	1902-0953	1	DIODE-ZNR 6.2V 5% DO-35 PD= $.4W$ TC= $+.053\%$	02037	SZ30035-11RL
VR3	1902-3224	1	DIODE-ZNR 17.8V 5% DO-35 PD= $.4W$	02037	
VR4	1902-3224	1	DIODE-ZNR 17.8V 5% DO-35 PD= $.4W$	02037	
VR5	1902-3290	1	DIODE-ZNR 31.6V 5% DO-35 PD= $.4W$	02037	
VR6	1902-3182	1	DIODE-ZNR 12.1V 5% DO-35 PD= $.4W$	02037	
VR7	1902-3182	1	DIODE-ZNR 12.1V 5% DO-35 PD= $.4W$	02037	
X1	1251-2313	14	CONNECTOR-SGL CONT SKT .04-IN-BSC-SZ RND	01380	3-332070-5

Table 6-2. Replaceable Parts

Ref Desig	HP Part Number	Qty	Description	Mfr Code	Mfr Part Number
A6	08349-60037	1	BD AY-MTHR	28480	08349-60075
J1	1251-8494	1	CONN-POST TYPE .100-PIN-SPCG 24-CONT	01380	534978-4
J2	1251-8494	1	CONN-POST TYPE .100-PIN-SPCG 24-CONT	01380	534978-4
J3	1252-0638	1	CONN-POST TYPE .100-PIN-SPCG 10-CONT	01380	103168-3
J4	1251-8494	1	CONN-POST TYPE .100-PIN-SPCG 24-CONT	01380	534978-4
J5	1252-0208	1	CONN-POST TYPE .100-PIN-SPCG 24-CONT	01380	1-103166-0
J6	1200-1205	1	SOCKET-IC-DIP 16-CONT DIP DIP-SLDR	01380	2-641610-2
MP2	0380-1258	5	STANDOFF-PRESS-IN 16.00 MM LG; M 3.0 X	03981	KFSE-M3-16
R1	0757-0442	1	RESISTOR 10K $\pm$ 1% .125W TF TC=0 $\pm$ 100	02995	SFR25H
VR1	1902-1429	1	DIODE-ZNR 5.11V 2% DO-35 PD= .4W	02037	



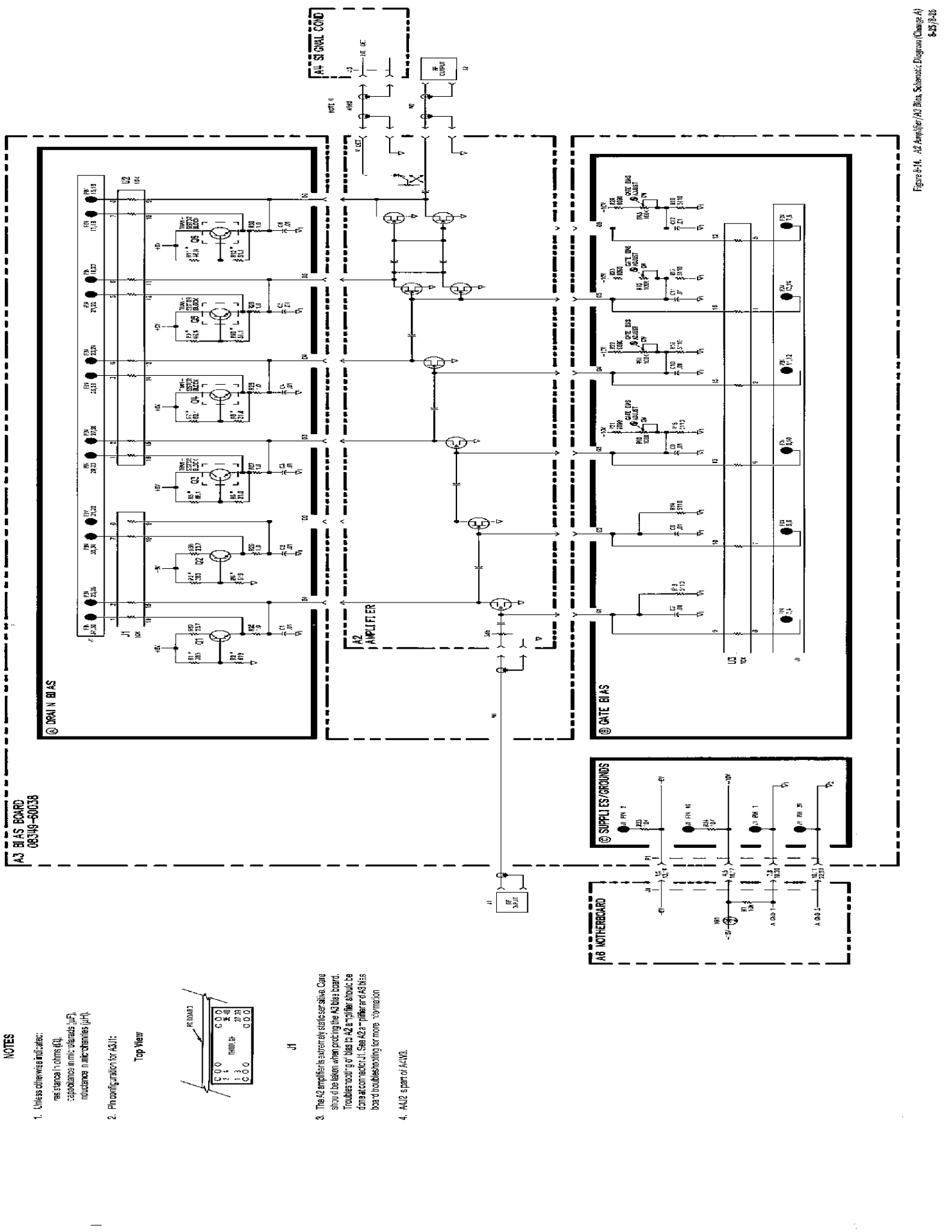

**NOTES**

1. Unless otherwise indicated:  
 resistances in ohms (Ω),  
 capacitance in microfarads (μF),  
 inductance in microhenries (μH).

2. Pin configuration for A3J1:

Top View

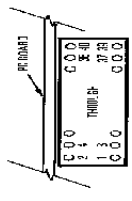

A3J1

3. The A2 amplifier is extremely sensitive. Care should be taken when probing the A3 bias board. Troubleshooting of bias to A2 amplifier should be done at connector J1. See A2 amplifier and A3 bias board troubleshooting for more information.

4. A4J2 is part of A4-NG.

Figure 6-14. A2 Amplifier/A3 Bias Submodule Diagram (Change A)  
 6-25 (2-82)

## **A6 MOTHERBOARD**

The A6 motherboard interconnects all the major assemblies in the HP 8349B. Refer to the Overall Block Diagram for a diagram of the connections between the motherboard and the rest of the instrument.

### **MODULE/SYNTHESIZER INTERFACE INTERCONNECTION DESCRIPTION**

The Module/Synthesizer Interface provides the necessary power supply voltages and control lines when using a millimeter source module during millimeter-wave applications.

The majority of control lines (both analog and digital) are transparent to the HP 8349B. The lines pass directly through the amplifier from the module interface connector J6 to the synthesizer interface connector J7. See Figure 8-25.

The module interface connector (J6) provides the necessary power supply operating voltages ( $\pm 15$  V + 8 V, and +5 V) to the source module for both analog and digital circuits. These voltages are supplied from the A5 Regulator assembly in the HP 8349B.

An EXT LEV -- ALC signal from the source module is routed to the HP 8349B through the coaxial cable in the center of the Module Interface connector J6. The signal is then routed through the A4 Signal Conditioning Board to one of two places depending on what type of RF source is connected to the amplifier. If a synthesizer is connected to the Synthesizer Interface connector the EXT LEV (Logged ALC Signal) is routed directly to the center coaxial cable in the Synthesizer Interface connector J7. This LEV OUT signal goes to the synthesizer for processing to provide leveled output power at the RF output of the source module. If a synthesizer is not being used, the EXT LEV signal is processed through an exponential circuit on the A4 Signal Conditioning Board to provide a linear output signal (DET OUT) on the rear panel (BNC connector J5) of the HP 8349B.

The control lines for the EXT LEV and LEV OUT signals are provided in the connectors J6 and J7. Module sense is normally pulled down. When the source module is connected to J6, module sense becomes high de-energizing a relay on the A4 assembly for signal routing. Source sense is a normally pulled up signal. When the RF source connection is made, the line is pulled low and de-energizes a relay on the Q4 assembly for routing. See the service section for the A4 Signal Conditioning Board concerning circuit details.

### **INTERFACE TROUBLESHOOTING**

Check proper supply voltages on the Module Interface connector J6. Continuity checks on the remaining control lines can be made with a DVM from J6 to J7.

The ALC signals and routing can be checked by connecting a source module or synthesizer to the HP 8349B to ensure correct signal routing. If a module or synthesizer are not available, the EXT LEV signal can be checked by connecting the module sense control line (J6-11) to a TTL high level (J6-7). The LEV OUT signal can be checked by connecting the source sense control line (J7-11) to a TTL low level (J7-17). A continuity check can be made with both control lines activated. If continuity is not made, refer to the service section on the A4 Signal Conditioning Board troubleshooting.

A6

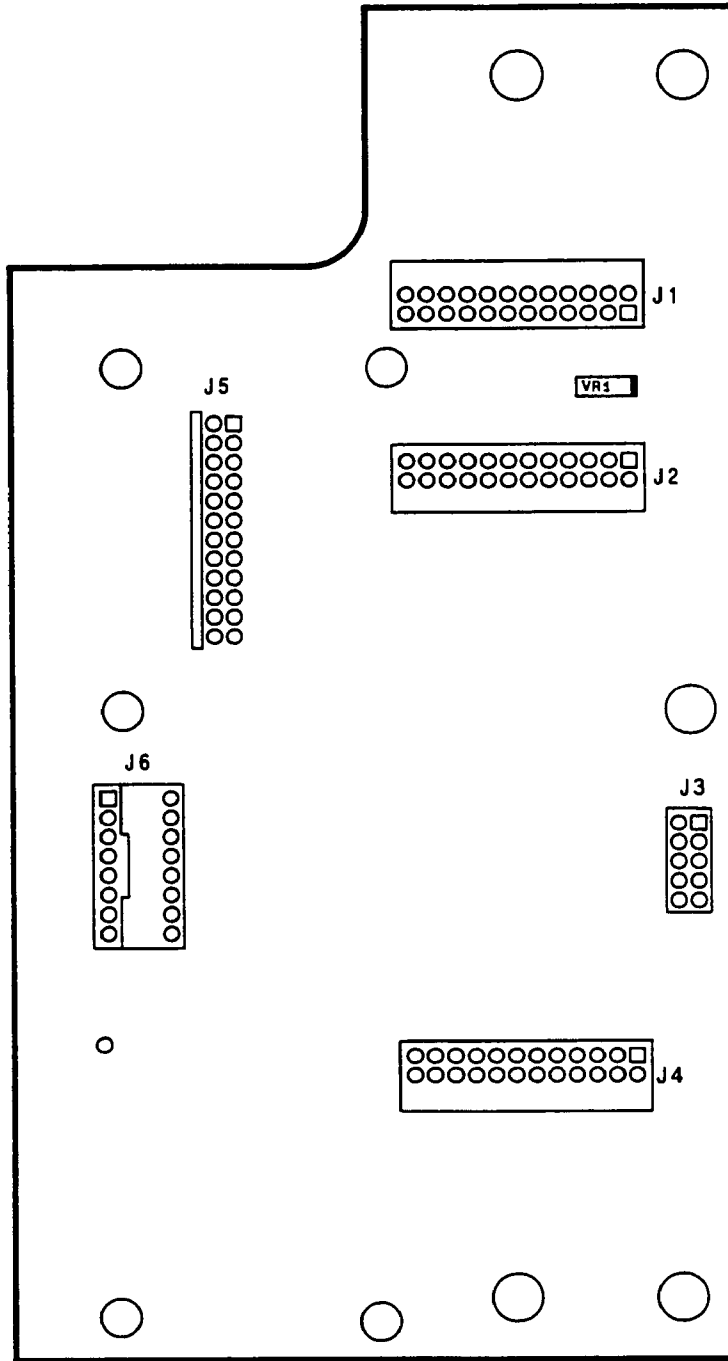

Figure 8-24. A6 Motherboard, Component Locations Diagram

## **CHANGE B**

The following changes apply directly to the instruments with the serial prefix opposite this lettered change in Table 7-1 and should be used when servicing them.

**Replace the existing manual pages with the following pages:**

6-9  
6-10  
6-11  
6-14  
8-27  
8-34  
8-35/8-36

# **HP 8349B MICROWAVE AMPLIFIER**

## **SERIAL NUMBERS**

This manual applies directly to HP 8349B Microwave Amplifier having serial numbers prefixed 2627A.

For additional information about serial numbers, refer to INSTRUMENTS COVERED BY MANUAL in Section 1.

©Copyright                      HEWLETT-PACKARD COMPANY                      1985  
1400 FOUNTAINGROVE PARKWAY, SANTA ROSA, CA 95403 U.S.A.

MANUAL PART NO. 08349-90017

Printed: APRIL 1991



Change B

## **CERTIFICATION**

*Hewlett-Packard Company certifies that this product met its published specifications at the time of shipment from the factory. Hewlett-Packard further certifies that its calibration measurements are traceable to the United States National Institute of Standards and Technology (NIST, formerly NBS), to the extent allowed by the Institute's calibration facility, and to the calibration facilities of other International Standards Organization members.*

## **WARRANTY**

This Hewlett-Packard instrument product is warranted against defects in material and workmanship for a period of one year from date of delivery. During the warranty period, Hewlett-Packard Company will, at its option, either repair or replace products which prove to be defective.

For warranty service or repair, this product must be returned to a service facility designated by HP. Buyer shall prepay shipping charges to HP and HP shall pay shipping charges to return the product to Buyer. However, Buyer shall pay all shipping charges, duties, and taxes for products returned to HP from another country.

HP warrants that its software and firmware designated by HP for use with an instrument will execute its programming instructions when properly installed on that instrument. HP does not warrant that the operation of the instrument, or software, or firmware will be uninterrupted or error free.

### **LIMITATION OF WARRANTY**

The foregoing warranty shall not apply to defects resulting from improper or inadequate maintenance by Buyer, Buyer-supplied software or interfacing, unauthorized modification or misuse, operation outside of the environmental specifications for the product, or improper site preparation or maintenance.

NO OTHER WARRANTY IS EXPRESSED OR IMPLIED. HP SPECIFICALLY DISCLAIMS THE IMPLIED WARRANTIES OF MERCHANTABILITY AND FITNESS FOR A PARTICULAR PURPOSE.

### **EXCLUSIVE REMEDIES**

THE REMEDIES PROVIDED HEREIN ARE BUYER'S SOLE AND EXCLUSIVE REMEDIES. HP SHALL NOT BE LIABLE FOR ANY DIRECT, INDIRECT, SPECIAL, INCIDENTAL, OR CONSEQUENTIAL DAMAGES, WHETHER BASED ON CONTRACT, TORT, OR ANY OTHER LEGAL THEORY.

## **ASSISTANCE**

*Product maintenance agreements and other customer assistance agreements are available for Hewlett-Packard products.*

*For any assistance, contact your nearest Hewlett-Packard Sales and Service Office. Addresses are provided at the back of this manual.*

Table 6-2. Replaceable Parts

Ref Desig	HP Part Number	Qty	Description	Mfr Code	Mfr Part Number
A4	08349-60071	1	BD AY-SIG CONDT	28480	08349-60079
C1	0160-4535	1	CAP-FXD 1uF ± 10% 50 V CER X7R	09939	RPE113-130X7R105K50V
C2	0160-4535	1	CAP-FXD 1uF ± 10% 50 V CER X7R	09939	RPE113-130X7R105K50V
C3	0160-4535	1	CAP-FXD 1uF ± 10% 50 V CER X7R	09939	RPE113-130X7R105K50V
C4	0160-4535	1	CAP-FXD 1uF ± 10% 50 V CER X7R	09939	RPE113-130X7R105K50V
C5	0160-4535	1	CAP-FXD 1uF ± 10% 50 V CER X7R	09939	RPE113-130X7R105K50V
C6	0160-4535	1	CAP-FXD 1uF ± 10% 50 V CER X7R	09939	RPE113-130X7R105K50V
C7	0160-4535	1	CAP-FXD 1uF ± 10% 50 V CER X7R	09939	RPE113-130X7R105K50V
C8	0160-0575	1	CAP-FXD 0.047uF ± 20% 50 V CER X7R	02010	SR205C473MAAH
C9	0160-0575	1	CAP-FXD 0.047uF ± 20% 50 V CER X7R	02010	SR205C473MAAH
C10	0160-4799	1	CAP-FXD 2.2pF ± 11.36% 100 V CER COG	02010	MA101A2R2CAAH
C11	0160-0575	1	CAP-FXD 0.047uF ± 20% 50 V CER X7R	02010	SR205C473MAAH
C12	0160-0575	1	CAP-FXD 0.047uF ± 20% 50 V CER X7R	02010	SR205C473MAAH
C13	0160-4791	1	CAP-FXD 10pF ± 5% 100 V CER COG	02010	SA102A100JAAH
C14	0160-0575	1	CAP-FXD 0.047uF ± 20% 50 V CER X7R	02010	SR205C473MAAH
C15	0160-0575	1	CAP-FXD 0.047uF ± 20% 50 V CER X7R	02010	SR205C473MAAH
C16	0160-0575	1	CAP-FXD 0.047uF ± 20% 50 V CER X7R	02010	SR205C473MAAH
C17	0160-0575	1	CAP-FXD 0.047uF ± 20% 50 V CER X7R	02010	SR205C473MAAH
C18	0160-0575	1	CAP-FXD 0.047uF ± 20% 50 V CER X7R	02010	SR205C473MAAH
C19	0160-4822	1	CAP-FXD 1000pF ± 5% 100 V CER COG	02010	SA201A102JAAH
C20	0180-0116	1	CAP-FXD 6.8uF ± 10% 35 V TA	04200	150D685X9035B2-DYS
C21	0160-0575	1	CAP-FXD 0.047uF ± 20% 50 V CER X7R	02010	SR205C473MAAH
C22	0160-0575	1	CAP-FXD 0.047uF ± 20% 50 V CER X7R	02010	SR205C473MAAH
C23	0160-4799	1	CAP-FXD 2.2pF ± 11.36% 100 V CER COG	02010	MA101A2R2CAAH
C24	0160-0575	1	CAP-FXD 0.047uF ± 20% 50 V CER X7R	02010	SR205C473MAAH
C25	0160-0575	1	CAP-FXD 0.047uF ± 20% 50 V CER X7R	02010	SR205C473MAAH
C26	0160-0575	1	CAP-FXD 0.047uF ± 20% 50 V CER X7R	02010	SR205C473MAAH
C27	0160-0575	1	CAP-FXD 0.047uF ± 20% 50 V CER X7R	02010	SR205C473MAAH
C28	0160-0575	1	CAP-FXD 0.047uF ± 20% 50 V CER X7R	02010	SR205C473MAAH
C29	0160-0575	1	CAP-FXD 0.047uF ± 20% 50 V CER X7R	02010	SR205C473MAAH
C30	0160-4653	1	CAP-FXD 0.1uF ± 5% 100 V POLYP-MET	05176	HEW-505
C31	0180-0116	1	CAP-FXD 6.8uF ± 10% 35 V TA	04200	150D685X9035B2-DYS
C32	0180-0116	1	CAP-FXD 6.8uF ± 10% 35 V TA	04200	150D685X9035B2-DYS
C33	0160-4805	1	CAP-FXD 47pF ± 5% 100 V CER COG	02010	SA102A470JAAH
C34	0160-0575	1	CAP-FXD 0.047uF ± 20% 50 V CER X7R	02010	SR205C473MAAH
C35	0160-0575	1	CAP-FXD 0.047uF ± 20% 50 V CER X7R	02010	SR205C473MAAH
C36	0160-0575	1	CAP-FXD 0.047uF ± 20% 50 V CER X7R	02010	SR205C473MAAH
C37	0160-0575	1	CAP-FXD 0.047uF ± 20% 50 V CER X7R	02010	SR205C473MAAH
C39	0160-4787	1	CAP-FXD 22pF ± 5% 100 V CER COG	02010	SA102A220JAAH
CR1	1901-0376	1	DIODE-GEN PRP 35V 50MA DO-35	11946	S303
CR2	1901-0050	1	DIODE-SWITCHING 80V 200MA 2NS DO-35	03334	BAV10 SELECTED
CR3	1901-0050	1	DIODE-SWITCHING 80V 200MA 2NS DO-35	03334	BAV10 SELECTED
CR4	1901-0050	1	DIODE-SWITCHING 80V 200MA 2NS DO-35	03334	BAV10 SELECTED
CR5	1901-0050	1	DIODE-SWITCHING 80V 200MA 2NS DO-35	03334	BAV10 SELECTED
CR6	1901-0050	1	DIODE-SWITCHING 80V 200MA 2NS DO-35	03334	BAV10 SELECTED
CR7	1901-0050	1	DIODE-SWITCHING 80V 200MA 2NS DO-35	03334	BAV10 SELECTED
CR8	1901-0050	1	DIODE-SWITCHING 80V 200MA 2NS DO-35	03334	BAV10 SELECTED
CR9	1901-0050	1	DIODE-SWITCHING 80V 200MA 2NS DO-35	03334	BAV10 SELECTED
CR10	1901-0050	1	DIODE-SWITCHING 80V 200MA 2NS DO-35	03334	BAV10 SELECTED
CR11	1901-0050	1	DIODE-SWITCHING 80V 200MA 2NS DO-35	03334	BAV10 SELECTED
CR12	1901-0050	1	DIODE-SWITCHING 80V 200MA 2NS DO-35	03334	BAV10 SELECTED
CR13	1901-0050	1	DIODE-SWITCHING 80V 200MA 2NS DO-35	03334	BAV10 SELECTED
CR14	1901-0050	1	DIODE-SWITCHING 80V 200MA 2NS DO-35	03334	BAV10 SELECTED
CR15	1901-0050	1	DIODE-SWITCHING 80V 200MA 2NS DO-35	03334	BAV10 SELECTED
CR16	1901-0050	1	DIODE-SWITCHING 80V 200MA 2NS DO-35	03334	BAV10 SELECTED
J1	1252-0937	1	CONN-POST TYPE .100-PIN-SPCG 8-CONT	01380	103166-2
J2	1252-0933	1	CONN-POST TYPE .100-PIN-SPCG 22-CONT	01380	103166-9
J4	1250-0257	1	CONNECTOR-RF SMB M PC-W-STDFS 50-OHM	05769	051-351-0049-226
J5	1250-0257	1	CONNECTOR-RF SMB M PC-W-STDFS 50-OHM	05769	051-351-0049-226
J6	1250-0257	1	CONNECTOR-RF SMB M PC-W-STDFS 50-OHM	05769	051-351-0049-226
K1	0490-1409	1	RELAY 2C 5VDC-COIL 2A 250VAC	01850	DS2E-S-DC5V-H121
K2	0490-1409	1	RELAY 2C 5VDC-COIL 2A 250VAC	01850	DS2E-S-DC5V-H121
L1	9100-3562	1	INDUCTOR RF-CH-MLD 4.7UH ± 5%	03273	15M471J
L2	9100-3562	1	INDUCTOR RF-CH-MLD 4.7UH ± 5%	03273	15M471J
L3	9100-3562	1	INDUCTOR RF-CH-MLD 4.7UH ± 5%	03273	15M471J
L4	9100-3562	1	INDUCTOR RF-CH-MLD 4.7UH ± 5%	03273	15M471J
L5	9100-3562	1	INDUCTOR RF-CH-MLD 4.7UH ± 5%	03273	15M471J
L6	9100-3562	1	INDUCTOR RF-CH-MLD 4.7UH ± 5%	03273	15M471J
MP2	1200-0173	3	INSULATOR-XSTR DAP-GL	02210	A-10001 DAP
P1	1251-8603	1	CONN-POST TYPE .100-PIN-SPCG 24-CONT	01380	1-534204-1

Table 6-2. Replaceable Parts

Ref Desig	HP Part Number	Qty	Description	Mfr Code	Mfr Part Number
Q1	1854-0295	1	TRANSISTOR-DUAL NPN TO-78 PD=400MW	02037	
Q2	1854-0295	1	TRANSISTOR-DUAL NPN TO-78 PD=400MW	02037	
Q3	1855-0525	1	TRANSISTOR MOSFET N-CHAN E-MODE SI	02883	VN0300M
Q4	1855-0525	1	TRANSISTOR MOSFET N-CHAN E-MODE SI	02883	VN0300M
Q5	1855-0386	1	TRANSISTOR J-FET 2N4392 N-CHAN D-MODE	02037	2N4392
Q6	1853-0316	1	TRANSISTOR-DUAL PNP PD=500MW	13127	LS352
Q7	1855-0646	1	TRANSISTOR MOSFET N-CHAN E-MODE TO-39 SI	03038	IRFF131
Q8	1855-0646	1	TRANSISTOR MOSFET N-CHAN E-MODE TO-39 SI	03038	IRFF131
Q9	1853-0075	1	TRANSISTOR-DUAL PNP PD=400MW	02037	
Q10	1853-0281	1	TRANSISTOR PNP 2N2907A SI TO-18 PD=400MW	02037	2N2907A
Q11	1854-0295	1	TRANSISTOR-DUAL NPN TO-78 PD=400MW	02037	
R2	0757-1094	1	RESISTOR 1.47K ±1% .125W TF TC=0±100	02995	SFR25H
R3	0757-0346	1	RESISTOR 10 ±1% .125W TF TC=0±100	05524	CMF-55-1, T-1
R4	0698-8827	1	RESISTOR 1M ±1% .125W TF TC=0±100	02995	SFR25H
R5	0698-6782	1	RESISTOR 250 ±0.1% .125W TF TC=0±25	02995	5033R
R6	0698-6362	1	RESISTOR 1K ±0.1% .125W TF TC=0±25	02995	5033R
R7	0757-0280	1	RESISTOR 1K ±1% .125W TF TC=0±100	02995	SFR25H
R8	0698-0083	1	RESISTOR 1.96K ±1% .125W TF TC=0±100	02995	SFR25H
R9	0757-0438	1	RESISTOR 5.11K ±1% .125W TF TC=0±100	02995	SFR25H
R10	0757-0438	1	RESISTOR 5.11K ±1% .125W TF TC=0±100	02995	SFR25H
R11	0698-3153	1	RESISTOR 3K ±0.1% .125W TF TC=0±25	02995	5033R
R12	0698-8820	1	RESISTOR 4.64 ±1% .125W TF TC=0±100	05524	CMF-55-1
R13	0757-0346	1	RESISTOR 10 ±1% .125W TF TC=0±100	05524	CMF-55-1, T-1
R14	2100-3611	1	RESISTOR-TRMR 50K 10% TKF SIDE-ADJ	04568	67XR
R15	0757-0465	1	RESISTOR 100K ±1% .125W TF TC=0±100	02995	SFR25H
R16	0698-3153	1	RESISTOR 3.83K ±1% .125W TF TC=0±100	02995	SFR25H
R17	0757-0465	1	RESISTOR 100K ±1% .125W TF TC=0±100	02995	SFR25H
R18	0698-3159	1	RESISTOR 26.1K ±1% .125W TF TC=0±100	02995	SFR25H
R19	0757-0280	1	RESISTOR 1K ±1% .125W TF TC=0±100	02995	SFR25H
R20	0757-0467	1	RESISTOR 121K ±1% .125W TF TC=0±100	02995	SFR25H
R21	2100-3753	1	RESISTOR-TRMR 200K 10% TKF SIDE-ADJ	04568	67XR
R22	0757-0444	1	RESISTOR 12.1K ±1% .125W TF TC=0±100	02995	SFR25H
R23	2100-3611	1	RESISTOR-TRMR 50K 10% TKF SIDE-ADJ	04568	67XR
R24	0698-3155	1	RESISTOR 4.64K ±1% .125W TF TC=0±100	28480	0698-4155
R25	0757-0439	1	RESISTOR 6.81K ±1% .125W TF TC=0±100	02995	SFR25H
R26	0698-6625	1	RESISTOR 6K ±0.1% .125W TF TC=0±25	02995	5033R
R27	0698-6360	1	RESISTOR 10K ±0.1% .125W TF TC=0±25	02995	5033R
R28	0698-6360	1	RESISTOR 10K ±0.1% .125W TF TC=0±25	02995	5033R
R29	0757-0280	1	RESISTOR 1K ±1% .125W TF TC=0±100	02995	SFR25H
R30	0757-0401	1	RESISTOR 100 ±1% .125W TF TC=0±100	02995	SFR25H
R31	0757-0280	1	RESISTOR 1K ±1% .125W TF TC=0±100	28480	0757-0280
R32	0698-3449	1	RESISTOR 28.7K ±1% .125W TF TC=0±100	02995	SFR25H
R33	0757-0428	1	RESISTOR 1.62K ±1% .125W TF TC=0±100	02995	SFR25H
R34	2100-3732	1	RESISTOR-TRMR 500 10% TKF SIDE-ADJ	04568	67XR
R35	0757-0280	1	RESISTOR 1K ±1% .125W TF TC=0±100	02995	SFR25H
R36	0698-6364	1	RESISTOR 50 ±0.1% .125W TF TC=0±25	02995	5033R
R37	0757-0438	1	RESISTOR 5.11K ±1% .125W TF TC=0±100	02995	SFR25H
R38	0757-0280	1	RESISTOR 1K ±1% .125W TF TC=0±100	02995	SFR25H
R39	0698-3452	1	RESISTOR 147K ±1% .125W TF TC=0±100	02995	SFR25H
R40	0698-6625	1	RESISTOR 6K ±0.1% .125W TF TC=0±25	02995	5033R
R41	0698-3153	1	RESISTOR 3.83K ±1% .125W TF TC=0±100	02995	SFR25H
R42	0698-3154	1	RESISTOR 4.22K ±1% .125W TF TC=0±100	02995	SFR25H
R43	0698-6323	1	RESISTOR 100 ±0.1% .125W TF TC=0±25	05524	CMF-55-1, T-9
R44	0698-6377	1	RESISTOR 200 ±0.1% .125W TF TC=0±25	05524	CMF-55-1, T-9
R45	0698-6346	1	RESISTOR 300 ±0.1% .125W TF TC=0±25	02995	5033R
R46	0698-6355	1	RESISTOR 400 ±0.1% .125W TF TC=0±25	02995	5033R
R47	0698-6317	1	RESISTOR 500 ±0.1% .125W TF TC=0±25	05524	CMF-55-1, T-9
R48	0757-1100	1	RESISTOR 600 ±1% .125W TF TC=0±100	02995	SFR25H
R49	0698-4461	1	RESISTOR 698 ±1% .125W TF TC=0±100	05524	CMF-55-1, T-1
R50	0757-0421	1	RESISTOR 825 ±1% .125W TF TC=0±100	02995	SFR25H
R51	0757-0428	1	RESISTOR 1.62K ±1% .125W TF TC=0±100	02995	SFR25H
R52	0757-0280	1	RESISTOR 1K ±1% .125W TF TC=0±100	02995	SFR25H
R53	0757-0280	1	RESISTOR 1K ±1% .125W TF TC=0±100	02995	SFR25H
R54	0757-0280	1	RESISTOR 1K ±1% .125W TF TC=0±100	02995	SFR25H
R55	0757-0280	1	RESISTOR 1K ±1% .125W TF TC=0±100	02995	SFR25H
R56	0757-0280	1	RESISTOR 1K ±1% .125W TF TC=0±100	02995	SFR25H
R57	0757-0280	1	RESISTOR 1K ±1% .125W TF TC=0±100	02995	SFR25H
R58	0757-0280	1	RESISTOR 1K ±1% .125W TF TC=0±100	02995	SFR25H
R59	0757-0280	1	RESISTOR 1K ±1% .125W TF TC=0±100	02995	SFR25H
R60	2100-3611	1	RESISTOR-TRMR 50K 10% TKF SIDE-ADJ	04568	67XR
R61	2100-3611	1	RESISTOR-TRMR 50K 10% TKF SIDE-ADJ	04568	67XR
R62	2100-3611	1	RESISTOR-TRMR 50K 10% TKF SIDE-ADJ	04568	67XR
R63	2100-3611	1	RESISTOR-TRMR 50K 10% TKF SIDE-ADJ	04568	67XR



Table 6-2. Replaceable Parts

Ref Desig	HP Part Number	Qty	Description	Mfr Code	Mfr Part Number
R64	2100-3611	1	RESISTOR-TRMR 50K 10% TKF SIDE-ADJ	04568	67XR
R65	2100-3611	1	RESISTOR-TRMR 50K 10% TKF SIDE-ADJ	04568	67XR
R66	2100-3611	1	RESISTOR-TRMR 50K 10% TKF SIDE-ADJ	04568	67XR
R67	2100-3611	1	RESISTOR-TRMR 50K 10% TKF SIDE-ADJ	04568	67XR
R68	0757-0442	1	RESISTOR 10K $\pm 1\%$ .125W TF TC=0 $\pm 100$	02995	SFR25H
R69	0757-0442	1	RESISTOR 10K $\pm 1\%$ .125W TF TC=0 $\pm 100$	02995	SFR25H
R70	0757-0442	1	RESISTOR 10K $\pm 1\%$ .125W TF TC=0 $\pm 100$	02995	SFR25H
R71	0757-0442	1	RESISTOR 10K $\pm 1\%$ .125W TF TC=0 $\pm 100$	02995	SFR25H
R72	0757-0280	1	RESISTOR 1K $\pm 1\%$ .125W TF TC=0 $\pm 100$	02995	SFR25H
R73	0698-3153	1	RESISTOR 3.83K $\pm 1\%$ .125W TF TC=0 $\pm 100$	02995	SFR25H
R74	0757-0442	1	RESISTOR 10K $\pm 1\%$ .125W TF TC=0 $\pm 100$	02995	SFR25H
R75	0757-0438	1	RESISTOR 5.11K $\pm 1\%$ .125W TF TC=0 $\pm 100$	02995	SFR25H
R76	0757-0442	1	RESISTOR 10K $\pm 1\%$ .125W TF TC=0 $\pm 100$	02995	SFR25H
R77	0757-0280	1	RESISTOR 1K $\pm 1\%$ .125W TF TC=0 $\pm 100$	02995	SFR25H
R78	0683-2265	1	RESISTOR 22M $\pm 5\%$ .25W CC TC=-900/+1200	01607	CB2265
R79	2100-0545	1	RESISTOR-TRMR 1K 10% TKF SIDE-ADJ 17-TRN	04568	67XR
R80	0698-8827	1	RESISTOR 1M $\pm 1\%$ .125W TF TC=0 $\pm 100$	02995	SFR25H
R81	2100-3611	1	RESISTOR-TRMR 50K 10% TKF SIDE-ADJ	04568	67XR
R82	0757-0346	1	RESISTOR 10 $\pm 1\%$ .125W TF TC=0 $\pm 100$	05524	CMF-55-1, T-1
R83	0757-0465	1	RESISTOR 100K $\pm 1\%$ .125W TF TC=0 $\pm 100$	02995	SFR25H
R84	0757-0465	1	RESISTOR 100K $\pm 1\%$ .125W TF TC=0 $\pm 100$	02995	SFR25H
R85	0757-0280	1	RESISTOR 1K $\pm 1\%$ .125W TF TC=0 $\pm 100$	02995	SFR25H
R86	0698-3456	1	RESISTOR 287K $\pm 1\%$ .125W TF TC=0 $\pm 100$	02995	SFR25H
R87	0698-6624	1	RESISTOR 2K $\pm 0.1\%$ .125W TF TC=0 $\pm 25$	02995	5033R
R88	0757-0199	1	RESISTOR 21.5K $\pm 1\%$ .125W TF TC=0 $\pm 100$	02995	SFR25H
R89	2100-0670	1	RESISTOR-TRMR 10K 10% TKF SIDE-ADJ	04568	67XR
R90	0757-0401	1	RESISTOR 100 $\pm 1\%$ .125W TF TC=0 $\pm 100$	02995	SFR25H
R91	0757-0401	1	RESISTOR 100 $\pm 1\%$ .125W TF TC=0 $\pm 100$	02995	SFR25H
R93	0757-0401	1	RESISTOR 100 $\pm 1\%$ .125W TF TC=0 $\pm 100$	02995	SFR25H
R94	0698-3136	1	RESISTOR 17.8K $\pm 1\%$ .125W TF TC=0 $\pm 100$	02995	SFR25H
R95	0757-0280	1	RESISTOR 1K $\pm 1\%$ .125W TF TC=0 $\pm 100$	02995	SFR25H
R96	0757-0280	1	RESISTOR 1K $\pm 1\%$ .125W TF TC=0 $\pm 100$	02995	SFR25H
R97	0698-6364	1	RESISTOR 50 $\pm 0.1\%$ .125W TF TC=0 $\pm 25$	02995	5033R
R98	0757-0346	1	RESISTOR 10 $\pm 1\%$ .125W TF TC=0 $\pm 100$	05524	CMF-55-1, T-1
R99	0757-0441	1	RESISTOR 8.25K $\pm 1\%$ .125W TF TC=0 $\pm 100$	02995	SFR25H
R100	0698-3160	1	RESISTOR 31.6K $\pm 1\%$ .125W TF TC=0 $\pm 100$	02995	SFR25H
R101	0757-0289	1	RESISTOR 13.3K $\pm 1\%$ .125W TF TC=0 $\pm 100$	02995	SFR25H
R102	0757-0280	1	RESISTOR 1K $\pm 1\%$ .125W TF TC=0 $\pm 100$	02995	SFR25H
R103	0757-0289	1	RESISTOR 13.3K $\pm 1\%$ .125W TF TC=0 $\pm 100$	02995	SFR25H
R104	0757-0401	1	RESISTOR 100 $\pm 1\%$ .125W TF TC=0 $\pm 100$	02995	SFR25H
R105	0757-0401	1	RESISTOR 100 $\pm 1\%$ .125W TF TC=0 $\pm 100$	02995	SFR25H
R106	0757-0398	1	RESISTOR 75 $\pm 1\%$ .125W TF TC=0 $\pm 100$	02995	SFR25H
R107	0757-0398	1	RESISTOR 75 $\pm 1\%$ .125W TF TC=0 $\pm 100$	02995	SFR25H
R108	0757-0401	1	RESISTOR 100 $\pm 1\%$ .125W TF TC=0 $\pm 100$	02995	SFR25H
R109	0757-0280	1	RESISTOR 1K $\pm 1\%$ .125W TF TC=0 $\pm 100$	02995	SFR25H
RT1	0837-0345	1	THERMISTOR DISC 50K-OHM TC=-4.3%/C-DEG	05524	8M5002-1
RT2	0837-0342	1	THERMISTOR TUB WITH AXL LEADS 100-OHM	06784	1K101J
RT3	0837-0342	1	THERMISTOR TUB WITH AXL LEADS 100-OHM	06784	1K101J
TP1	0360-0535	1	CONNECTOR-SGL CONT TML-TS-PT	04055	
TP2	0360-0535	1	CONNECTOR-SGL CONT TML-TS-PT	04055	
TP3	0360-0535	1	CONNECTOR-SGL CONT TML-TS-PT	04055	
TP4	0360-0535	1	CONNECTOR-SGL CONT TML-TS-PT	04055	
TP5	0360-0535	1	CONNECTOR-SGL CONT TML-TS-PT	04055	
TP6	0360-0535	1	CONNECTOR-SGL CONT TML-TS-PT	04055	
TP7	0360-0535	1	CONNECTOR-SGL CONT TML-TS-PT	04055	
TP8	0360-0535	1	CONNECTOR-SGL CONT TML-TS-PT	04055	
TP9	0360-0535	1	CONNECTOR-SGL CONT TML-TS-PT	04055	
U1	1826-0785	1	IC OP AMP LOW-BIAS-H-IMPED DUAL 8-DIP-C	02037	MC34002BU
U2	1858-0087	1	TRANSISTOR ARRAY 14-PIN PLSTC TO-116	02037	MPQ3904
U3	1858-0087	1	TRANSISTOR ARRAY 14-PIN PLSTC TO-116	02037	MPQ3904
U4	1826-0742	1	IC V RGLTR-V-REF-FXD 10V TO-5 PKG	03285	AD581J
U5	1826-0079	1	IC OP AMP WB 8-TO-99 PKG	03799	HA2-2625-5
U6	1826-0753	1	IC OP AMP LOW-BIAS-H-IMPED QUAD 14-DIP-P	1826-0753	TL074ACN
U7	1826-1049	1	IC OP AMP PRCN 8-DIP-C PKG	02180	OP-27GZ
U8	1826-0516	1	IC OP AMP WB 8-TO-99 PKG	02180	OP-17FJ
U9	1826-0601	1	IC OP AMP PRCN 8-TO-99 PKG	02180	OP-16FJ
U10	1826-0785	1	IC OP AMP LOW-BIAS-H-IMPED DUAL 8-DIP-C	02037	MC34002BU
U11	1826-0601	1	IC OP AMP PRCN 8-TO-99 PKG	02180	OP-16FJ
U12	1826-0601	1	IC OP AMP PRCN 8-TO-99 PKG	02180	OP-16FJ
U13	1826-0601	1	IC OP AMP PRCN 8-TO-99 PKG	02180	OP-16FJ
VR1	1902-1173	1	DIODE-ZNR 1N4104 10V 5% PD=.5W IR=1UA	02037	
W3	08349-60068	1	W3 CABLE ASSEMBLY	28480	08349-60068

Table 6-2. Replaceable Parts

Ref Desig	HP Part Number	Qty	Description	Mfr Code	Mfr Part Number
A5	08349-60040	1	BD AY-REGULATOR	28480	08349-60040
C1	0180-3394	1	CAP-FXD +50% -10% 25 V AL-ELCTLT	00493	SL25P103T30X51LL
C2	0180-3132	1	CAP-FXD 4700uF ±20% 35 V AL-ELCTLT	00493	SM35VP472M25X40
C3	0180-3395	1	CAP-FXD 1000uF ±20% 200 V AL-ELCTLT	00493	KM200VR102M35X50
C4	0180-3395	1	CAP-FXD 1000uF ±20% 200 V AL-ELCTLT	00493	KM200VR102M35X50
C5	0180-0291	1	CAP-FXD 1uF ±10% 35 V TA	04200	150D105X9035A2-DYS
C6	0180-0291	1	CAP-FXD 1uF ±10% 35 V TA	04200	150D105X9035A2-DYS
C7	0180-0291	1	CAP-FXD 1uF ±10% 35 V TA	04200	150D105X9035A2-DYS
C8	0180-0291	1	CAP-FXD 1uF ±10% 35 V TA	04200	150D105X9035A2-DYS
C9	0180-0230	1	CAP-FXD 1uF ±20% 50 V TA	04200	150D105X0050A2-DYS
C10	0180-0230	1	CAP-FXD 1uF ±20% 50 V TA	04200	150D105X0050A2-DYS
C11	0180-0291	1	CAP-FXD 1uF ±10% 35 V TA	04200	150D105X9035A2-DYS
C12	0180-0291	1	CAP-FXD 1uF ±10% 35 V TA	04200	150D105X9035A2-DYS
C15	0180-0116	1	CAP-FXD 6.8uF ±10% 35 V TA	04200	150D685X9035B2-DYS
C16	0180-0116	1	CAP-FXD 6.8uF ±10% 35 V TA	04200	150D685X9035B2-DYS
C17	0180-0116	1	CAP-FXD 6.8uF ±10% 35 V TA	04200	150D685X9035B2-DYS
C18	0180-0116	1	CAP-FXD 6.8uF ±10% 35 V TA	04200	150D685X9035B2-DYS
C20	0160-0168	1	CAP-FXD 0.1uF ±10% 200 V POLYE-FL	05176	HEW238T
C21	0160-0168	1	CAP-FXD 0.1uF ±10% 200 V POLYE-FL	05176	HEW238T
C22	0160-0168	1	CAP-FXD 0.1uF ±10% 200 V POLYE-FL	05176	HEW238T
C24	0160-4535	1	CAP-FXD 1uF ±10% 50 V CER X7R	09939	RPE113-130X7R105K50V
C25	0160-4535	1	CAP-FXD 1uF ±10% 50 V CER X7R	09939	RPE113-130X7R105K50V
C26	0160-4535	1	CAP-FXD 1uF ±10% 50 V CER X7R	09939	RPE113-130X7R105K50V
C27	0160-4535	1	CAP-FXD 1uF ±10% 50 V CER X7R	09939	RPE113-130X7R105K50V
C28	0180-3879	1	CAP-FXD 0.01uF ±20% 100 V CER X7R	02010	SR201C103MAAH
CR1	1901-0935	1	DIODE-PWR RECT 45V 8A	03038	
CR2	1901-0935	1	DIODE-PWR RECT 45V 8A	03038	
CR3	1901-0935	1	DIODE-PWR RECT 45V 8A	03038	
CR4	1901-0935	1	DIODE-PWR RECT 45V 8A	03038	
CR5	1901-0693	1	DIODE-PWR RECT 100V 1A 200NS DO-41	04504	1N4934
CR6	1901-0693	1	DIODE-PWR RECT 100V 1A 200NS DO-41	04504	1N4934
CR7	1901-0693	1	DIODE-PWR RECT 100V 1A 200NS DO-41	04504	1N4934
CR8	1901-0693	1	DIODE-PWR RECT 100V 1A 200NS DO-41	04504	1N4934
CR10	1901-0965	1	DIODE-PWR RECT 100V 3A 200NS	02037	
CR11	1901-0965	1	DIODE-PWR RECT 100V 3A 200NS	02037	
CR12	1901-0965	1	DIODE-PWR RECT 100V 3A 200NS	02037	
CR13	1901-0965	1	DIODE-PWR RECT 100V 3A 200NS	02037	
CR17	1901-0028	1	DIODE-PWR RECT 400V 750MA DO-29	02664	SS5117
CR18	1901-0028	1	DIODE-PWR RECT 400V 750MA DO-29	02664	SS5117
CR19	1901-0028	1	DIODE-PWR RECT 400V 750MA DO-29	02664	SS5117
CR20	1901-0028	1	DIODE-PWR RECT 400V 750MA DO-29	02664	SS5117
CR21	1901-0028	1	DIODE-PWR RECT 400V 750MA DO-29	02664	SS5117
CR22	1901-0028	1	DIODE-PWR RECT 400V 750MA DO-29	02664	SS5117
CR23	1901-0028	1	DIODE-PWR RECT 400V 750MA DO-29	02664	SS5117
CR24	1901-0028	1	DIODE-PWR RECT 400V 750MA DO-29	02664	SS5117
CR25	1901-0028	1	DIODE-PWR RECT 400V 750MA DO-29	02664	SS5117
CR26	1901-0028	1	DIODE-PWR RECT 400V 750MA DO-29	02664	SS5117
CR27	1901-0028	1	DIODE-PWR RECT 400V 750MA DO-29	02664	SS5117
CR28	1901-0028	1	DIODE-PWR RECT 400V 750MA DO-29	02664	SS5117
CR29	1901-0662	1	DIODE-PWR RECT 100V 6A	02037	MR751
DS1	1990-0485	1	LED-LAMP LUM-INT = 2MCD IF = 30MA-MAX BVR = 5V	01542	HLMP-1503
DS2	1990-0485	1	LED-LAMP LUM-INT = 2MCD IF = 30MA-MAX BVR = 5V	01542	HLMP-1503
DS3	1990-0485	1	LED-LAMP LUM-INT = 2MCD IF = 30MA-MAX BVR = 5V	01542	HLMP-1503
DS4	1990-0485	1	LED-LAMP LUM-INT = 2MCD IF = 30MA-MAX BVR = 5V	01542	HLMP-1503
F1	2110-0332	1	FUSE (INCH) 3A 125V NTD BI	02805	GMW 3
F2	2110-0425	1	FUSE (INCH) 2A 125V NTD BI	02805	GMW 2A
F3	2110-0424	1	FUSE (INCH) .75A 125V NTD BI	02805	GMW 3/4A
F4	2110-0476	1	FUSE (INCH) 4A 125V NTD BI	02805	GMW-4
F5	2110-0425	1	FUSE (INCH) 2A 125V NTD BI	02805	GMW 2A
F6	2110-0424	1	FUSE (INCH) .75A 125V NTD BI	02805	GMW 3/4A
F7	2110-0424	1	FUSE (INCH) .75A 125V NTD BI	02805	GMW 3/4A
J1	1251-8032	1	CONN-POST TYPE .156-PIN-SPCG 8-CONT	03418	26-60-4080
MP2	1200-0173	4	INSULATOR-XSTR DAP-GL	02210	A-10001 DAP
MP3	0380-1861	2	THREADED INSERT-STDF M2.5 X 0.45	03981	KFB3-M2.5-20
MP4	1205-0011	4	HEAT SINK TO-5/TO-39-CS	05792	TXBF-032-025B
MP5	0380-1246	4	SPACER-RVT-ON 6-MM-LG 3.8-MM-ID	02121	
P1	1251-8603	1	CONN-POST TYPE .100-PIN-SPCG 24-CONT	01380	1-534204-1
Q1	1884-0073	1	THYRISTOR-SCR VRRM = 100	02037	
Q2	1884-0018	1	THYRISTOR-SCR 2N4186 VRRM = 200		
Q3	1884-0073	1	THYRISTOR-SCR VRRM = 100	02037	
Q4	1884-0073	1	THYRISTOR-SCR VRRM = 100	02037	
Q5	1884-0073	1	THYRISTOR-SCR VRRM = 100	02037	

Table 6-2. Replaceable Parts

Ref Desig	HP Part Number	Qty	Description	Mfr Code	Mfr Part Number
R1	0757-0416	1	RESISTOR 511 $\pm$ 1% .125W TF TC=0 $\pm$ 100	02995	SFR25H
R2	0698-3444	1	RESISTOR 316 $\pm$ 1% .125W TF TC=0 $\pm$ 100	02995	SFR25H
R3	0698-3444	1	RESISTOR 316 $\pm$ 1% .125W TF TC=0 $\pm$ 100	02995	SFR25H
R4	0698-3444	1	RESISTOR 316 $\pm$ 1% .125W TF TC=0 $\pm$ 100	02995	SFR25H
R5	0757-0442	1	RESISTOR 10K $\pm$ 1% .125W TF TC=0 $\pm$ 100	02995	SFR25H
R6	0757-0403	1	RESISTOR 121 $\pm$ 1% .125W TF TC=0 $\pm$ 100	02995	SFR25H
R7	0757-0419	1	RESISTOR 681 $\pm$ 1% .125W TF TC=0 $\pm$ 100	02995	SFR25H
R8	0698-3132	1	RESISTOR 261 $\pm$ 1% .125W TF TC=0 $\pm$ 100	02995	SFR25H
R10	0757-0421	1	RESISTOR 825 $\pm$ 1% .125W TF TC=0 $\pm$ 100	02995	SFR25H
R11	0757-0405	1	RESISTOR 162 $\pm$ 1% .125W TF TC=0 $\pm$ 100	02995	SFR25H
R12	0698-0083	1	RESISTOR 1.96K $\pm$ 1% .125W TF TC=0 $\pm$ 100	02995	SFR25H
R13	0757-0405	1	RESISTOR 162 $\pm$ 1% .125W TF TC=0 $\pm$ 100	02995	SFR25H
R14	0698-0083	1	RESISTOR 1.96K $\pm$ 1% .125W TF TC=0 $\pm$ 100	02995	SFR25H
R15	0757-0442	1	RESISTOR 10K $\pm$ 1% .125W TF TC=0 $\pm$ 100	02995	SFR25H
R16	0757-0442	1	RESISTOR 10K $\pm$ 1% .125W TF TC=0 $\pm$ 100	02995	SFR25H
R17	0757-0346	1	RESISTOR 10 $\pm$ 1% .125W TF TC=0 $\pm$ 100	05524	CMF-55-1, T-1
R18	0757-0346	1	RESISTOR 10 $\pm$ 1% .125W TF TC=0 $\pm$ 100	05524	CMF-55-1, T-1
R19	0698-3601	1	RESISTOR 10 $\pm$ 5% 2W MO TC=0 $\pm$ 200	02499	GS-3
R20	0698-3601	1	RESISTOR 10 $\pm$ 5% 2W MO TC=0 $\pm$ 200	02499	GS-3
R21	0757-0280	1	RESISTOR 1K $\pm$ 1% .125W TF TC=0 $\pm$ 100	02995	SFR25H
R22	0757-0280	1	RESISTOR 1K $\pm$ 1% .125W TF TC=0 $\pm$ 100	02995	SFR25H
R23	0757-0280	1	RESISTOR 1K $\pm$ 1% .125W TF TC=0 $\pm$ 100	02995	SFR25H
R24	0757-0280	1	RESISTOR 1K $\pm$ 1% .125W TF TC=0 $\pm$ 100	02995	SFR25H
R25	0757-0401	1	RESISTOR 100 $\pm$ 1% .125W TF TC=0 $\pm$ 100	02995	SFR25H
R26	0757-0401	1	RESISTOR 100 $\pm$ 1% .125W TF TC=0 $\pm$ 100	02995	SFR25H
R27	0757-0401	1	RESISTOR 100 $\pm$ 1% .125W TF TC=0 $\pm$ 100	02995	SFR25H
R28	0757-0401	1	RESISTOR 100 $\pm$ 1% .125W TF TC=0 $\pm$ 100	02995	SFR25H
R29	0757-0346	1	RESISTOR 10 $\pm$ 1% .125W TF TC=0 $\pm$ 100	05524	CMF-55-1, T-1
R30	0698-3444	1	RESISTOR 316 $\pm$ 1% .125W TF TC=0 $\pm$ 100	02995	SFR25H
R31	0698-3444	1	RESISTOR 316 $\pm$ 1% .125W TF TC=0 $\pm$ 100	02995	SFR25H
R32	0698-3444	1	RESISTOR 316 $\pm$ 1% .125W TF TC=0 $\pm$ 100	02995	SFR25H
R33	0698-3444	1	RESISTOR 316 $\pm$ 1% .125W TF TC=0 $\pm$ 100	02995	SFR25H
R34	0698-3444	1	RESISTOR 316 $\pm$ 1% .125W TF TC=0 $\pm$ 100	02995	SFR25H
R35	2100-3755	1	RESISTOR-TRMR 50 10% TKF SIDE-ADJ 17-TRN	04568	67XR
R36	2100-3755	1	RESISTOR-TRMR 50 10% TKF SIDE-ADJ 17-TRN	04568	67XR
R37	0757-0442	1	RESISTOR 10K $\pm$ 1% .125W TF TC=0 $\pm$ 100	02995	SFR25H
R38	2100-3755	1	RESISTOR-TRMR 50 10% TKF SIDE-ADJ 17-TRN	04568	67XR
R39	2100-3755	1	RESISTOR-TRMR 50 10% TKF SIDE-ADJ 17-TRN	04568	67XR
TP1	0360-0535	1	CONNECTOR-SGL CONT TML-TS-PT	04055	
TP2	0360-0535	1	CONNECTOR-SGL CONT TML-TS-PT	04055	
TP3	0360-0535	1	CONNECTOR-SGL CONT TML-TS-PT	04055	
TP4	0360-0535	1	CONNECTOR-SGL CONT TML-TS-PT	04055	
TP5	0360-0535	1	CONNECTOR-SGL CONT TML-TS-PT	04055	
TP6	0360-0535	1	CONNECTOR-SGL CONT TML-TS-PT	04055	
VR1	1902-0958	1	DIODE-ZNR 10V 5% DO-35 PD=.4W TC=+.075%	02037	
VR2	1902-0953	1	DIODE-ZNR 6.2V 5% DO-35 PD=.4W TC=+.053%	02037	SZ30035-11RL
VR3	1902-3224	1	DIODE-ZNR 17.8V 5% DO-35 PD=.4W	02037	
VR4	1902-3224	1	DIODE-ZNR 17.8V 5% DO-35 PD=.4W	02037	
VR5	1902-3290	1	DIODE-ZNR 31.6V 5% DO-35 PD=.4W	02037	
VR6	1902-3182	1	DIODE-ZNR 12.1V 5% DO-35 PD=.4W	02037	
VR7	1902-3182	1	DIODE-ZNR 12.1V 5% DO-35 PD=.4W	02037	
X1	1251-2313	14	CONNECTOR-SGL CONT SKT .04-IN-BSC-SZ RND	01380	3-332070-5

Table 6-2. Replaceable Parts

Ref Desig	HP Part Number	Qty	Description	Mfr Code	Mfr Part Number
A6	08349-60075	1	BD AY-MTHR	28480	08349-60075
J1	1251-8494	1	CONN-POST TYPE .100-PIN-SPCG 24-CONT	01380	534978-4
J2	1251-8494	1	CONN-POST TYPE .100-PIN-SPCG 24-CONT	01380	534978-4
J3	1252-0638	1	CONN-POST TYPE .100-PIN-SPCG 10-CONT	01380	103168-3
J4	1251-8494	1	CONN-POST TYPE .100-PIN-SPCG 24-CONT	01380	534978-4
J5	1252-0208	1	CONN-POST TYPE .100-PIN-SPCG 24-CONT	01380	1-103166-0
J6	1200-1205	1	SOCKET-IC-DIP 16-CONT DIP DIP-SLDR	01380	2-641610-2
MP2	0380-1258	5	STANDOFF-PRESS-IN 16.00 MM LG; M 3.0 X	03981	KFSE-M3-16
VR1	1902-1429	1	DIODE-ZNR 5.11V 2% DO-35 PD=.4W	02037	

## A4 SIGNAL CONDITIONING BOARD, CIRCUIT DESCRIPTION

The main function of the A4 signal conditioning board is, as the name implies, to condition and route signals. The input signals are:

- VDET from the A2 amplifier assembly.
- 0.5V/GHz from a rear panel input or synthesizer interface J7.
- MM Module/Synthesizer sense lines from either the A6 motherboard or front/rear panel connectors.
- Power supply voltages from the AS regulator assembly.

There are two output signals generated by the signal conditioning board, VDISP and DET OUT. VDISP is used by the A1 display board to display the HP 8349B peak RF output power in dBm. DET OUT is connected directly to a rear panel BNC output which can be used to drive the external automatic leveling control (ALC) circuitry of an RF source.

### BLOCK A - $\pm 10$ VDC

Regulator U4 and operational amplifier U1 provide regulated  $\pm 10$  Vdc reference voltages for the flatness compensation circuitry BLOCK E and the dual slope log amplifier BLOCK B. U1 acts as an inverting amplifier with unity gain to provide the  $-10$  Vdc reference. The current required by the loads on the  $-10$  Vdc supply is provided by the  $-15$  VR power supply through A4R29.

### BLOCK B - DUAL SLOPE LOG AMPLIFIER

VDET from the internal detector on the A2 amplifier assembly is buffered and amplified (x5) by U8. U8 provides a high impedance input (INT DET) to the log amplifier to prevent loading of the A2 internal detector. U9, Q9 and Q2 form the dual slope log amplifier with Q11, Q1 and U1B configured as an adjustable current source to provide base currents IB1 and IB2. (See log converter description below.)

RT1 provides thermal compensation for the sensitivity drift of the A2 internal detector. The inverse compensation modifies the log amplifier base currents through amplifier U1B and matched transistor pair Q1A and Q1B.

The dual slope log amplifier signal is amplified (x10) and buffered by U5. U5 is also the summing junction for the flatness compensation circuitry. BLOCK E. The output of U5 is a compensation signal (INT LEV) which rises at a rate of 60mV/dB (with 0V = 0 dB as the reference) to a maximum of 1.200V (= 20 dB).

RT2 provides inverse thermal compensation for the log amplifier output. The log amplifier conversion equation is:

$$V_{out} = KT/q \ln(I_{in}/I_{out})$$

Note that it is directly proportional to temperature.

Resistor A4R36 provides a 50 ohm impedance to an external synthesizer through relay K2 and the synthesizer connector J7.

Adjustments on the A4 signal conditioning board are listed below with the reference designation adjustment name and functional description.

A4R14 (-20) The bias control for log amplifier input stage U9 Q2 and Q9.

A4R34 (-10) The gain control for output amplifier U5 which sets maximum output level.

A4R21 (0) The bias control for log amplifier Q2 which sets emitter bias for the matched transistor pair.

A4R23 (+15) The adjustable current source bias control which sets IB1 and IB2 current levels.

These A4 adjustments are referenced in Section 5, "Adjustments" under "Dual Slope Log Adjustments."

## Log Converter Description

Diode detectors characteristically exhibit two distinct regions of operation. At low power levels ( $< 0$  dBm) the detectors are in their "square law region." In this region the detector's output voltage is proportional to RF power. At high power levels the log converter output voltage is proportional to the square root of the RF power. The purpose of the log converter is to convert the detector's output voltage into a DC voltage which corresponds to RF power in dBm. For the log converter to accomplish this, the log converter outputs over its entire range a voltage proportional to the logarithm of the input voltage. However when the detector is operating in its "linear" region the log converter's gain is twice that of when the detector is operating in its "square law" region. This doubling of gain in the "linear" region ensures that the log converter output is logarithmically related to its input over the entire range.

Figure 8-15 illustrates a simplified single slope log converter. The "log" function is accomplished by Q1A using the transistor characteristic that the collector current is the exponential of the base-to-emitter voltage. U1 amplifies the detector voltage sinking the collector current of Q1A until it equals the input current developed by  $V_{in}$  across  $R_{in}$ . Q1A's emitter voltage is then log of the input voltage which passes through Q1B (wired as a diode) to the output.

To implement a "dual slope" log converter a second pair of transistors with bias currents is added as in Figure 8-16. Bias currents IB1 and IB2 are constant and nearly equal. Q1A and Q1B carry the logging current  $i_{in}$  and Q2A and Q2B carry IB1 and IB2. For low power levels (square law region) assume  $i_{in} \ll IB1$  and  $i_o$  (offset current)  $\ll IB2$ . Q2A and Q2B are then carrying essentially identical currents and their base-to-emitter voltages are identical. Also the emitter of Q1A is at the same voltage as the emitter of Q1B and the circuit acts like the single-slope logger of Figure 8-15. For high power levels (linear region)  $i_{in} \gg IB1$ . Q1A and Q2A now carry the same current  $i_{in}$  (IB1 can be ignored) and the base voltage of Q2A varies twice as much as the emitter of Q1A. Thus the gain of the logger is doubled when the detector is in its linear region and the log converter outputs a voltage proportional to a detected RF power over a wide range of power levels.

## Service Position Installation Procedure

1. Remove the four screws that secure the A4 signal conditioning board to the HP 8349B's center support.
2. Remove the A4 assembly from the A6 motherboard and connect the extender board, HP P/N 08349-60059 to the A6 motherboard and A4 board.
3. Loosen the allen screw on the rear of the center support until the A4 board is aligned. Tighten the allen screw to hold this position.

**NOTE:** Ensure all cable assemblies are still securely fastened after extending the A4 assembly.

4. Reverse this procedure for disassembly.

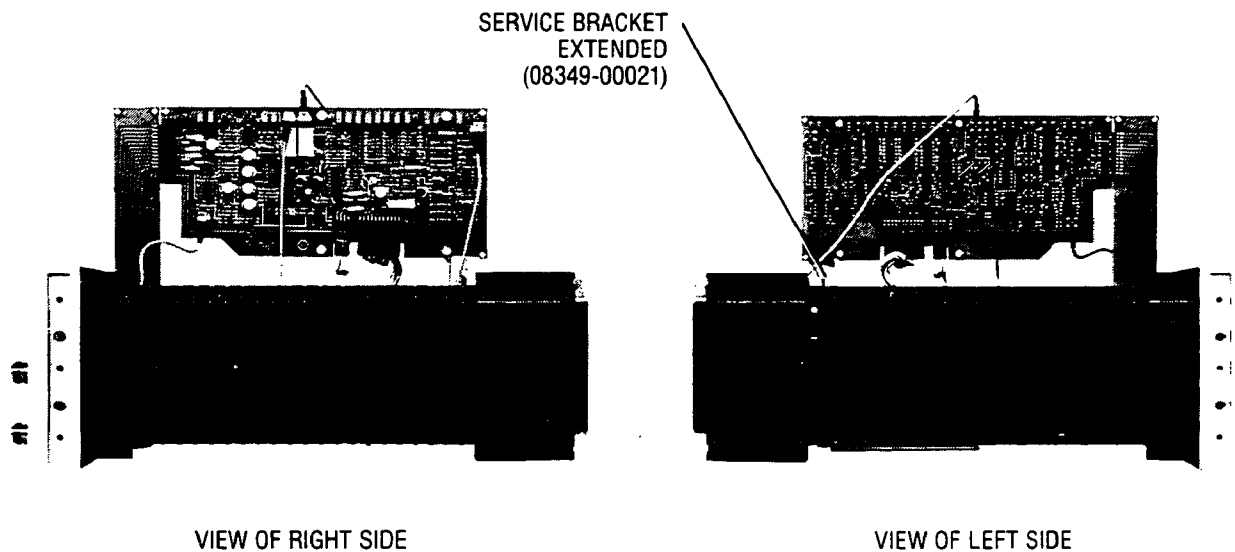

*Figure 8-18. A4 Signal Conditioning Board in Service Position*

A4

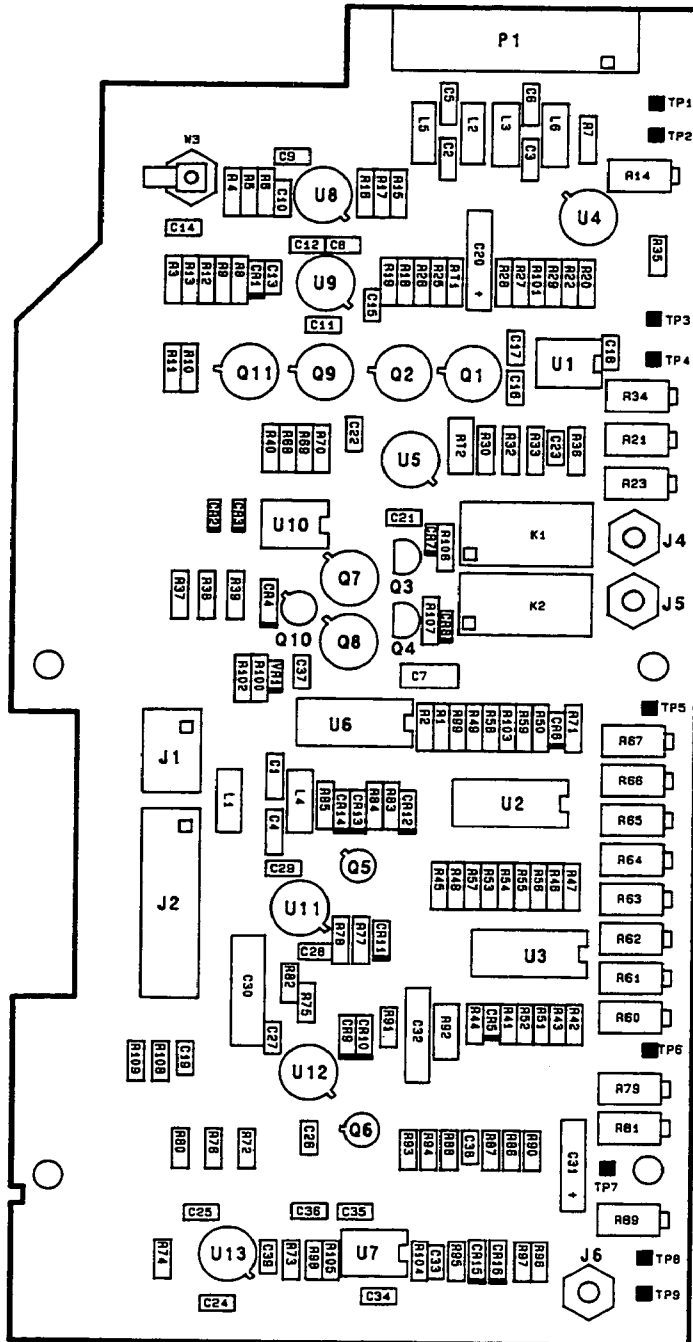

NOTE: Unless otherwise indicated: resistance in ohms ( $\Omega$ ), capacitance in microfarads ( $\mu\text{F}$ ), inductance in microhenries ( $\mu\text{H}$ ).

Figure 8-19. A4 Signal Conditioning, Component Locations Diagram



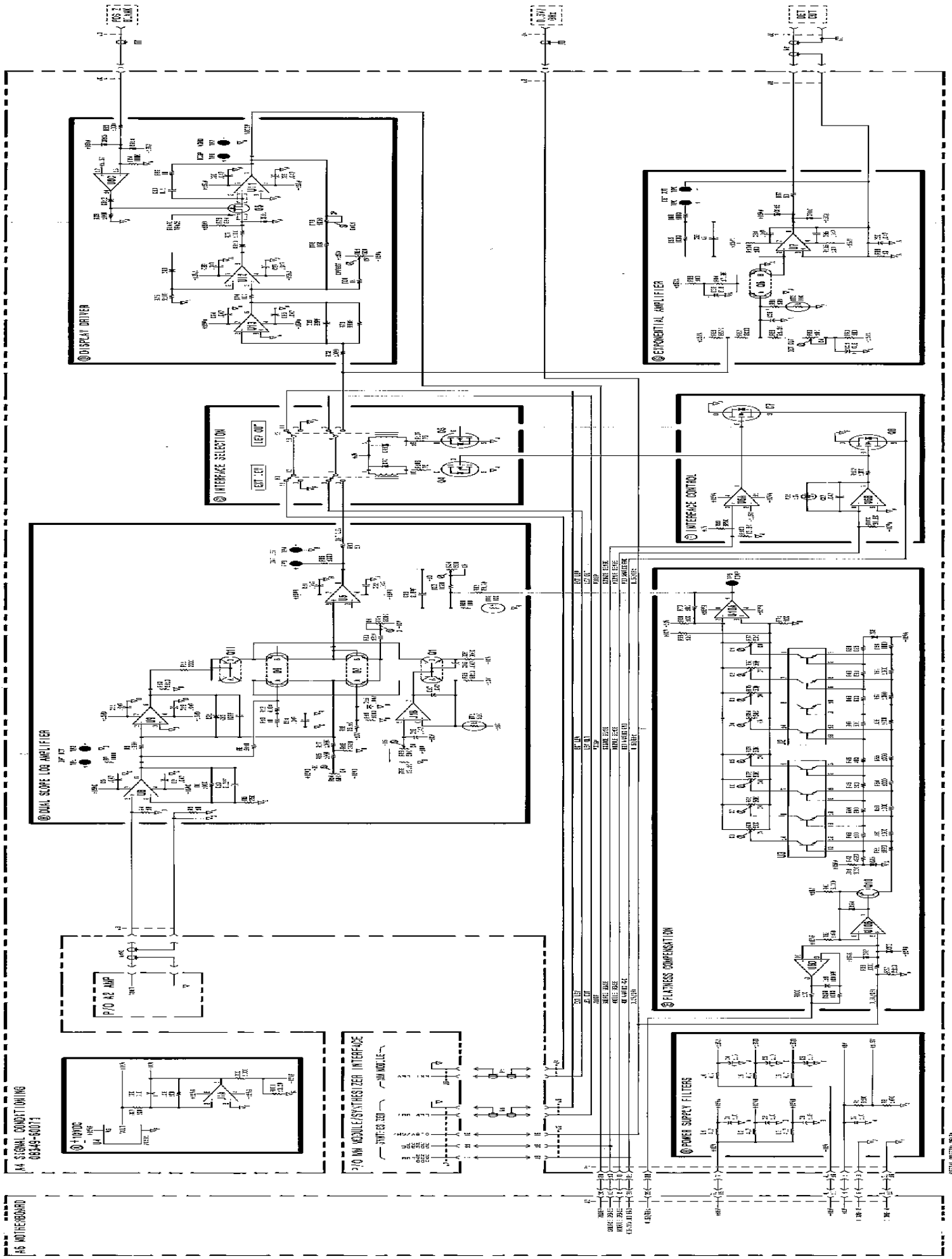

Figure 6-60 AS Signal Conditioning Schematic Diagram (Cont'd)

## **CHANGE C**

The following changes apply directly to the instruments with the serial prefix opposite this lettered change in Table 7-1 and should be used when servicing them.

**Replace the existing manual pages with the following pages:**

Title Page

6-11 through 6-14

8-43 (*only* if the A5Q2 in your instrument matches the A5Q2 in Figure 8-22 of this change).

# **HP 8349B MICROWAVE AMPLIFIER**

## **SERIAL NUMBERS**

This manual applies directly to HP 8349B Microwave Amplifiers having serial number prefix 2644A.

For additional information about serial numbers, refer to "Instruments Covered By Manual" in Section 1.

©Copyright            HEWLETT-PACKARD COMPANY            1985  
1400 FOUNTAINGROVE PARKWAY, SANTA ROSA, CA 95403 U.S.A.

MANUAL PART NO. 08349-90017

Printed: MAY 1991



## **CERTIFICATION**

*Hewlett-Packard Company certifies that this product met its published specifications at the time of shipment from the factory. Hewlett-Packard further certifies that its calibration measurements are traceable to the United States National Institute of Standards and Technology (NIST, formerly NBS), to the extent allowed by the Institute's calibration facility, and to the calibration facilities of other International Standards Organization members.*

## **WARRANTY**

This Hewlett-Packard instrument product is warranted against defects in material and workmanship for a period of one year from date of delivery. During the warranty period, Hewlett-Packard Company will, at its option, either repair or replace products which prove to be defective.

For warranty service or repair, this product must be returned to a service facility designated by HP. Buyer shall prepay shipping charges to HP and HP shall pay shipping charges to return the product to Buyer. However, Buyer shall pay all shipping charges, duties, and taxes for products returned to HP from another country.

HP warrants that its software and firmware designated by HP for use with an instrument will execute its programming instructions when properly installed on that instrument. HP does not warrant that the operation of the instrument, or software, or firmware will be uninterrupted or error free.

### **LIMITATION OF WARRANTY**

The foregoing warranty shall not apply to defects resulting from improper or inadequate maintenance by Buyer, Buyer-supplied software or interfacing, unauthorized modification or misuse, operation outside of the environmental specifications for the product, or improper site preparation or maintenance.

**NO OTHER WARRANTY IS EXPRESSED OR IMPLIED. HP SPECIFICALLY DISCLAIMS THE IMPLIED WARRANTIES OF MERCHANTABILITY AND FITNESS FOR A PARTICULAR PURPOSE.**

### **EXCLUSIVE REMEDIES**

**THE REMEDIES PROVIDED HEREIN ARE BUYER'S SOLE AND EXCLUSIVE REMEDIES. HP SHALL NOT BE LIABLE FOR ANY DIRECT, INDIRECT, SPECIAL, INCIDENTAL, OR CONSEQUENTIAL DAMAGES, WHETHER BASED ON CONTRACT, TORT, OR ANY OTHER LEGAL THEORY.**

## **ASSISTANCE**

*Product maintenance agreements and other customer assistance agreements are available for Hewlett-Packard products.*

*For any assistance, contact your nearest Hewlett-Packard Sales and Service Office. Addresses are provided at the back of this manual.*

Table 6-2. Replaceable Parts

REF DESIG	HP PART NUMBER	QTY	DESCRIPTION	MFR CODE	MFR PART NUMBER
R64	2100-3611	1	RESISTOR-TRMR 50K 10% TKF SIDE-ADJ	04568	67XR
R65	2100-3611	1	RESISTOR-TRMR 50K 10% TKF SIDE-ADJ	04568	67XR
R66	2100-3611	1	RESISTOR-TRMR 50K 10% TKF SIDE-ADJ	04568	67XR
R67	2100-3611	1	RESISTOR-TRMR 50K 10% TKF SIDE-ADJ	04568	67XR
R68	0757-0442	1	RESISTOR 10K ± 1% .125W TF TC=0±100	02995	SFR25H
R69	0757-0442	1	RESISTOR 10K ± 1% .125W TF TC=0±100	02995	SFR25H
R70	0757-0442	1	RESISTOR 10K ± 1% .125W TF TC=0±100	02995	SFR25H
R71	0757-0442	1	RESISTOR 10K ± 1% .125W TF TC=0±100	02995	SFR25H
R72	0757-0280	1	RESISTOR 1K ± 1% .125W TF TC=0±100	02995	SFR25H
R73	0698-3153	1	RESISTOR 3.83K ± 1% .125W TF TC=0±100	02995	SFR25H
R74	0757-0442	1	RESISTOR 10K ± 1% .125W TF TC=0±100	02995	SFR25H
R75	0757-0438	1	RESISTOR 5.11K ± 1% .125W TF TC=0±100	02995	SFR25H
R76	0757-0442	1	RESISTOR 10K ± 1% .125W TF TC=0±100	02995	SFR25H
R77	0757-0280	1	RESISTOR 1K ± 1% .125W TF TC=0±100	02995	SFR25H
R78	0683-2265	1	RESISTOR 22M ± 5% .25W CC TC=-900/+1200	01607	CB2265
R79	2100-0545	1	RESISTOR-TRMR 1K 10% TKF SIDE-ADJ 17-TRN	04568	67XR
R80	0698-8827	1	RESISTOR 1M ± 1% .125W TF TC=0±100	02995	SFR25H
R81	2100-3611	1	RESISTOR-TRMR 50K 10% TKF SIDE-ADJ	04568	67XR
R82	0757-0346	1	RESISTOR 10 ± 1% .125W TF TC=0±100	05524	CMF-55-1, T-1
R83	0757-0465	1	RESISTOR 100K ± 1% .125W TF TC=0±100	02995	SFR25H
R84	0757-0465	1	RESISTOR 100K ± 1% .125W TF TC=0±100	02995	SFR25H
R85	0757-0280	1	RESISTOR 1K ± 1% .125W TF TC=0±100	02995	SFR25H
R86	0698-3456	1	RESISTOR 287K ± 1% .125W TF TC=0±100	02995	SFR25H
R87	0698-8624	1	RESISTOR 2K ± 0.1% .125W TF TC=0±25	02995	5033R
R88	0757-0199	1	RESISTOR 21.5K ± 1% .125W TF TC=0±100	02995	SFR25H
R89	2100-0670	1	RESISTOR-TRMR 10K 10% TKF SIDE-ADJ	04568	67XR
R90	0757-0401	1	RESISTOR 100 ± 1% .125W TF TC=0±100	02995	SFR25H
R91	0757-0401	1	RESISTOR 100 ± 1% .125W TF TC=0±100	02995	SFR25H
R93	0757-0401	1	RESISTOR 100 ± 1% .125W TF TC=0±100	02995	SFR25H
R94	0698-3136	1	RESISTOR 17.8K ± 1% .125W TF TC=0±100	02995	SFR25H
R95	0757-0280	1	RESISTOR 1K ± 1% .125W TF TC=0±100	02995	SFR25H
R96	0757-0280	1	RESISTOR 1K ± 1% .125W TF TC=0±100	02995	SFR25H
R97	0698-8364	1	RESISTOR 50 ± 0.1% .125W TF TC=0±25	02995	5033R
R98	0757-0346	1	RESISTOR 10 ± 1% .125W TF TC=0±100	05524	CMF-55-1, T-1
R99	0757-0441	1	RESISTOR 8.25K ± 1% .125W TF TC=0±100	02995	SFR25H
R100	0698-3160	1	RESISTOR 31.6K ± 1% .125W TF TC=0±100	02995	SFR25H
R101	0757-0289	1	RESISTOR 13.3K ± 1% .125W TF TC=0±100	02995	SFR25H
R102	0757-0280	1	RESISTOR 1K ± 1% .125W TF TC=0±100	02995	SFR25H
R103	0757-0289	1	RESISTOR 13.3K ± 1% .125W TF TC=0±100	02995	SFR25H
R104	0757-0401	1	RESISTOR 100 ± 1% .125W TF TC=0±100	02995	SFR25H
R105	0757-0401	1	RESISTOR 100 ± 1% .125W TF TC=0±100	02995	SFR25H
R106	0757-0398	1	RESISTOR 75 ± 1% .125W TF TC=0±100	02995	SFR25H
R107	0757-0398	1	RESISTOR 75 ± 1% .125W TF TC=0±100	02995	SFR25H
R108	0757-0401	1	RESISTOR 100 ± 1% .125W TF TC=0±100	02995	SFR25H
R109	0757-0280	1	RESISTOR 1K ± 1% .125W TF TC=0±100	02995	SFR25H
RT1	0837-0345	1	THERMISTOR DISC 50K-OHM TC=-4.3-DEG	05524	8M5002-1
RT2	0837-0342	1	THERMISTOR TUB WITH AXL LEADS 100-OHM	06784	1K101J
RT3	0837-0342	1	THERMISTOR TUB WITH AXL LEADS 100-OHM	06784	1K101J
TP1	0360-0535	1	CONNECTOR-SGL CONT TML-TS-PT	04055	
TP2	0360-0535	1	CONNECTOR-SGL CONT TML-TS-PT	04055	
TP3	0360-0535	1	CONNECTOR-SGL CONT TML-TS-PT	04055	
TP4	0360-0535	1	CONNECTOR-SGL CONT TML-TS-PT	04055	
TP5	0360-0535	1	CONNECTOR-SGL CONT TML-TS-PT	04055	
TP6	0360-0535	1	CONNECTOR-SGL CONT TML-TS-PT	04055	
TP7	0360-0535	1	CONNECTOR-SGL CONT TML-TS-PT	04055	
TP8	0360-0535	1	CONNECTOR-SGL CONT TML-TS-PT	04055	
TP9	0360-0535	1	CONNECTOR-SGL CONT TML-TS-PT	04055	
U1	1826-0785	1	IC OP AMP LOW-BIAS-H-IMPD DUAL 8-DIP-C	02037	MC34002BU
U2	1858-0087	1	TRANSISTOR ARRAY 14-PIN PLSTC TO-116	02037	MPQ3904
U3	1858-0087	1	TRANSISTOR ARRAY 14-PIN PLSTC TO-116	02037	MPQ3904
U4	1826-0742	1	IC V RGLTR-V-REF-FXD 10V TO-5 PKG	03285	AD581J
U5	1826-0079	1	IC OP AMP WB 8-TO-99 PKG	03799	HA2-2625-5
U6	1826-0600	1	IC OP AMP LOW-BIAS-H-IMPD QUAD 14-DIP-P	01698	TL074ACN
U7	1826-1049	1	IC OP AMP PRCN 8-DIP-C PKG	02180	OP-27GZ
U8	1826-0516	1	IC OP AMP WB 8-TO-99 PKG	02180	OP-17FJ
U9	1826-0601	1	IC OP AMP PRCN 8-TO-99 PKG	02180	OP-16FJ
U10	1826-0785	1	IC OP AMP LOW-BIAS-H-IMPD DUAL 8-DIP-C	02037	MC34002BU
U11	1826-0601	1	IC OP AMP PRCN 8-TO-99 PKG	02180	OP-16FJ
U12	1826-0601	1	IC OP AMP PRCN 8-TO-99 PKG	02180	OP-16FJ
U13	1826-0601	1	IC OP AMP PRCN 8-TO-99 PKG	02180	OP-16FJ
U14	1820-0224	1	IC OP AMP SPCL 8-TO-99 PKG	03406	LH0002CH
VR1	1902-1173	1	DIODE-ZNR 1N4104 10V 5% PD=.5W IR=1UA	02037	
W3	08349-60068	1	W3 CABLE ASSEMBLY	28480	08349-60068

Table 6-2. Replaceable Parts

REF DESIG	HP PART NUMBER	QTY	DESCRIPTION	MFR CODE	MFR PART NUMBER
A5	08349-60040	1	BD AY-REGULATOR	28480	08349-60040
C1	0180-3394	1	CAP-FXD +50% -10% 25 V AL-ELCTLT	00493	SL25P103T30X51LL
C2	0180-3132	1	CAP-FXD 4700uF ±20% 35 V AL-ELCTLT	00493	SM35VP472M25X40
C3	0180-3395	1	CAP-FXD 1000uF ±20% 200 V AL-ELCTLT	00493	KM200VR102M35X50
C4	0180-3395	1	CAP-FXD 1000uF ±20% 200 V AL-ELCTLT	00493	KM200VR102M35X50
C5	0180-0291	1	CAP-FXD 1uF ±10% 35 V TA	04200	150D105X9035A2-DYS
C6	0180-0291	1	CAP-FXD 1uF ±10% 35 V TA	04200	150D105X9035A2-DYS
C7	0180-0291	1	CAP-FXD 1uF ±10% 35 V TA	04200	150D105X9035A2-DYS
C8	0180-0291	1	CAP-FXD 1uF ±10% 35 V TA	04200	150D105X9035A2-DYS
C9	0180-0230	1	CAP-FXD 1uF ±20% 50 V TA	04200	150D105X0050A2-DYS
C10	0180-0230	1	CAP-FXD 1uF ±20% 50 V TA	04200	150D105X0050A2-DYS
C11	0180-0291	1	CAP-FXD 1uF ±10% 35 V TA	04200	150D105X9035A2-DYS
C12	0180-0291	1	CAP-FXD 1uF ±10% 35 V TA	04200	150D105X9035A2-DYS
C15	0180-0116	1	CAP-FXD 6.8uF ±10% 35 V TA	04200	150D685X9035B2-DYS
C16	0180-0116	1	CAP-FXD 6.8uF ±10% 35 V TA	04200	150D685X9035B2-DYS
C17	0180-0116	1	CAP-FXD 6.8uF ±10% 35 V TA	04200	150D685X9035B2-DYS
C18	0180-0116	1	CAP-FXD 6.8uF ±10% 35 V TA	04200	150D685X9035B2-DYS
C20	0160-0168	1	CAP-FXD 0.1uF ±10% 200 V POLYE-FL	05176	HEW238T
C21	0160-0168	1	CAP-FXD 0.1uF ±10% 200 V POLYE-FL	05176	HEW238T
C22	0160-0168	1	CAP-FXD 0.1uF ±10% 200 V POLYE-FL	05176	HEW238T
C24	0160-4535	1	CAP-FXD 1uF ±10% 50 V CER X7R	09939	RPE113-130X7R105K50V
C25	0160-4535	1	CAP-FXD 1uF ±10% 50 V CER X7R	09939	RPE113-130X7R105K50V
C26	0160-4535	1	CAP-FXD 1uF ±10% 50 V CER X7R	09939	RPE113-130X7R105K50V
C27	0160-4535	1	CAP-FXD 1uF ±10% 50 V CER X7R	09939	RPE113-130X7R105K50V
C28	0160-3879	1	CAP-FXD 0.01uF ±20% 100 V CER X7R	02010	SR201C103MAAH
CR1	1901-0935	1	DIODE-PWR RECT 45V 8A	03038	
CR2	1901-0935	1	DIODE-PWR RECT 45V 8A	03038	
CR3	1901-0935	1	DIODE-PWR RECT 45V 8A	03038	
CR4	1901-0935	1	DIODE-PWR RECT 45V 8A	03038	
CR5	1901-0693	1	DIODE-PWR RECT 100V 1A 200NS DO-41	04504	1N4934
CR6	1901-0693	1	DIODE-PWR RECT 100V 1A 200NS DO-41	04504	1N4934
CR7	1901-0693	1	DIODE-PWR RECT 100V 1A 200NS DO-41	04504	1N4934
CR8	1901-0693	1	DIODE-PWR RECT 100V 1A 200NS DO-41	04504	1N4934
CR10	1901-0965	1	DIODE-PWR RECT 100V 3A 200NS	02037	
CR11	1901-0965	1	DIODE-PWR RECT 100V 3A 200NS	02037	
CR12	1901-0965	1	DIODE-PWR RECT 100V 3A 200NS	02037	
CR13	1901-0965	1	DIODE-PWR RECT 100V 3A 200NS	02037	
CR17	1901-0028	1	DIODE-PWR RECT 400V 750MA DO-29	02664	SS5117
CR18	1901-0028	1	DIODE-PWR RECT 400V 750MA DO-29	02664	SS5117
CR19	1901-0028	1	DIODE-PWR RECT 400V 750MA DO-29	02664	SS5117
CR20	1901-0028	1	DIODE-PWR RECT 400V 750MA DO-29	02664	SS5117
CR21	1901-0028	1	DIODE-PWR RECT 400V 750MA DO-29	02664	SS5117
CR22	1901-0028	1	DIODE-PWR RECT 400V 750MA DO-29	02664	SS5117
CR23	1901-0028	1	DIODE-PWR RECT 400V 750MA DO-29	02664	SS5117
CR24	1901-0028	1	DIODE-PWR RECT 400V 750MA DO-29	02664	SS5117
CR25	1901-0028	1	DIODE-PWR RECT 400V 750MA DO-29	02664	SS5117
CR26	1901-0028	1	DIODE-PWR RECT 400V 750MA DO-29	02664	SS5117
CR27	1901-0028	1	DIODE-PWR RECT 400V 750MA DO-29	02664	SS5117
CR28	1901-0028	1	DIODE-PWR RECT 400V 750MA DO-29	02664	SS5117
CR29	1901-0662	1	DIODE-PWR RECT 100V 6A	02037	MR751
DS1	1990-0485	1	LED-LAMP LUM-INT = 2MCD IF = 30MA-MAX BVR = 5V	01542	HLMP-1503
DS2	1990-0485	1	LED-LAMP LUM-INT = 2MCD IF = 30MA-MAX BVR = 5V	01542	HLMP-1503
DS3	1990-0485	1	LED-LAMP LUM-INT = 2MCD IF = 30MA-MAX BVR = 5V	01542	HLMP-1503
DS4	1990-0485	1	LED-LAMP LUM-INT = 2MCD IF = 30MA-MAX BVR = 5V	01542	HLMP-1503
F1	2110-0332	1	FUSE (INCH) 3A 125V NTD BI	02805	GMW 3
F2	2110-0425	1	FUSE (INCH) 2A 125V NTD BI	02805	GMW 2A
F3	2110-0424	1	FUSE (INCH) .75A 125V NTD BI	02805	GMW 3/4A
F4	2110-0476	1	FUSE (INCH) 4A 125V NTD BI	02805	GMW-4
F5	2110-0425	1	FUSE (INCH) 2A 125V NTD BI	02805	GMW 2A
F6	2110-0424	1	FUSE (INCH) .75A 125V NTD BI	02805	GMW 3/4A
F7	2110-0424	1	FUSE (INCH) .75A 125V NTD BI	02805	GMW 3/4A
J1	1251-8032	1	CONN-POST TYPE .156-PIN-SPCG 8-CONT	03418	26-60-4080
MP2	1200-0173	4	INSULATOR-XSTR DAP-GL	02210	A-10001 DAP
MP3	0380-1861	2	THREADED INSERT-STDF M2.5 X 0.45	03981	KFB3-M2.5-20
MP4	1205-0011	4	HEAT SINK TO-5/TO-39-CS	05792	TXBF-032-025B
MP5	0380-1246	4	SPACER-RVT-ON 6-MM-LG 3.8-MM-ID	02121	
P1	1251-8603	1	CONN-POST TYPE .100-PIN-SPCG 24-CONT	01380	1-534204-1
Q1	1884-0073	1	THYRISTOR-SCR VRRM = 100	02037	
Q2			SEE NOTE ON PAGE 6-13		
Q3	1884-0073	1	THYRISTOR-SCR VRRM = 100	02037	
Q4	1884-0073	1	THYRISTOR-SCR VRRM = 100	02037	

Table 6-2. Replaceable Parts

REF DESIG	HP PART NUMBER	QTY	DESCRIPTION	MFR CODE	MFR PART NUMBER
Q5	1884-0073	1	THYRISTOR-SCR VRRM=100	02037	
R1	0757-0416	1	RESISTOR 511 $\pm$ 1% .125W TF TC=0 $\pm$ 100	02995	SFR25H
R2	0698-3444	1	RESISTOR 316 $\pm$ 1% .125W TF TC=0 $\pm$ 100	02995	SFR25H
R3	0698-3444	1	RESISTOR 316 $\pm$ 1% .125W TF TC=0 $\pm$ 100	02995	SFR25H
R4	0698-3444	1	RESISTOR 316 $\pm$ 1% .125W TF TC=0 $\pm$ 100	02995	SFR25H
R5	0757-0442	1	RESISTOR 10K $\pm$ 1% .125W TF TC=0 $\pm$ 100	02995	SFR25H
R6	0757-0403	1	RESISTOR 121 $\pm$ 1% .125W TF TC=0 $\pm$ 100	02995	SFR25H
R7	0757-0419	1	RESISTOR 681 $\pm$ 1% .125W TF TC=0 $\pm$ 100	02995	SFR25H
R8	0698-3132	1	RESISTOR 261 $\pm$ 1% .125W TF TC=0 $\pm$ 100	02995	SFR25H
R10	0757-0421	1	RESISTOR 825 $\pm$ 1% .125W TF TC=0 $\pm$ 100	02995	SFR25H
R11	0757-0405	1	RESISTOR 162 $\pm$ 1% .125W TF TC=0 $\pm$ 100	02995	SFR25H
R12	0698-0083	1	RESISTOR 1.96K $\pm$ 1% .125W TF TC=0 $\pm$ 100	02995	SFR25H
R13	0757-0405	1	RESISTOR 162 $\pm$ 1% .125W TF TC=0 $\pm$ 100	02995	SFR25H
R14	0698-0083	1	RESISTOR 1.96K $\pm$ 1% .125W TF TC=0 $\pm$ 100	02995	SFR25H
R15	0757-0442	1	RESISTOR 10K $\pm$ 1% .125W TF TC=0 $\pm$ 100	02995	SFR25H
R16	0757-0442	1	RESISTOR 10K $\pm$ 1% .125W TF TC=0 $\pm$ 100	02995	SFR25H
R17	0757-0346	1	RESISTOR 10 $\pm$ 1% .125W TF TC=0 $\pm$ 100	05524	CMF-55-1, T-1
R18	0757-0346	1	RESISTOR 10 $\pm$ 1% .125W TF TC=0 $\pm$ 100	05524	CMF-55-1, T-1
R19	0698-3601	1	RESISTOR 10 $\pm$ 5% 2W MO TC=0 $\pm$ 200	02499	GS-3
R20	0698-3601	1	RESISTOR 10 $\pm$ 5% 2W MO TC=0 $\pm$ 200	02499	GS-3
R21	0757-0280	1	RESISTOR 1K $\pm$ 1% .125W TF TC=0 $\pm$ 100	02995	SFR25H
R22	0757-0280	1	RESISTOR 1K $\pm$ 1% .125W TF TC=0 $\pm$ 100	02995	SFR25H
R23	0757-0280	1	RESISTOR 1K $\pm$ 1% .125W TF TC=0 $\pm$ 100	02995	SFR25H
R24	0757-0280	1	RESISTOR 1K $\pm$ 1% .125W TF TC=0 $\pm$ 100	02995	SFR25H
R25	0757-0401	1	RESISTOR 100 $\pm$ 1% .125W TF TC=0 $\pm$ 100	02995	SFR25H
R26	0757-0401	1	RESISTOR 100 $\pm$ 1% .125W TF TC=0 $\pm$ 100	02995	SFR25H
R27	0757-0401	1	RESISTOR 100 $\pm$ 1% .125W TF TC=0 $\pm$ 100	02995	SFR25H
R28	0757-0401	1	RESISTOR 100 $\pm$ 1% .125W TF TC=0 $\pm$ 100	02995	SFR25H
R29	0757-0346	1	RESISTOR 10 $\pm$ 1% .125W TF TC=0 $\pm$ 100	05524	CMF-55-1, T-1
R30	0698-3444	1	RESISTOR 316 $\pm$ 1% .125W TF TC=0 $\pm$ 100	02995	SFR25H
R31	0698-3444	1	RESISTOR 316 $\pm$ 1% .125W TF TC=0 $\pm$ 100	02995	SFR25H
R32	0698-3444	1	RESISTOR 316 $\pm$ 1% .125W TF TC=0 $\pm$ 100	02995	SFR25H
R33	0698-3444	1	RESISTOR 316 $\pm$ 1% .125W TF TC=0 $\pm$ 100	02995	SFR25H
R34	0698-3444	1	RESISTOR 316 $\pm$ 1% .125W TF TC=0 $\pm$ 100	02995	SFR25H
R35	2100-3755	1	RESISTOR-TRMR 50 10% TKF SIDE-ADJ 17-TRN	04568	67XR
R36	2100-3755	1	RESISTOR-TRMR 50 10% TKF SIDE-ADJ 17-TRN	04568	67XR
R37	0757-0442	1	RESISTOR 10K $\pm$ 1% .125W TF TC=0 $\pm$ 100	02995	SFR25H
R38	2100-3755	1	RESISTOR-TRMR 50 10% TKF SIDE-ADJ 17-TRN	04568	67XR
R39	2100-3755	1	RESISTOR-TRMR 50 10% TKF SIDE-ADJ 17-TRN	04568	67XR
TP1	0360-0535	1	CONNECTOR-SGL CONT TML-TS-PT	04055	
TP2	0360-0535	1	CONNECTOR-SGL CONT TML-TS-PT	04055	
TP3	0360-0535	1	CONNECTOR-SGL CONT TML-TS-PT	04055	
TP4	0360-0535	1	CONNECTOR-SGL CONT TML-TS-PT	04055	
TP5	0360-0535	1	CONNECTOR-SGL CONT TML-TS-PT	04055	
TP6	0360-0535	1	CONNECTOR-SGL CONT TML-TS-PT	04055	
VR1	1902-0958	1	DIODE-ZNR 10V 5% DO-35 PD=.4W TC=+.075%	02037	
VR2	1902-0953	1	DIODE-ZNR 6.2V 5% DO-35 PD=.4W TC=+.053%	02037	SZ30035-11RL
VR3	1902-3224	1	DIODE-ZNR 17.8V 5% DO-35 PD=.4W	02037	
VR4	1902-3224	1	DIODE-ZNR 17.8V 5% DO-35 PD=.4W	02037	
VR5	1902-1413	1	DIODE-ZNR 36V 5% DO-35 PD=.4W	02037	
VR6	1902-3182	1	DIODE-ZNR 12.1V 5% DO-35 PD=.4W	02037	
VR7	1902-3182	1	DIODE-ZNR 12.1V 5% DO-35 PD=.4W	02037	
X1	1251-2313	14	CONNECTOR-SGL CONT SKT .04-IN-BSC-SZ RND	01380	3-332070-5

NOTE: A5Q2, 1884-0018, IS NO LONGER MANUFACTURED. IF THIS PART FAILS, ORDER PART NUMBER 08348-60004, POWER SUPPLY REPLACEMENT KIT, TO UPGRADE THE A5 ASSEMBLY TO THE NEWEST REVISION.

*Table 6-2. Replaceable Parts*

REF DESIG	HP PART NUMBER	QTY	DESCRIPTION	MFR CODE	MFR PART NUMBER
A6	08349-60075	1	BD AY-MTHR	28480	08349-60075
J1	1251-8494	1	CONN-POST TYPE .100-PIN-SPCG 24-CONT	01380	534978-4
J2	1251-8494	1	CONN-POST TYPE .100-PIN-SPCG 24-CONT	01380	534978-4
J3	1252-0638	1	CONN-POST TYPE .100-PIN-SPCG 10-CONT	01380	103168-3
J4	1251-8494	1	CONN-POST TYPE .100-PIN-SPCG 24-CONT	01380	534978-4
J5	1252-0208	1	CONN-POST TYPE .100-PIN-SPCG 24-CONT	01380	1-103168-0
J6	1200-1205	1	SOCKET-IC-DIP 16-CONT DIP DIP-SLDR	01380	2-641810-2
MP2	0380-1258	5	STANDOFF-PRESS-IN 16.00 MM LG; M 3.0 X	03981	KFSE-M3-16
R1	0757-0442	1	RESISTOR 10K $\pm$ 1% .125W TF TC=0 $\pm$ 100	02995	SFR25H
VR1	1802-1429	1	DIODE-ZNR 5.11V 2% DO-35 PD=.4W	02037	



**TOP VIEW**

LOOSEN TOP AND BOTTOM SCREWS  
(bottom screw not visible)

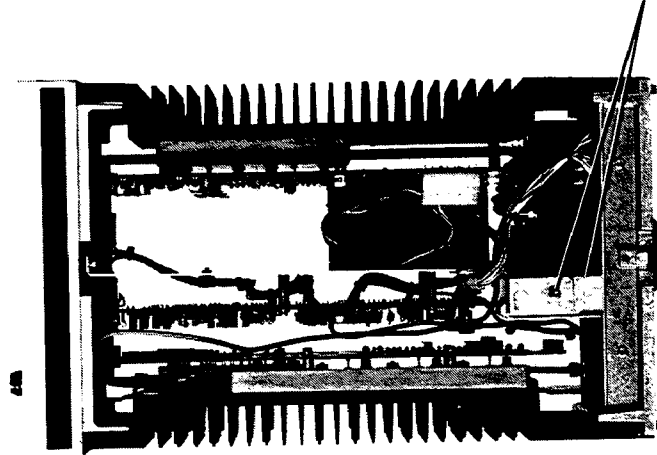

**A5 REGULATOR BOARD AND HEAT SINK IN SERVICE POSITION**

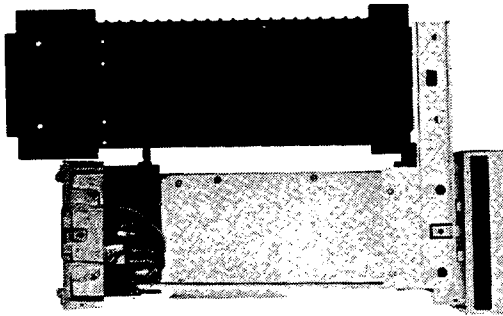

VIEW OF LEFT SIDE

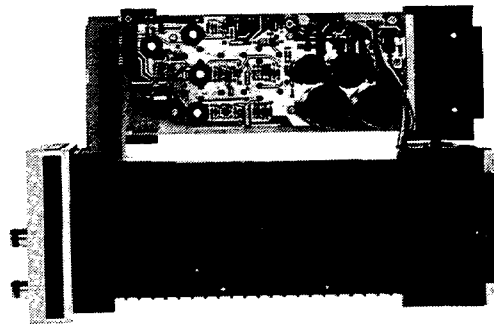

VIEW OF RIGHT SIDE

*Figure 8-21. Service Position Installation (2 of 2)*

A5

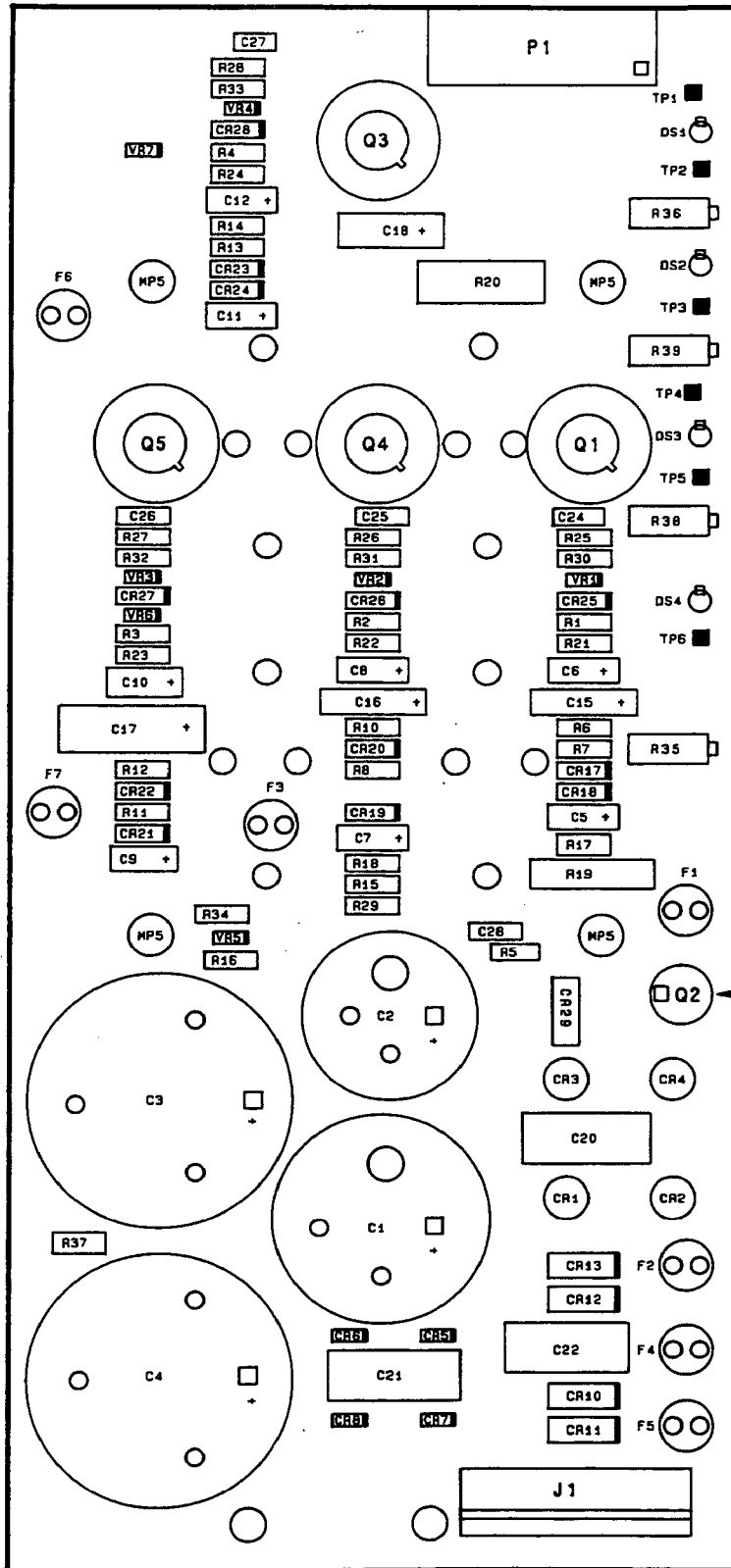

NOTE: Compare this diagram to the A5 assembly in your instrument. If Q2 looks different, your board has been updated. Do not replace the existing figure 8-22 in this manual with this diagram.

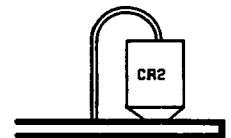

Figure 8-22. A5 Regulator, Component Locations Diagram



## Section 8. Service

---

### INTRODUCTION

This section provides instructions for troubleshooting and repairing the HP 8349B Microwave Amplifier. It begins with an overall description and block diagram of the amplifier. Following this is theory, troubleshooting, component layout diagrams and schematics for each of the five major assemblies.

### CAUTION NOTES

The CAUTION sign indicates a possible hazard to the instrument. Do not proceed beyond a CAUTION sign until the indicated conditions are fully understood and met.

**WARNING**

**Maintenance described in this section is performed with power supplied to the instrument with the protective covers removed. Such maintenance should be performed only by service-trained personnel who are aware of the hazards involved. Where maintenance can be accomplished without power applied to the instrument, the power should be removed. When you have completed a repair, make sure all safety features are intact and functioning, and that all protective grounds are connected.**

### SCHEMATIC DIAGRAM SYMBOLS AND TERMS

Symbols and terms used on the schematic diagrams are explained in Figure 8-1.

### SERVICE AIDS

One extender bracket, HP part number 08349-00005, and two extender boards, HP part numbers 08349-60058 and 08349-60059, are supplied with the HP 8349B. They are shown in Figure 1-2. The boards and bracket enable you to raise specific assemblies up for troubleshooting while maintaining necessary connections.

### THEORY OF OPERATION

The operation of the HP 8349B is described to assist with troubleshooting procedures. An overall block diagram, and schematic and component diagrams for the various subassemblies, are supplied.

## TROUBLESHOOTING

Troubleshooting the HP 8349B begins by performing the Operator's Check (Section 3) and the Performance Tests (Section 4). If a problem persists, refer to "Troubleshooting Procedures" later in this section. The troubleshooting procedures are designed to help the technician isolate a problem to the defective component.

## RECOMMENDED TEST EQUIPMENT

The necessary equipment needed to test and maintain the HP 8349B is listed in Section 1, General Information. If the equipment listed is not available, equipment that meets the critical specifications listed may be substituted.

## TROUBLESHOOTING EQUIPMENT

In addition to the previously recommended test equipment, the following tools are necessary for disassembly and troubleshooting.

Description	HP Part Number	Description	HP Part Number
2.5 mm Allen Wrench	8710-1181	1/4 inch Nut Driver	8720-0002
3.0 mm Allen Wrench	8710-0911	1/2 inch Nut Driver	8720-0007
Large Posidrive	8710-0900	5.5 mm Nut Driver	8710-1220
Medium Posidrive	8710-0899	7 mm Nut Driver	8710-1217
5/16 inch Open End Wrench	8720-0015	Needlenose Pliers	8710-0595
3/8 inch Open End Wrench	8720-0016	Wirecutters	8710-0592
9/16 inch Open End Wrench	8720-0025	Wire Strippers	8710-0052
3/16 inch Nut Driver	8720-0001	Soldering Iron	8690-0220

## GENERAL MAINTENANCE

### Microcircuit



**CAUTION**

When working inside the amplifier, be very careful not to touch any of the exposed pins coming from the microcircuit. The microcircuit is extremely static sensitive, and may be damaged or destroyed by charges typically carried during everyday activities. When working near the microcircuit, always wear a static ground strap. Never touch the center contacts of the RF connectors without static protection.

### Rigid Cables

If you must loosen or remove one of the rigid RF cables, be very careful not to bend it. Bending one of these cables can change its electrical characteristics.

## Repairs on the Circuit Boards

Component mounting holes are plated through to both sides of the board. Because of this, you can solder or unsolder from either side.

### CAUTION

**Do not use a high wattage soldering iron on the etched circuit board. Avoid using sharp metal objects to clean solder from plated through component mounting holes. You may damage the plating and cause an open circuit. Use an anti-static type suction device or a toothpick for solder removal.**

**Use only mildly active rosin core solder (RMA) when repairing the circuit board. Do not attempt to clean excess flux from the soldered connections, as this can release chlorides that will cause corrosion. Always use a soldering iron with a grounded tip and work at an anti-static work station to prevent static discharge damage during repairs.**

## Printed Circuit Board Markings

On the printed circuit board, a square pad is etched around one pin of some components to facilitate identification of the component terminals. The square pad indicates the following:

- a. Cathode of a diode
- b. Emitter of a transistor
- c. Source terminal of a FET.
- d. Pin one of an integrated circuit.
- e. Pin one of an integrated circuit socket.
- f. Pin one of a cable connector.

## BASIC COMPONENT SYMBOLOGY















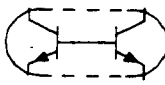













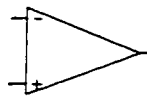
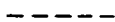













R, L, C	Resistance is in ohms, inductance is in microhenries, capacitance is in microfarads, unless otherwise noted.		Pin Edge Connector output of PC board.		FET: Field Effect Transistor (N-channel).
P/O	Part of.		Indicates wire or cable color code. Color code same as resistor color code. First number indicates base color, second and third numbers indicate colored stripes.		FET: Field Effect Transistor-Guarded gate- (N channel).
*	Indicates a factory selected component.		Indicates a soldered or mechanical connection.		Dual Transistor.
	Panel Control.		Indicates shielding conductor for cables.		Transistor NPN
	Screwdriver adjustment.		Indicates a plug-in connection.		Transistor PNP
	Encloses front panel designation.		Indicates a soldered or mechanical connection.		Electrolytic Capacitor.
	Encloses rear panel designation.		Connection symbol indicating a male connection.		Toroid: Magnetic core inductor.
	Circuit assembly border-line.		Connection symbol indicating a female connection.		Operational Amplifier.
	Other assembly border-line.		Resistor.		Fuse
	Heavy line with arrows indicates path and direction of main signal.		Variable Resistor.		Pushbutton Switch.
	Indicates path and direction of main feedback.		General purpose diode.		Toggle Switch.
	Earth ground symbol.		Step recovery diode.		Thermal Switch.
	Assembly ground. May be accompanied by a number or letter to specify a particular ground.		Schottky diode.		Summing Point.
	Chassis ground.		Breakdown Diode: Zener		Oscillator; RPG (Rotary Pulse Generator).
	Represents n number of transmission paths.		Light-Emitting Diode.		Fan, Motor.
	Test Point: Terminal provided for test probe.		SCR (Silicon Controlled Rectifier).		Toroidal Transformer
			Thermistor		

Figure 8-1. Schematic Diagram Notes

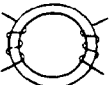
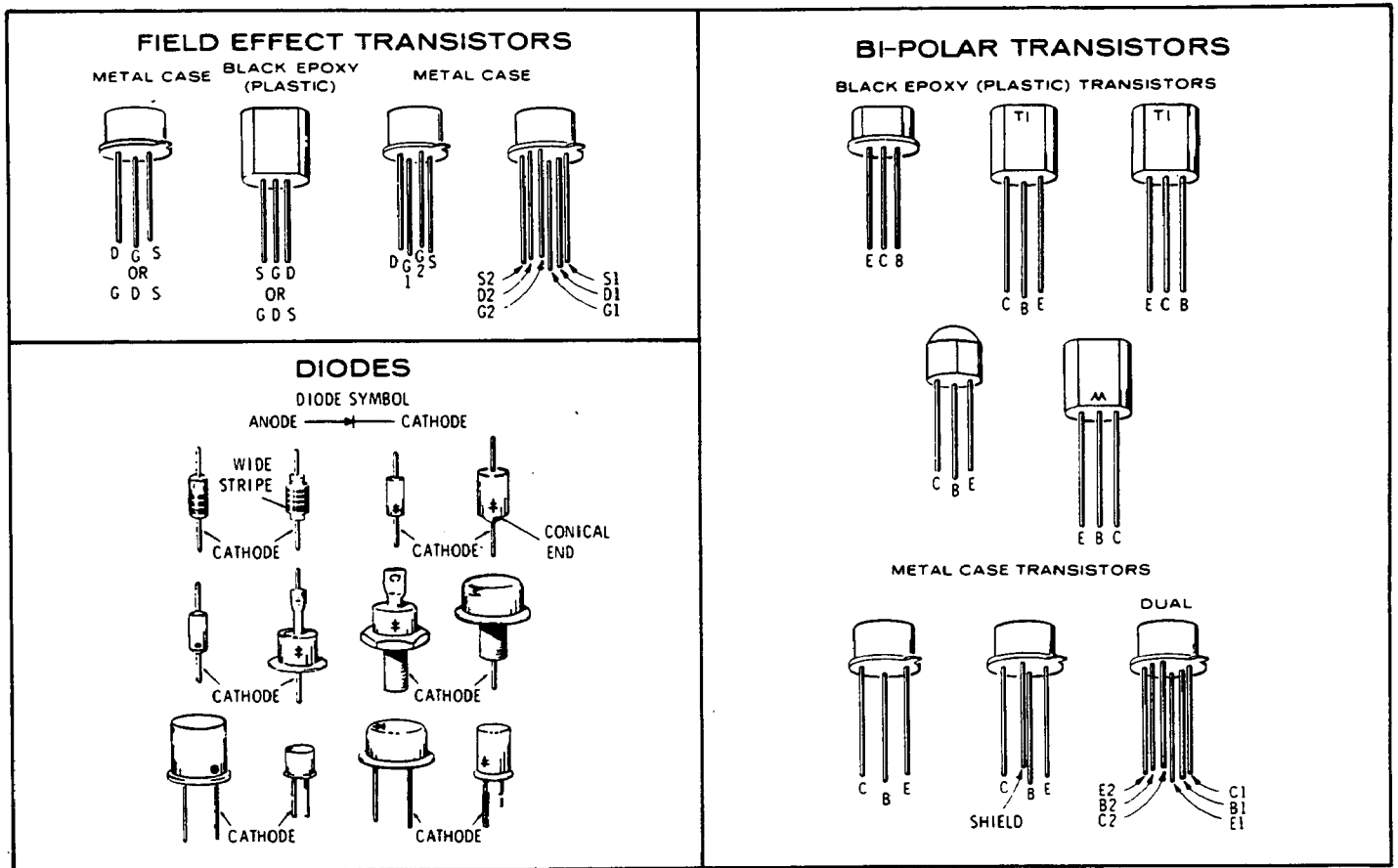

Figure 8-2. Examples of Diode and Transistor Marking Methods

## HP 8349B OVERALL DESCRIPTION

The major assemblies of the HP 8349B are:

- A1 Display Board
- A2 Amplifier Assembly
- A3 Bias Board
- A4 Signal Conditioning Board
- A5 Regulator Board
- A6 Motherboard and  
Module Synthesizer Interface (no reference designation)

The A2 amplifier takes the signal at the RF INPUT and amplifies it to produce the RF OUTPUT signal. The A3 bias board provides regulated bias voltages for the A2 amplifier. The A4 signal conditioning board receives the detected RF OUTPUT signal (VDET) from the A2 amplifier and converts it to a signal (VDISP) which is proportional to RF power in dBm. The A4 board also controls the Source Module/Synthesizer Interface which provides a log or linear detector output depending upon which type of source is connected during millimeter-wave applications. The A1 display board receives VDISP from the A4 board and uses it to display the RF OUTPUT power on the front panel power level display. The A5 regulator board generates the DC voltages required by the HP 8349B. The A6 motherboard acts as the interconnect for the major assemblies in the HP 8349B. The Module/Synthesizer Interface is the millimeter wave system interface and provides proper signal routing through the amplifier for various modes of operation during millimeter wave applications.



HP 8310B MICROWAVE AMPLIFIER  
OVERALL BLOCK DIAGRAM

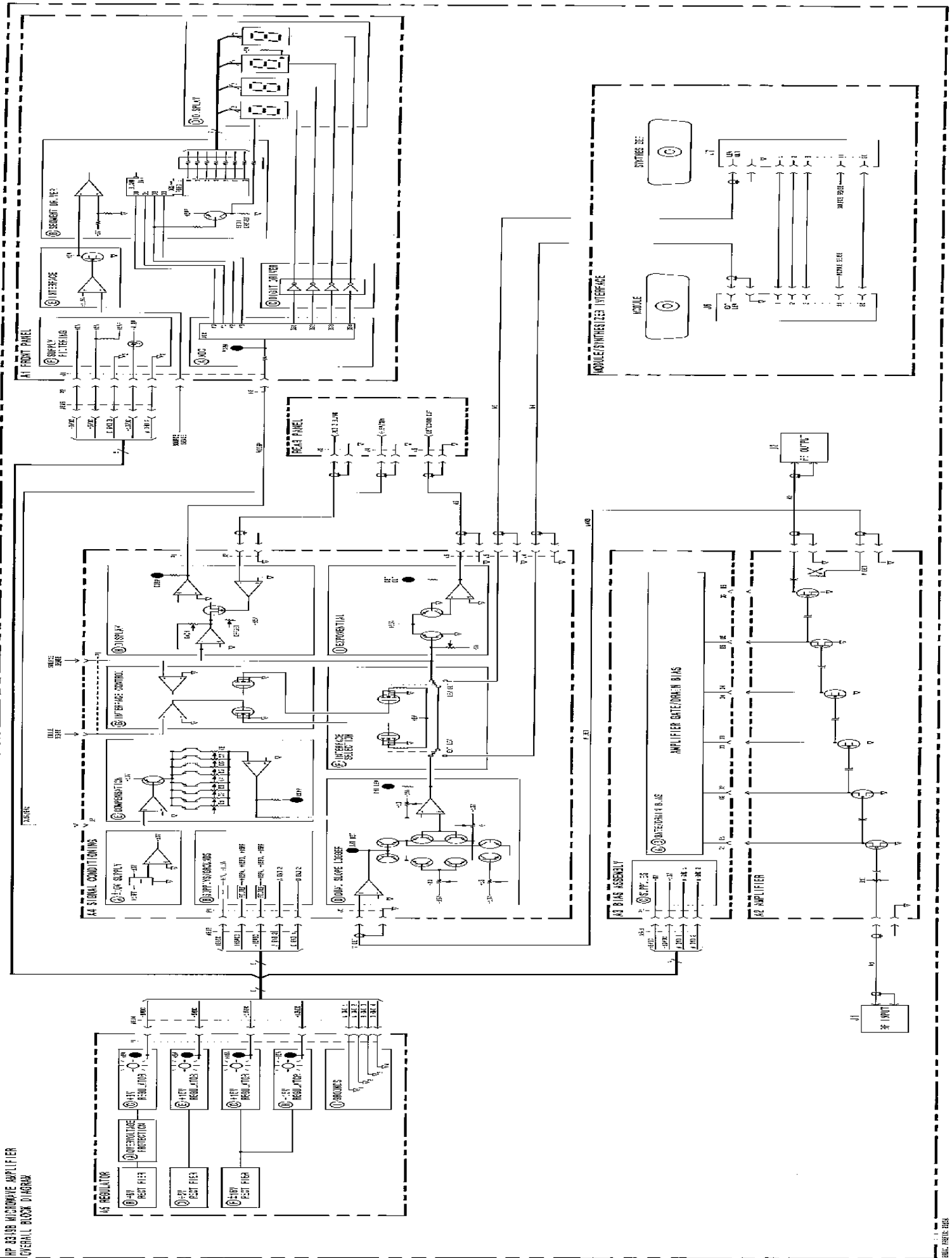

Figure 6-1. HP 8310B Overall Block Diagram  
6-784-3

## **A1 DISPLAY BOARD, CIRCUIT DESCRIPTION**

The purpose of the display board is to display the amount of power at the RF OUTPUT of the HP 8349B. This board is essentially a DC digital voltmeter that measures a tuning voltage (VDISP) from the signal conditioning board and converts it to a front panel power readout.

### **BLOCK A - ADC**

U1, with its associated circuitry, forms a dual ramp,  $3\frac{1}{2}$  digit Analog-to-Digital Converter (ADC) that converts an analog input voltage to a corresponding 8-4-2-1 BCD output once each measurement (Conversion) cycle. This device contains CMOS analog circuitry that provides the operational amplifiers and the comparators required for a complete ADC. U1 also has an internal clock whose frequency is set by R7 at about 66 kHz .

During each measurement cycle, the offset voltages of the internal amplifiers and comparators are compensated for by the internal circuitry of U1.

### **Measurement Cycle**

The ADC (U1) compares the unknown input voltage, VDPM (TP1) to the reference voltage, VREF, to produce the BCD outputs, Y0 through Y3. For a VDPM of +0.2V, which corresponds to +20 dBm, VREF is +2.0V. The reference voltage is set by precision resistors, R5 and R6.

VREF, U1 pin 2, also functions as a reset for the ADC. When pin 2 is switched to VEE, the system is reset by internal circuitry to the beginning of a measurement cycle .

The entire measurement cycle requires slightly more than 16,000 clock periods (approximately 250 ms). Figure 8-4 shows the integrator waveforms at U1 pin 6 for typical positive and negative input voltages, with the cycle divided into six segments as described below.

Segment 1, offset capacitor C3, which compensates for the input offset voltages of the buffer and integrator amplifiers, is charged during this period, and integrator capacitor C4 is shorted. This segment requires 4000 clock periods.

Segment 2, the integrator output decreases to the comparator threshold voltage. At this time, a number of counts equivalent to the input offset voltage of the comparator is stored in the offset latches for later use in the auto-zero process. The time for this segment is variable, but less than 800 clock periods is required.

Segment 3 is identical to segment 1.

Segment 4 is an up-going ramp cycle with VDPM as the input to the integrator. Figure 8-5 shows the equivalent configuration of the analog circuitry of U1. The actual configuration depends on the polarity of the input voltage during the previous cycle.

Segment 5 is a down-going ramp with VREF as the input to the integrator. Segment 5 of the conversion cycle has a time equal to the number of counts stored in the offset storage latches during segment 2. As a result, the system zeroes automatically.

Segment 6 is an extension of segment 5. The time period for this portion is 4000 clock periods. The results of the conversion cycle are determined in this portion.

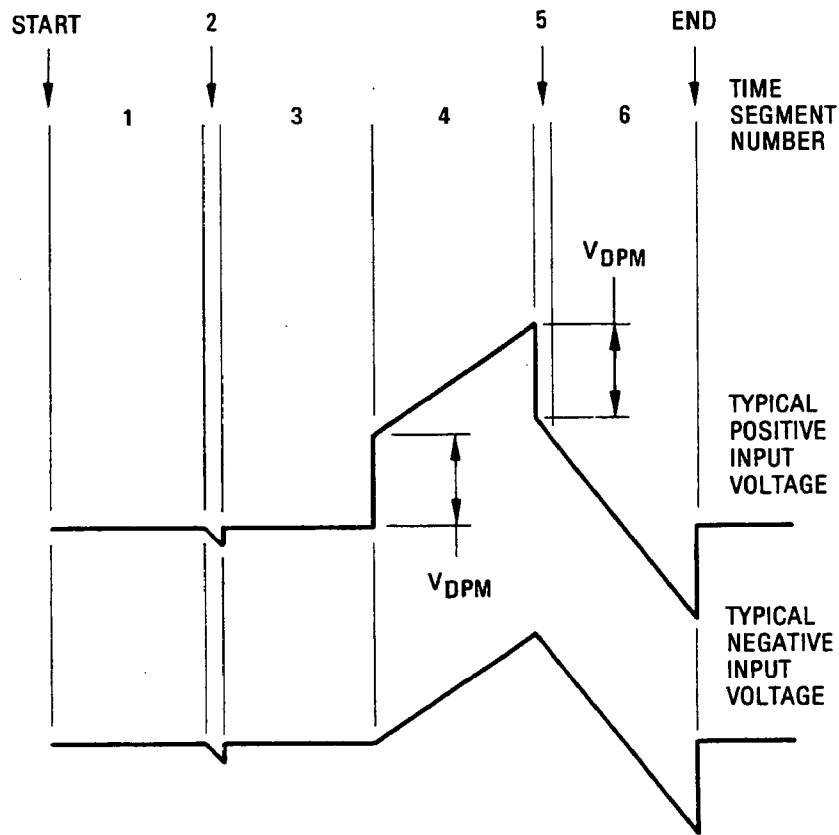

THE TYPICAL  $V_{DPM}$  IS: 0V to 0.2V

Figure 8-4. Integrator Waveforms

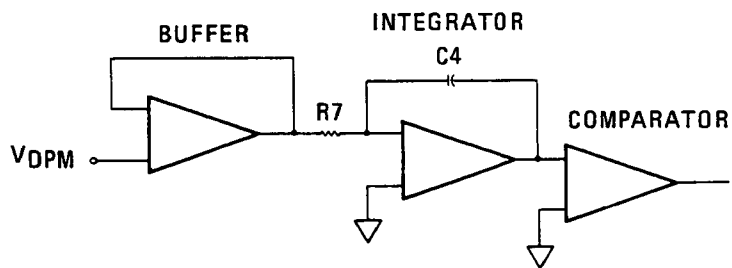

Figure 8-5. Equivalent Analog Circuitry of A1U1

### End of Conversion

The end-of-conversion (EOC) output at U1 pin 14 produces a pulse at the end of each measurement cycle. The pulse width is one-half the period of the system clock, or 7.6  $\mu$ s.

### Display Update

If a positive edge is received at U1 pin 9 (DISPLAY UPDATE) prior to the ramp-down portion, new data will be strobed into the output latches during that conversation cycle. Since pin 9 is wired to the EOC output (pin 14), every conversion is displayed.

## Digit Select

The digit select outputs of U1 are DS1 through DS4, pins 16 through 19. Each select output goes high as the corresponding digit is selected. The most significant digit (the half digit) is turned on immediately after the EOC pulse, followed by the remaining digits in the sequence from the most significant digit (MSD) to the least significant digit (LSD); that is DS1, DS2, DS3, and DS4. A blanking time between two digits of two clock periods is included to ensure that the BCD data has settled. Relative timing among digit select outputs and EOC signals is shown in Figure 8-6.

## BCD Data Outputs

The multiplexed BCD data outputs of U1 are Y3, Y2, Y1, and Y0. During the digit select times DS2 through DS4, the numeric displays, A1DS2 through A1DS4 display the full digits 0 through 9. The most significant digit is displayed on A1DS1 during digit select time DS1. However, only segments b, c, and g of that numerical display are connected, so A1DS1 can display only a "1," a minus sign, or a blank. Note that segment g is not lit by any decoded state of U3.

## Display Section

The Display Section includes BCD-to-Seven-Segment Decoder/Driver U3, resistor package U4, Digit Driver U2 and numeric displays A1DS1 through A1DS4.

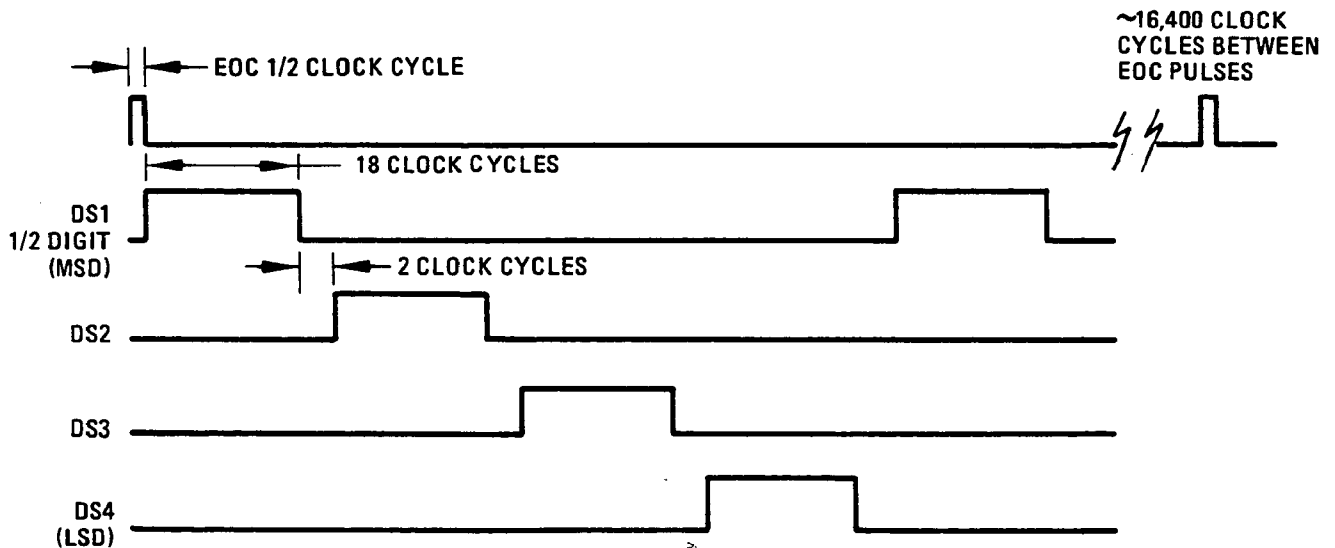
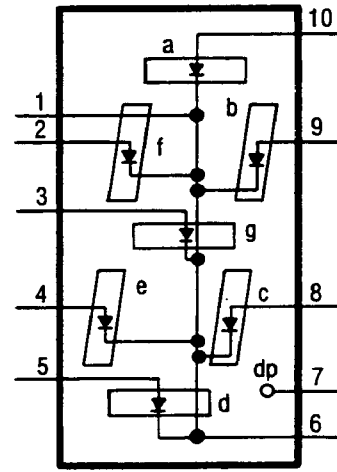
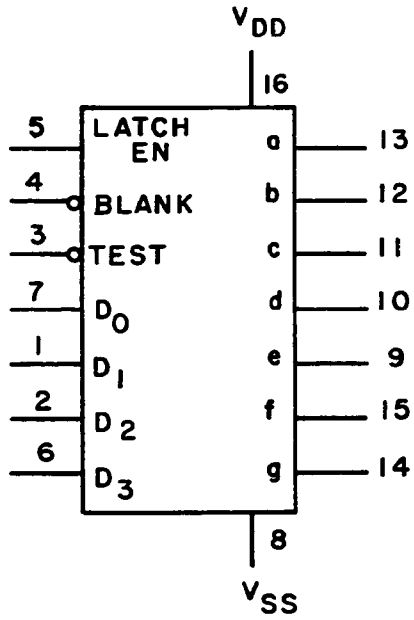
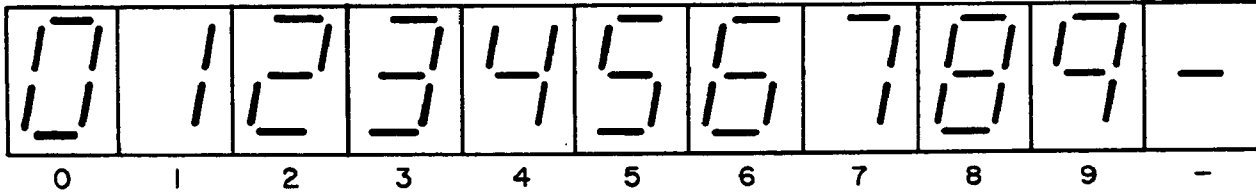

Figure 8-6. Digit Select Timing Diagram



DISPLAY



TRUTH TABLE

Inputs				Outputs							
D <sub>3</sub>	D <sub>2</sub>	D <sub>1</sub>	D <sub>0</sub>	a	b	c	d	e	f	g	Display
0	0	0	0	1	1	1	1	1	1	0	0
0	0	0	1	0	1	1	0	0	0	0	1
0	0	1	0	1	1	0	1	1	0	1	2
0	0	1	1	1	1	1	1	0	0	1	3
0	1	0	0	0	1	1	0	0	1	1	4
0	1	0	1	1	0	1	1	0	1	1	5
0	1	1	0	0	0	1	1	1	1	1	6
0	1	1	1	1	1	1	0	0	0	0	7
1	0	0	0	1	1	1	1	1	1	1	8
1	0	0	1	1	1	1	0	0	1	1	9
1	0	1	0	0	0	0	0	0	0	0	Blank
1	0	1	1	0	0	0	0	0	0	0	Blank
1	1	0	0	0	0	0	0	0	0	0	Blank
1	1	0	1	0	0	0	0	0	0	0	Blank
1	1	1	0	0	0	0	0	0	0	0	Blank
1	1	1	1	0	0	0	0	0	0	0	Blank

Figure 8-7. Segment Driver

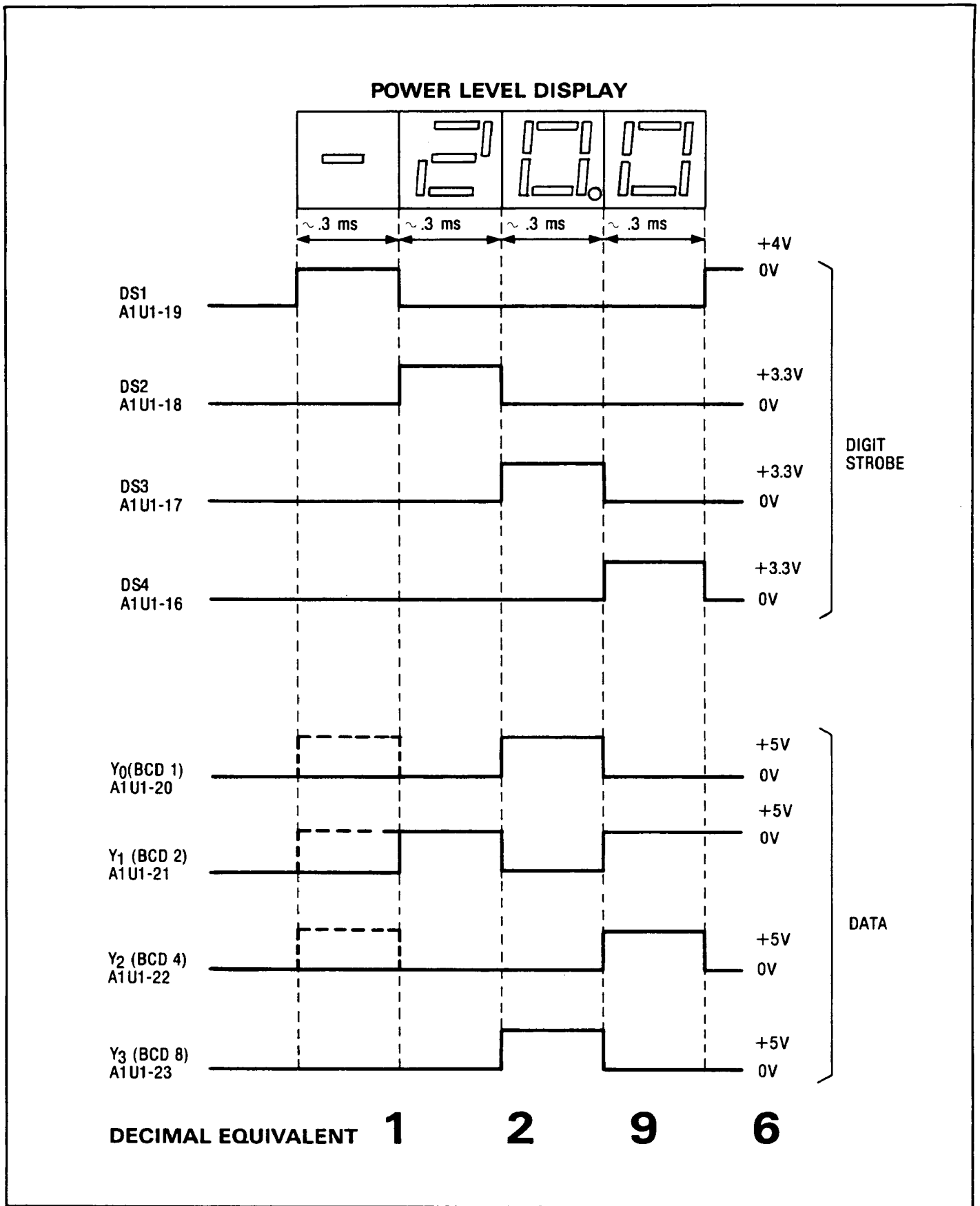

Figure 8-8. Power Level Display Timing

## **BLOCK B - Segment Driver**

At the end of the measurement cycle, the BCD data outputs Y0 through Y3 of U1 are transmitted to Decoder/Driver U3 as data inputs D0 through D3. The decoded outputs, U3 pins 9 through 15, are connected to the appropriate segment anodes to display the decoded numbers in numeric displays A1DS1 through A1DS4.

Figure 8-7 shows the pin connections to U3, the seven segments of a numeric display, and a truth table. The Latch Enable, pin 5, is wired to ground (logic low). The Blanking Input, pin 4, is connected to the TTL output of a comparator. When VDISP is less than  $-0.6V$ , the voltage at pin 4 changes from a logic high to a logic low and the display is blanked. The minus sign and the decimal point remain lit. The lamp test (LT), pin 3 may be grounded at TP3 to test the numeric displays by lighting all seven segments of A1DS2 through A1DS4 and segments b and c (numeral 1) segments of A1DS1. The lamp test does not test the minus sign, segment g.

The minus sign is displayed on A1DS1 only when VDPM is negative, since the voltages corresponding to 0 through  $-2$  dBm are all negative. When VDPM is negative, a logic low at Y2 is applied to the base of Q1, turning Q1 on. A logic high is then applied to A1DS1 pin 3, which is the anode of segment g, and the minus sign is lit.

## **BLOCK C - Digit Driver**

Digit Driver U2 is a Darlington transistor array that comprises seven Darlington pairs. Each Darlington pair is shown as an inverter on the schematic, and a schematic of the actual configuration is shown in the schematic notes.

The digits are selected in sequence, starting with the most significant digit (displayed on A1DS1). A logic high on a digit-select output of U1 (DS1 through DS4) is inverted through U2 to place a low on the segment cathodes, pin 6, of the corresponding numeric display A1DS1 through A1DS4 (pins 1 and pin 6 are connected internally; the schematic indicates the external connections). Since the displays are of the common-cathode type and the segment anodes corresponding to the decoded numbers receive logic highs from U3, the segments are lit to display the power corresponding to VDPM.

## **BLOCK D - Display**

The POWER LEVEL display readout consists of four 7-segment numeric displays, A1DS1 through A1DS4. A1DS1, the most significant digit (MSD), is connected to display only the numeral 1 or the minus sign (which is lit when VDPM goes negative). The decimal point is connected to the  $+5V$  supply through R15 and is always lit.

Figure 8-8 relates the decoded states of Y0 through Y3 to the POWER LEVEL readout for digit select times DS1 through DS4. Note that Y0 through Y2 might be either high or low during DS1 since the decoded states 0, 3, 4, and 7 are all displayed as "1," explained in the discussion of MSD codes.

Only three segments of the MSD display A1DS1 are connected because of limited logic in the ADC, U1. As a result, four decoded outputs of Segment Driver U3 cause A1DS1 to blank, and four decoded outputs cause A1DS1 to display numeral 1. The anodes of segments b and c (the numeral 1) are driven by U3, while segment g (the minus sign) is driven by Q1.

During digit select time DS1 (Figure 8-7), when A1DS1 is driven, outputs Y3 through Y0 of the ADC might be decoded as any one of eight states. The following states cause A1DS1 to be blanked.

Y3	Y2	Y1	Y2	Decoded State	A1 Display
1	0	1	0	10	Blank
1	0	1	1	11	Blank
1	1	1	0	14	Blank
1	1	1	1	15	Blank

Since only segments b and c of A1DS1 are connected, the decoded 0, 3, 4, and 7 all appear as 1 shown in Figure 8-8.

Y3	Y2	Y1	Y2	Decoded State	A1 Display
0	0	0	0	0	1
0	0	1	1	3	1
0	1	0	0	4	1
0	1	1	1	7	1

## BLOCK E - INTERFACE

The source sense control line (TTL pull up front the A4 Signal Conditioning Board) provides display control during millimeter wave applications; the HP 8349B display is blanked and shows all minus signs when the synthesizer interface is connected.

When source sense is a logic low (Synthesizer Interface Cable Connected), the TTL comparator U5 provides the necessary voltage levels for display control. U5A and Q2 turn off, in turn, VDISP is gated off. U5B and Q3 turn on providing a scaled VDPM for the **U1-ADC**. Comparator U5A shifts states giving a logic low at the blanking input of decoder U3, blanking the display. U5C and Q4 turn on providing a TTL high to the g segments of the display, therefore biasing on all the minus signs across it. CR4 provides back bias protection for U3 decoder output on pin 14.



## **A1 DISPLAY BOARD, TROUBLESHOOTING**

### **Basic Checks**

Verify that +8V, +5V, +5 VF, +1.5V, -15V and -4.9 V power supply voltages are present on the assembly. The DVM should be referenced to D GND (A1TP2) when checking the +5V and +5 VF supply voltages or A GND 2 when checking the other supply voltages.

Verify that VDISP is present on the assembly. Note that VDISP should vary from 0V for an RF OUTPUT of 0 dBm, to approximately 5.0 V for an RF OUTPUT of 20.0 dBm. For the same output power range, VDPM should vary from 0V to 0.2V.

Ground TP3 LT, to A GND 2 and verify that all segments of A1DS2 through DS4 are lit. If this does not occur, suspect either the displays or A1U3. Note that the minus sign is not lit during this test. It is only lit when VDISP goes negative.

Ground the source sense control line and verify the display shows minus signs only. If not, check each section of comparator U5 to determine the fault.

# A1

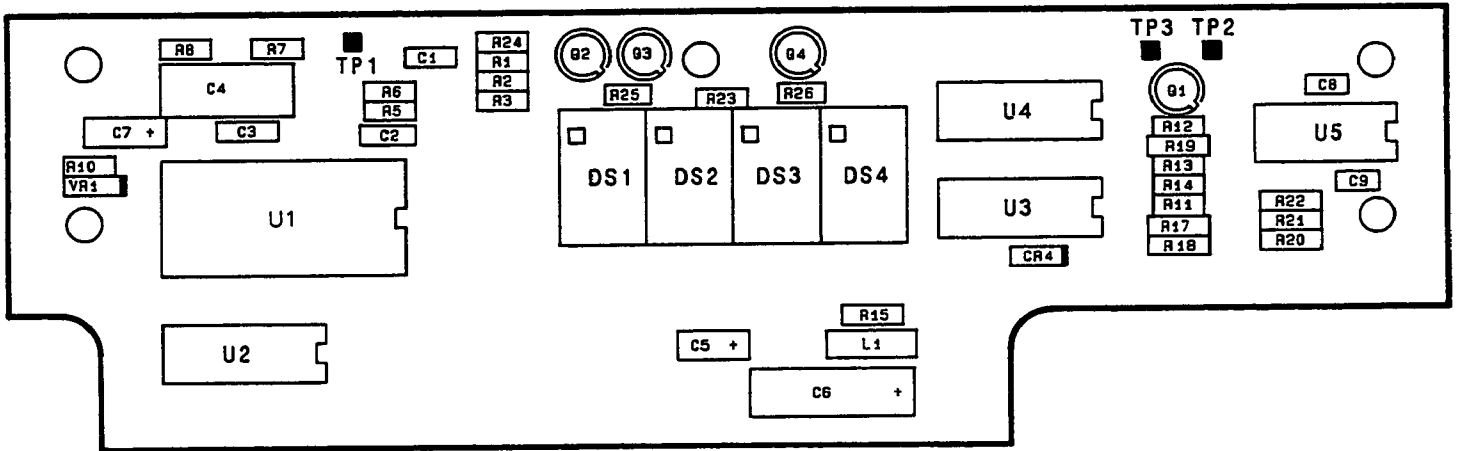
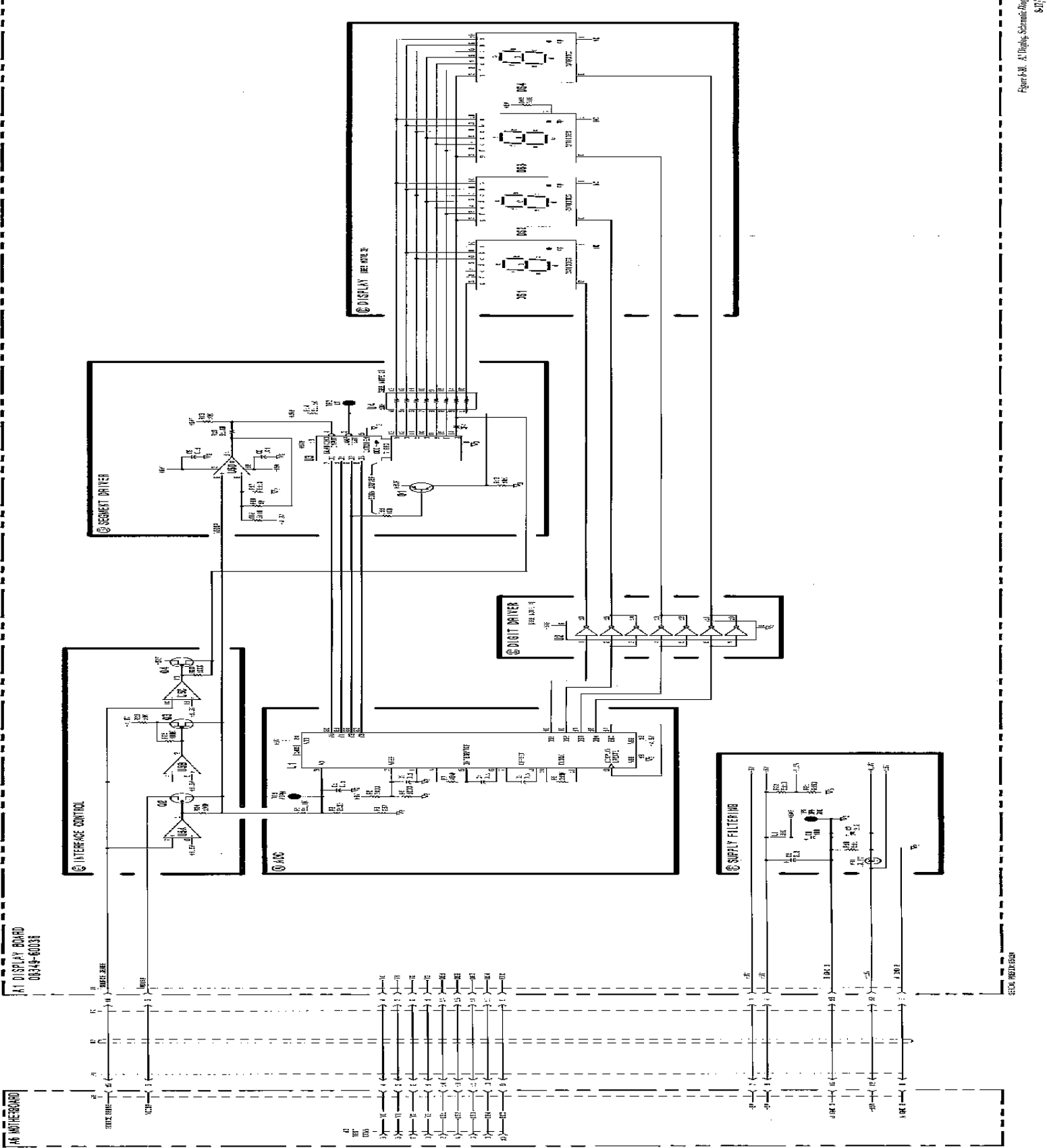

Figure 8-9. A1 Display, Component Locations



## **A2 AMPLIFIER AND A3 BIAS BOARD, CIRCUIT DESCRIPTION**

The A3 bias board provides independent drain and gate bias for the eight FETs in the A2 amplifier. This assembly is powered by the +8V and -10V power supplies.

The A2 amplifier contains eight FETs which amplify the RF input signal. At the amplifier's output stage, a portion of the RF OUTPUT power is coupled off, detected, and then sent as VDET to the A4 signal conditioning board. On the A4 assembly, VDET is converted to a signal (VDISP) which is used to drive the A1 display board where the RF OUTPUT power is displayed in dBm on the POWER LEVEL display.

### **BLOCK A - DRAIN BIAS**

The Drain Bias for the FETs in the amplifier is provided by six post regulators whose voltages is set by select resistors, R1 through R12, which are connected to a terminal strip on the bias board. Q1's and Q2's collector-to-emmitter voltage is set by resistors R1, R2, and R3, R4 respectively. Resistors R37 and R38 are current limiting resistors which protect the FETs in the first two stages of the amplifier in the event of line transients or an overvoltage condition.

Q3 through Q6 are configured as Vbe multipliers. The collector-to-emitter voltage is a non-integer multiple of the Vbe diode drop where  $V_{ce} = 1 + R_a/R_b$ ;  $R_a = R_5$  and  $R_b = R_6$  for transistor Q3.

R25 through R30 are emitter current sense resistors which can be accessed from test point connector J1 to measure the drain currents. The drain voltages can also be measured at the test points on connector J1.

### **BLOCK B - GATE BIAS**

The FET gate bias for stages 3 through 6 is developed by the divider network created by the combination of a fixed resistor and potentiometer, R40 through R43, respectively. The gate bias for stages 1 and 2 is fixed at about zero volts through chassis ground and resistors R13 and R14.

### **BLOCK C - SUPPLIES/GROUNDS**

The instrument has two analog grounds; A GND 1, a high current ground, and A GND 2, a low current ground. Both grounds are connected to chassis ground through the screws which secure the A3 bias board to the microcircuit.

For troubleshooting, A GND 1, A GND 2, and the power supply voltages can be accessed at the test point connector J1.

## A2 AMPLIFIER AND A3 BIAS BOARD, TROUBLESHOOTING

**NOTE:** The A2 amplifier is extremely static sensitive. Any troubleshooting of this assembly or the A2 bias board should be done at an anti-static work station.

**NOTE:** While troubleshooting the A2 amplifier and A3 bias board, the chassis ground connection must be maintained. If the assemblies need to be removed from the instrument for troubleshooting, they should be placed into their service position. Refer to the Service Position Installation Procedure.

### Basic Checks

Verify that +8V and -10V power supply voltages are present. The +8V supply can be measured by probing across A3J1 pin 2 and A3J1 pin 1 (A GND 1). The -10V supply can be measured by probing across A3J1 pin 40 and A3J1 pin 1.

Verify that RF INPUT and RF OUTPUT connectors and cabling are not defective. Measure the output power directly at the output of A2 to verify that W2 or J2 are not at fault. Measure the input power at the output of W1 to verify that W1 or J1 are not at fault.

### Bias Checks

The following tests will determine if the biasing to each stage of the amplifier is correct. If an incorrect bias is found, further troubleshooting will be required to determine if the biasing problem is due to the bias circuit on the A3 bias board or the A2 amplifier.

With the DVM referenced to A GND 2 (A3J1 pin 39), measure the drain voltages at the points listed below. The measured values should be within  $\pm 3V$  of the values given.

- D1 (A3J1 pin 35)- +4.0V
- D2 (A3J1 pin 31)- +4.0V
- D3 (A3J1 pin 27)- +5.5V
- D4 (A3J1 pin 23)- +5.5V
- D5 (A3J1 pin 19)- +6.5V
- D5 (A3J1 pin 15)- +6.5V

Attached to the Transistor Block is a label which gives the bias current, ID3, ID4, ID5, and ID6, required by the amplifier (see Figure 8-11). ID3 through ID6 are the bias currents for the A2 amplifier's third through sixth stage and can be measured across R27, R28, R29, and R30 respectively. Since these resistors are 1 Ohm sense resistors, the voltage drop across these resistors corresponds to the bias current. For example, the bias current shown for ID3 in Figure 8-11 is 86 mA. To verify that stage 3 of the amplifier is biased correctly, connect DVM HIGH to A3J1 pin 29 and DVM LO to A3J1 pin 27. The DVM should indicate 86.0 mV +4.3 mV which corresponds to 86 mA +4.3 mA. The +4.3 mV (mA) bias variation corresponds to +5% bias range over which the amplifier may be set.

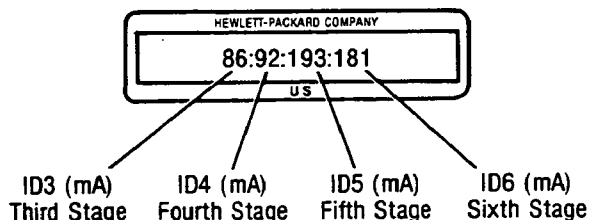

Figure 8-11. A2 Amplifier Bias Currents Label

Verify that the amplifier's bias currents are correct by measuring across the test points listed below.

ID3 - A3J1 pin 29 to A3J1 pin 27  
ID4 - A3J1 pin 25 to A3J1 pin 23  
ID5 - A3J1 pin 2:1 to A3J1 pin 19  
ID6 - A3J1 pin 17 to A3J1 pin 15

If the bias currents are found to be incorrect, further troubleshooting will be required to determine if the bias circuitry or amplifier is at fault. If Q3, Q4, Q5, or Q6 is found to be defective, follow the replacement procedure given.

### **Q3, Q4, Q5, and Q6 Replacement Procedure**

Upon replacement of Q3, Q4, Q5, or Q6, verify that the bias current for the stage in which the transistor was replaced is correct (see Bias Checks above). If the bias current is incorrect, adjust the appropriate potentiometer (see below).

ID3 - Adjust R40  
ID4 - Adjust R41  
ID5 - Adjust R42  
ID6 - Adjust R43

Verify that the bias currents are correct.

### **Service Position Installation Procedure**

1. Turn the HP 8349B LINE switch off and disconnect the line cord.
2. Remove the top and bottom covers (only the rear screw on the top needs to be removed to release the top cover).
3. Remove the four screws securing the heat sink on which the A2 amplifier and A3 bias board are mounted (see Figure 8-12a).
4. Remove the two rear screws securing the heat sink on which the A5 regulator board is mounted (see Figure 8-12a).
5. Loosen the two screws securing the center support of the HP 8349B (see Figure 8-12c). Slide the rear panel away from the front panel.
6. Disengage the A3 bias board from the motherboard. Remove the A2 amplifier, A3 bias board and heat sink from the instrument. Disconnect the detector cable, W3, from the A2 amplifier.

**NOTE:** When sliding the rear panel forward in step 7, ensure that the LINE switch is reinserted through the front panel.

7. Slide the rear panel toward the front panel and reinstall the two rear screws which secure the heat sink on which the A5 regulator board is mounted. Securing this heat sink to the rear panel reconnects chassis ground.
8. Connect the extender board, HP P/N 08349-60058, to A6J1.
9. Mount the extender bracket (HP P/N 08349-00005) to the front panel using two of the screws removed in step 3. Connect the A3 bias board to the extender board installed in step 8 and mount the heat sink to the extender bracket (see Figure 8-12d). Reconnect the detector cable, W2, to the A2 assembly.

10. Ensure the LINE switch is off before reconnecting the LINE cord.
11. Reverse this procedure when reinstalling the A2 amplifier, A3 bias board and heat sink.

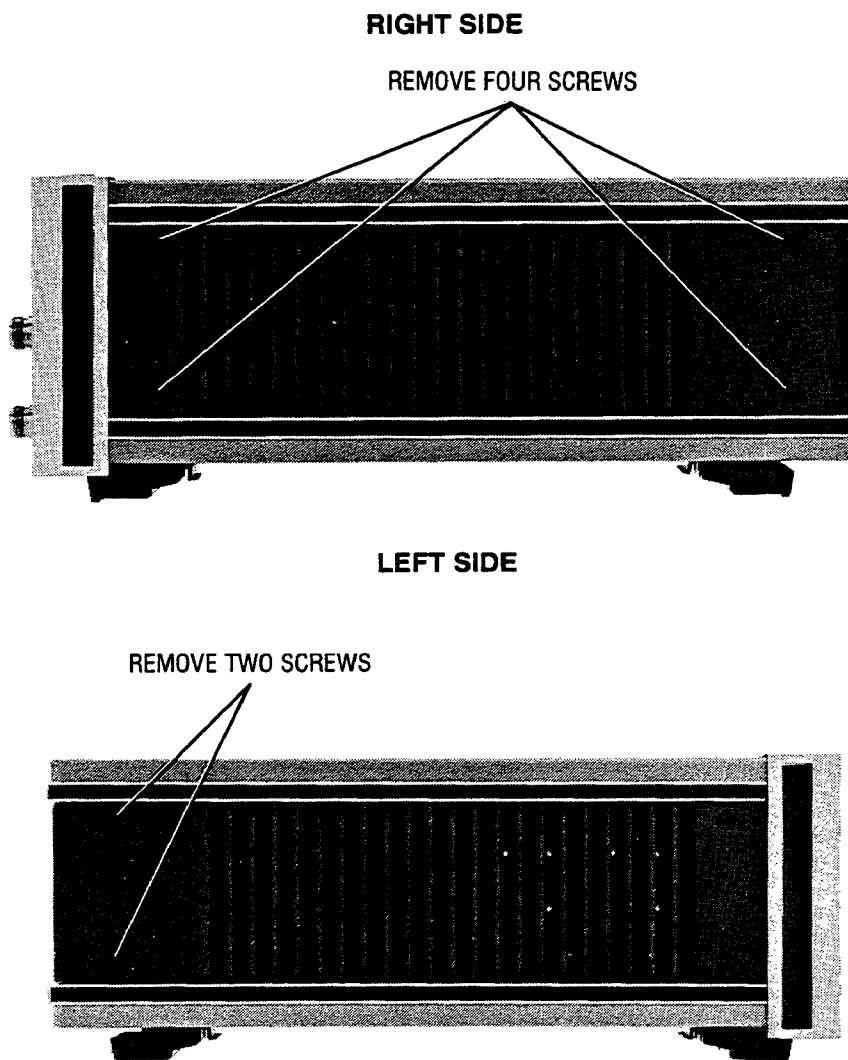

*Figure 8-12. Service Position Installation (1 of 2)*

**TOP SIDE**

LOOSEN TOP AND BOTTOM SCREWS  
(bottom screw not visible)

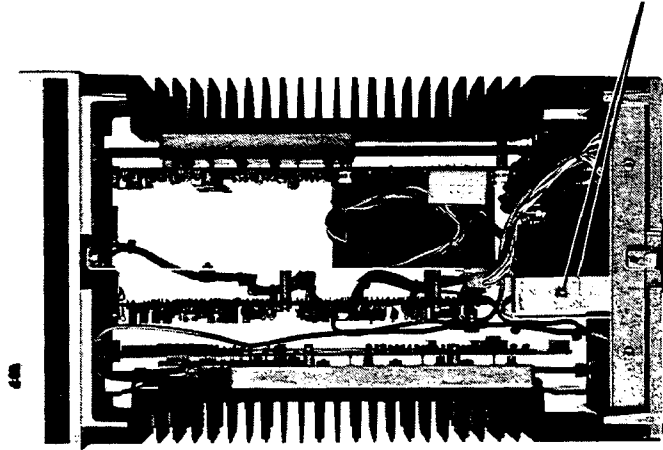

**A2 AMPLIFIER, A2 BIAS BOARD, AND HEAT SINK IN SERVICE POSITION**

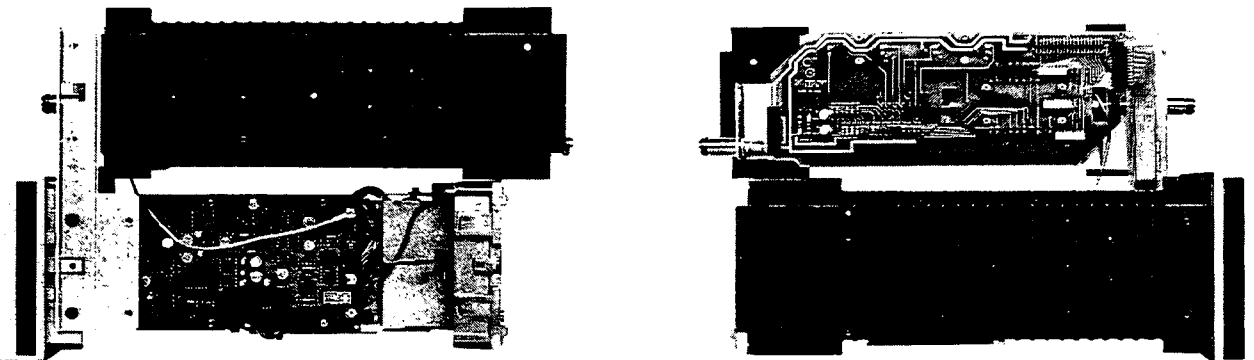

VIEW OF RIGHT SIDE

VIEW OF LEFT SIDE

*Figure 8-12. Service Position Installation (2 of 2)*



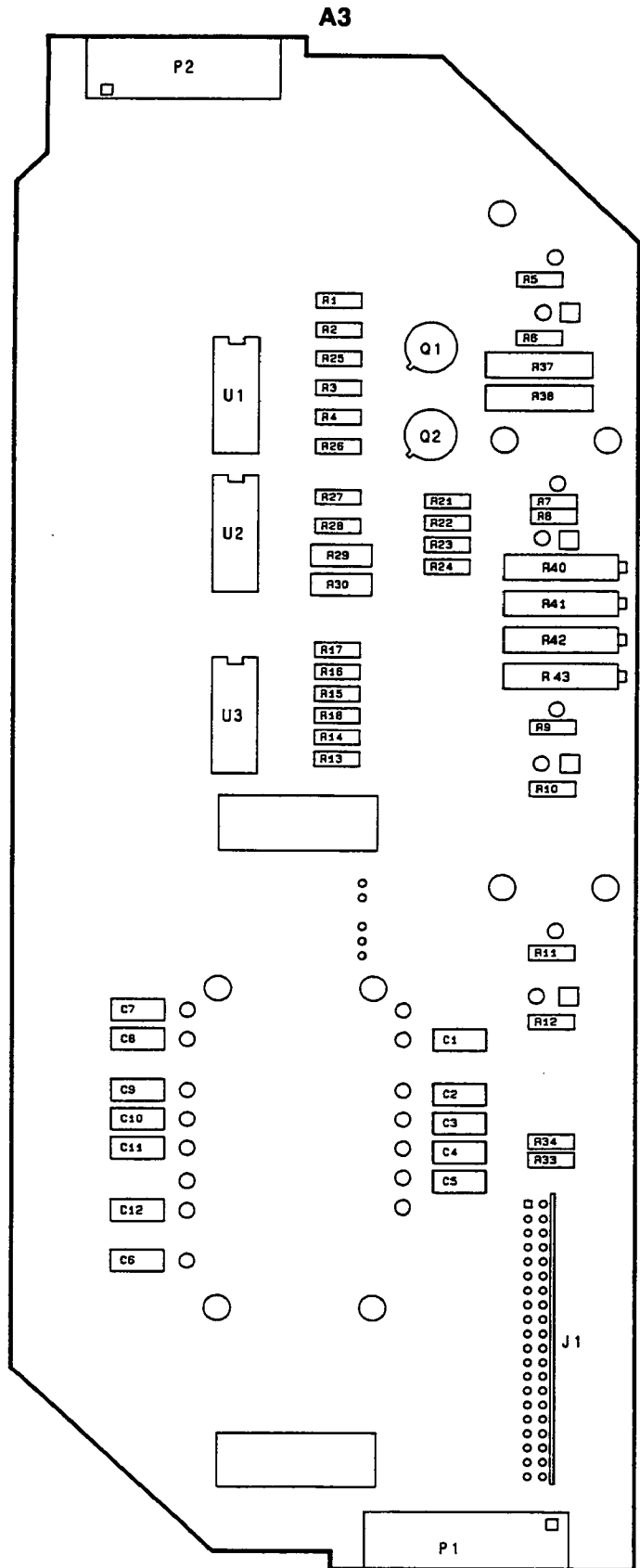
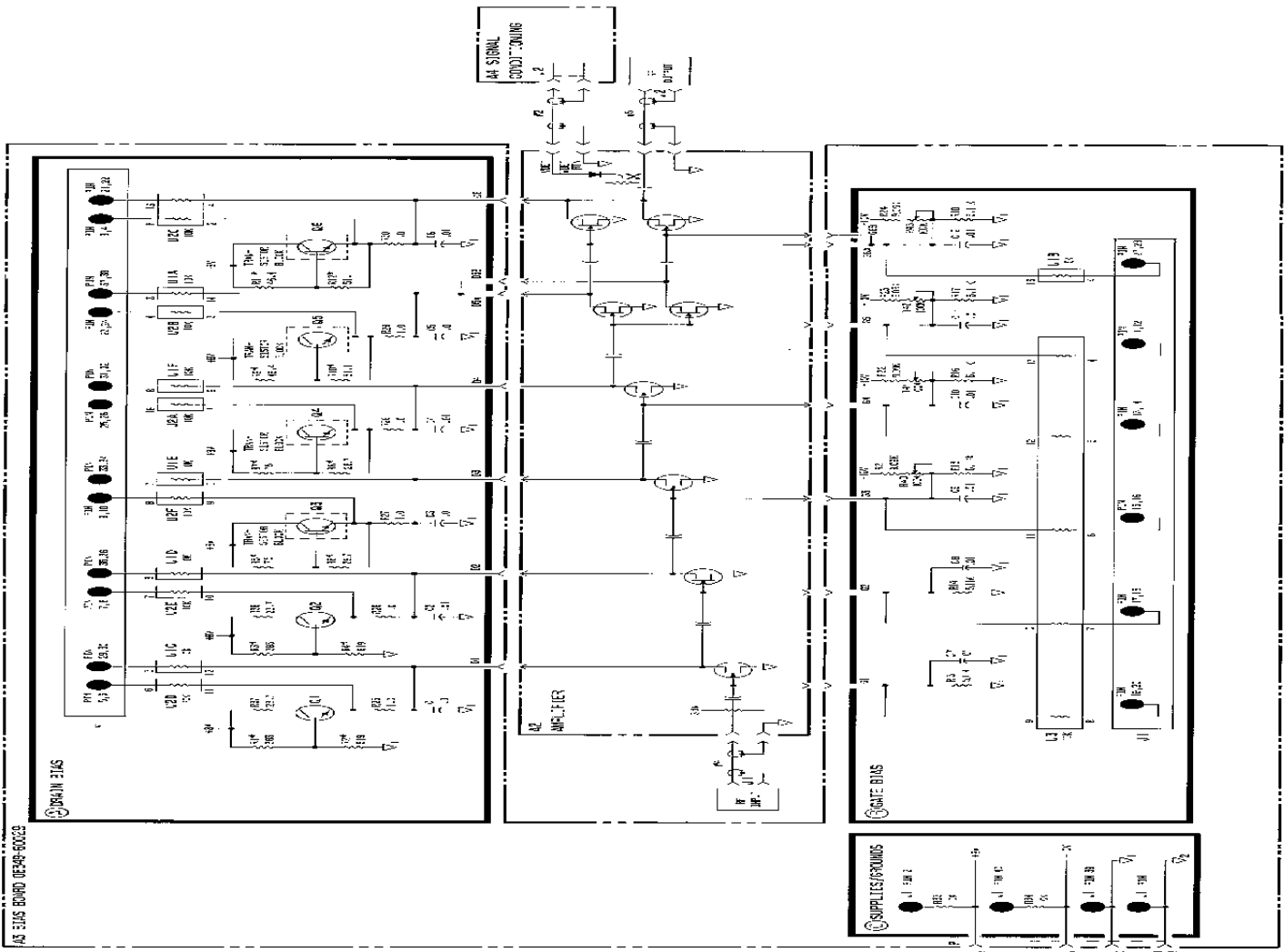

Figure 8-13. A3 Bias Component Locations



AS BIAS BOARD DS-94-60023

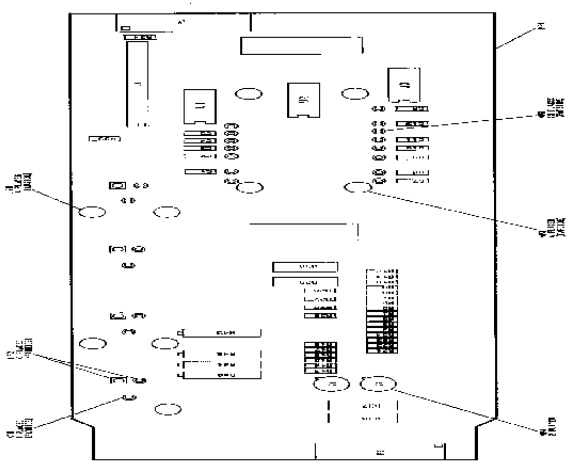
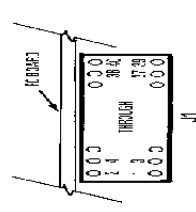

Figure 6-11. A1 Bias Board Component Locations

**NOTES**

1. VALUES OF RESISTORS INDICATED IN SCHEMATIC DIAGRAMS ARE CONSIDERED MINIMUMS AND YOU SHOULD INCREASE THEM UPWARD AS NECESSARY.
2. IN THE SCHEMATIC DIAGRAMS:



3. THE VALUES OF RESISTORS INDICATED IN SCHEMATIC DIAGRAMS ARE CONSIDERED MINIMUMS AND YOU SHOULD INCREASE THEM UPWARD AS NECESSARY.

## A4 SIGNAL CONDITIONING BOARD, CIRCUIT DESCRIPTION

The main function of the A4 signal conditioning board is, as the name implies, to condition and route signals. The input signals are:

- VDET from the A2 amplifier assembly.
- 0.5V/GHz from a rear panel input or synthesizer interface J7.
- MM Module/Synthesizer sense lines from either the A6 motherboard or front/rear panel connectors.
- Power supply voltages from the AS regulator assembly.

There are two output signals generated by the signal conditioning board, VDISP and DET OUT. VDISP is used by the A1 display board to display the HP 8349B peak RF output power in dBm. DET OUT is connected directly to a rear panel BNC output which can be used to drive the external automatic leveling control (ALC) circuitry of an RF source.

### BLOCK A - $\pm 10$ VDC

Regulator U4 and operational amplifier U1 provide regulated  $\pm 10$  Vdc reference voltages for the flatness compensation circuitry BLOCK E and the dual slope log amplifier BLOCK B. U1 acts as an inverting amplifier with unity gain to provide the  $-10$  Vdc reference. The current required by the loads on the  $-10$  Vdc supply is provided by the  $-15$  VR power supply through A4R29.

### BLOCK B - DUAL SLOPE LOG AMPLIFIER

VDET from the internal detector on the A2 amplifier assembly is buffered and amplified (x5) by U8. U8 provides a high impedance input (INT DET) to the log amplifier to prevent loading of the A2 internal detector. U9, Q9 and Q2 form the dual slope log amplifier with Q11, Q1 and U1B configured as an adjustable current source to provide base currents IB1 and IB2. (See log converter description below.)

RT1 provides thermal compensation for the sensitivity drift of the A2 internal detector. The inverse compensation modifies the log amplifier base currents through amplifier U1B and matched transistor pair Q1A and Q1B.

The dual slope log amplifier signal is amplified (x10) and buffered by U5 and U14. U5 is also the summing junction for the flatness compensation circuitry. BLOCK E. The output of U14 is a compensation signal (INT LEV) which rises at a rate of 60mV/dB (with 0V = 0 dB as the reference) to a maximum of 1.200V (= 20 dB).

RT2 provides inverse thermal compensation for the log amplifier output. The log amplifier conversion equation is:

$$V_{out} = KT/q \text{ LN}(I_{in}/I_{out})$$

Note that it is directly proportional to temperature.

Resistor A4R36 provides a 50 ohm impedance to an external synthesizer through relay K2 and the synthesizer connector J7.

Adjustments on the A4 signal conditioning board are listed below with the reference designation adjustment name and functional description.

A4R14 (-20) The bias control for log amplifier input stage U9 Q2 and Q9.

A4R34 (-10) The gain control for output amplifier U5 which sets maximum output level.

A4R21 (0) The bias control for log amplifier Q2 which sets emitter bias for the matched transistor pair.

A4R23 (+15) The adjustable current source bias control which sets IB1 and IB2 current levels.

These A4 adjustments are referenced in Section 5, "Adjustments" under "Dual Slope Log Adjustments."

## Log Converter Description

Diode detectors characteristically exhibit two distinct regions of operation. At low power levels ( $<0$  dBm) the detectors are in their "square law region." In this region the detector's output voltage is proportional to RF power. At high power levels the log converter output voltage is proportional to the square root of the RF power. The purpose of the log converter is to convert the detector's output voltage into a DC voltage which corresponds to RF power in dBm. For the log converter to accomplish this, the log converter outputs over its entire range a voltage proportional to the logarithm of the input voltage. However when the detector is operating in its "linear" region the log converter's gain is twice that of when the detector is operating in its "square law" region. This doubling of gain in the "linear" region ensures that the log converter output is logarithmically related to its input over the entire range.

Figure 8-15 illustrates a simplified single slope log converter. The "log" function is accomplished by Q1A using the transistor characteristic that the collector current is the exponential of the base-to-emitter voltage. U1 amplifies the detector voltage sinking the collector current of Q1A until it equals the input current developed by  $V_{in}$  across  $R_{in}$ . Q1A's emitter voltage is then log of the input voltage which passes through Q1B (wired as a diode) to the output.

To implement a "dual slope" log converter a second pair of transistors with bias currents is added as in Figure 8-16. Bias currents IB1 and IB2 are constant and nearly equal. Q1A and Q1B carry the logging current  $i_{in}$  and Q2A and Q2B carry IB1 and IB2. For low power levels (square law region) assume  $i_{in} \ll IB1$  and  $i_o$  (offset current)  $\ll IB2$ . Q2A and Q2B are then carrying essentially identical currents and their base-to-emitter voltages are identical. Also the emitter of Q1A is at the same voltage as the emitter of Q1B and the circuit acts like the single-slope logger of Figure 8-15. For high power levels (linear region)  $i_{in} \gg IB1$ . Q1A and Q2A now carry the same current  $i_{in}$  (IB1 can be ignored) and the base voltage of Q2A varies twice as much as the emitter of Q1A. Thus the gain of the logger is doubled when the detector is in its linear region and the log converter outputs a voltage proportional to a detected RF power over a wide range of power levels.

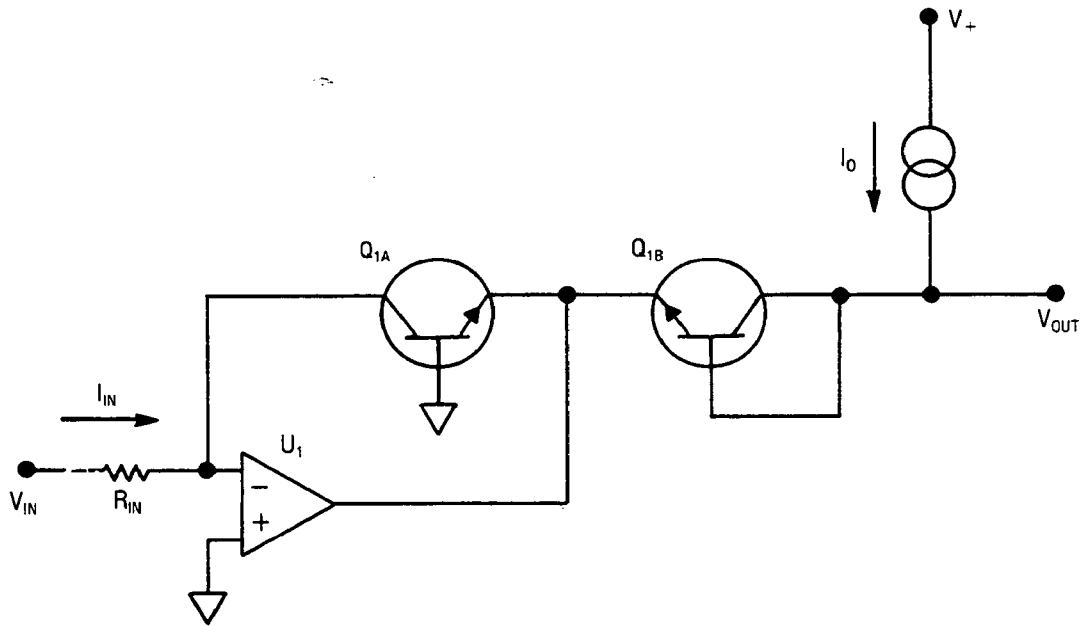

Figure 8-15. Single Slope Log Converter Diagram

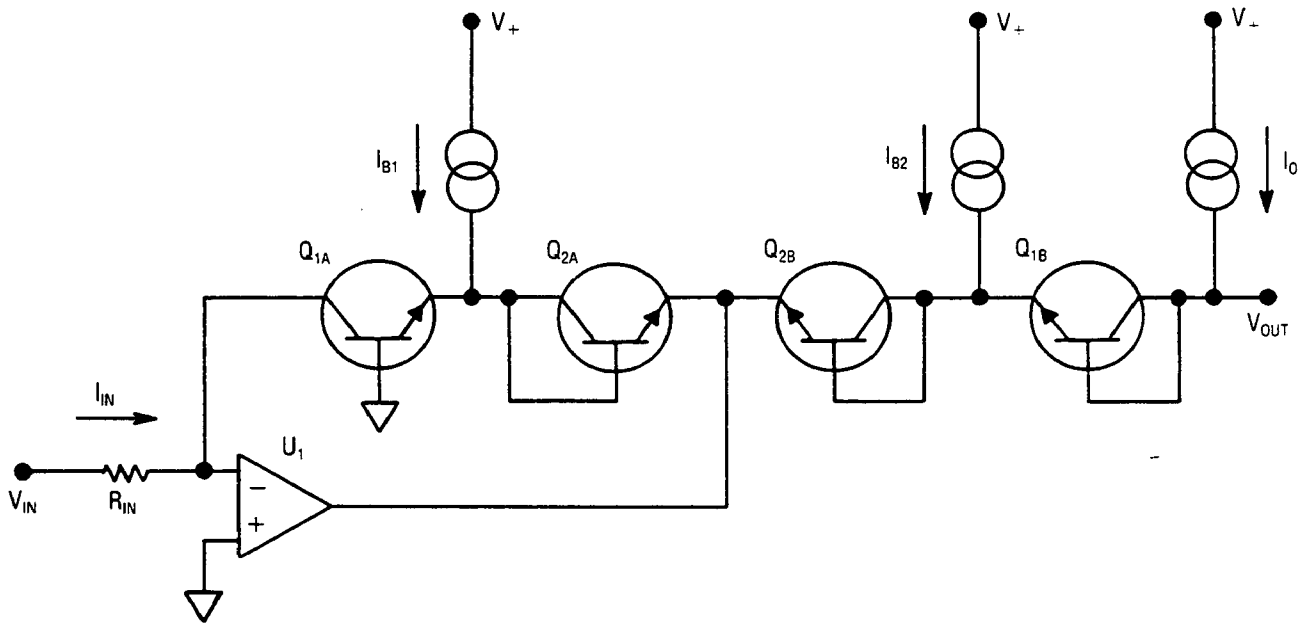

Figure 8-16. Dual Slope Log Converter Diagram

## **BLOCK C - INTERFACE SECTION**

### **BLOCK F - INTERFACE CONTROL**

Comparators U6A and U6B are controlled by the source sense and module sense lines (part of module/synthesizer interface), which are active when either a millimeter (MM) source module or synthesizer are connected to the interface. The comparators activate FET devices Q3, Q4, Q7, and Q8 which control relays K1 and K2.

The relays provide proper ALC signal and ground routing depending upon whether a source module/synthesizer (or both) are being used. The output of the dual slope log amplifier (INT LEV) can be exponentially amplified (DET OUT) or sent to the synthesizer interface coaxial output as a logged output (LEV OUT) depending on the relay activated.

### **BLOCK D - DISPLAY DRIVER**

U12 and U13 provide two stages of amplification to create a "peak detected" signal that maintains a constant display of peak RF power on the front panel power level display. Amplifier U11 is the final amplification stage before the signal (VDISP) is routed to the A1 assembly for processing.

The GAIN (A4R79) and OFFSET (A4R81) adjustments provide bias control for the display driver amplifier stages. They adjust for the minimum and maximum output signals to the front panel power level display.

Comparator U6C and FET switch Q5 configure the display hold circuitry that maintains a constant display on the front panel during an RF source's retrace and bandswitch points. They are active only when the rear panel POS Z BLANK input is connected to the source's positive Z-axis blanking output.

### **BLOCK E - FLATNESS COMPENSATION**

The frequency flatness compensation circuitry is referenced to the RF source output frequency by the 0.5V/GHz input connection. The 0.5V/GHz input can be connected either from a rear panel BNC connector or the synthesizer interface connector J7.

Amplifier U10B and Q10 provide the required bias current for transistor arrays U2 and U3. The 0.5V/GHz input signal drives amplifier U10B. Q10 provides the bias current. Transistor arrays U2 and U3 together with adjustments A4R60 - A4R67 (C8 - C1) form the staged frequency flatness compensation circuits.

When the 0.5V/GHz input is 0.00 volts the output current of transistor Q10 is maximum. The bias resistors then drive the emitters of U2 and U3 more positive causing U2 and U3 to "cut-off". The inputs of amplifier U10A are now matched and the output is 0.00 volts (no compensation).

As the 0.5V/GHz input voltage increases the biasing of U2 and U3, an active mode is staged across the transistor arrays. Thus, the C1 stage is biased active first and controls amplifier U10A output at the lowest frequency. As each stage is biased active, the output of U10A will change in stages. The output is compensated and related directly to the RF source frequency.

Amplifier U10A output (COMP) is summed with the dual slope log amplifier output stage to provide an output (INT LEV) which is flat relative to frequency. Adjustments C1 - C8 are used to adjust the collector bias currents (see Section 5, "Flatness Compensation Adjustment").

Buffer amplifier U6D output is routed to the module interface connector J6 and provides the 0.5V/GHz signal to the MM source module.

## BLOCK G - EXPONENTIAL AMPLIFIER

The exponential amplifier circuitry Q6 and U7 essentially duplicate a crystal detector. They provide a linear output ALC signal to the rear panel output, DET OUT. The input signal, INT LEV, varies from 0.00V to 1.20V (0 dBm - 20 dBm) at a rate of 60mV/dB. Input amplifier Q6 provides a differential output current which simulates the output of a detector. Adjustment A4R89 (DET OUT) provides bias adjustment for the overall amplifier circuitry. Output amplifier U7 provides isolation, as well as, amplification.

## BLOCK H - POWER SUPPLY FILTERS

The  $\pm 15$  Vdc power supplies are filtered into six supplies, +15 VA, +15 VD, +15 VR. Each supply is coupled to three different ground planes A, D and R, respectively. Millimeter interface selection and control require different supply and ground references to allow continuous reference whenever the HP 8349B is used in amplifier, synthesizer/amplifier or millimeter module applications.

## A4 SIGNAL CONDITIONING BOARD, TROUBLESHOOTING

### Basic Checks

Verify that +1.5 V, +8 V, +15 V and -15 V power supply voltage are present and correct on the assembly. The +15 V supply can be checked at A5TP3, -15 V at A5TP6 with a ground reference at A5TP1. The +1.5 supply (generated through a voltage divider circuit) may be checked at the junction of A4R1 and A4R2, or pin 12 of A4U6.

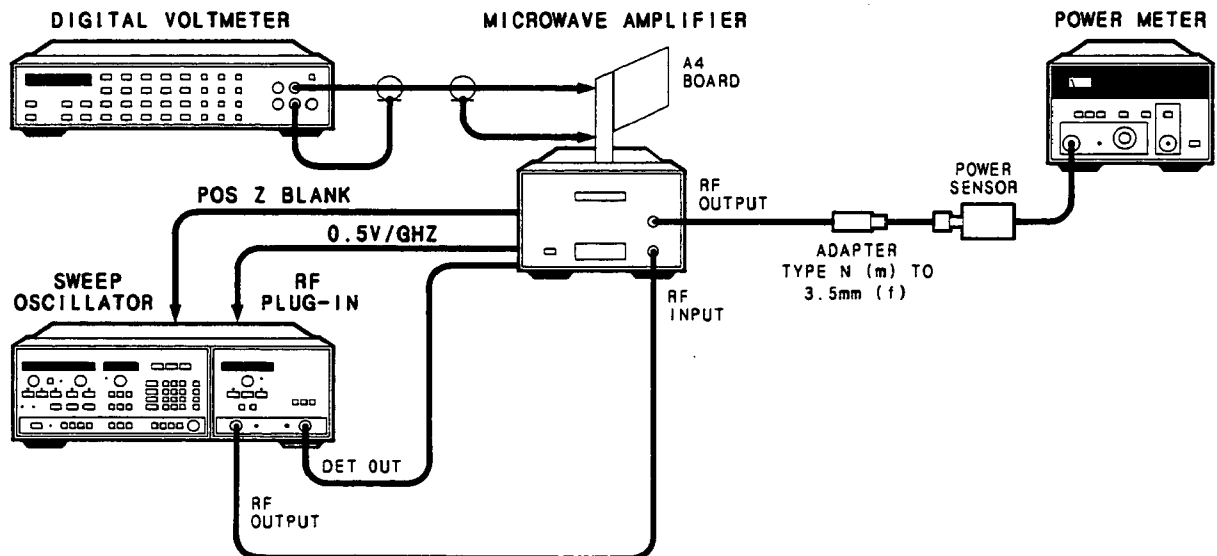

Figure 8-17. Troubleshooting Test Setup

## Equipment Required

Sweep Oscillator .....	HP 8350B
RF Plug-in .....	HP 83590A
Digital Voltmeter .....	HP 3456A
Power Meter .....	HP 436A
Power Sensor .....	HP 8485A
Extender Board .....	HP P/N 08349-60059

## Procedure

1. Remove top and bottom covers from the HP 8349B.
2. Connect the equipment as shown in Figure 8-17 (refer to the Service Position Installation Procedure for extending the A4 board). Set the sweep oscillator to CW, 11.0 GHz, external leveling, and a power level of +20.0 dBm.
3. Press the HP 8349B LINE switch on and allow the equipment to warm up for 30 minutes.
4. Refer to Figure 8-19. A4 Component Locations Diagram. Connect the DVM LO to A4TP4 and DVM HIGH to A4TP3 (INT LEV).
5. Adjust the output power of the RF plug-in until the DVM reads  $1.200 \pm 0.005V$ . This power setting corresponds to an HP 8349B front panel power output display level of 20.0 dBm. Calibrate the power meter and verify both the HP 8349B display and power meter display 20.0 dBm. Refer to the display adjustments in Section 5 if a problem exists at this stage.
6. Probe the points listed in Table 8-2 and verify that the measured voltages correspond to the voltages given in the table. Note that the voltages at the points probed are affected by any A4 signal conditioning board adjustments referenced in Section 5.

Refer to Section 5, A4 signal conditioning board adjustments if the measured voltages do not correspond to the voltages given.

*Table 8-1. A4 Signal Conditioning Board Troubleshooting Voltages*

Measurement Point			Typical Voltage
A4U8 Pin 3	—	A4TP4	−0.50V
A4TP1	—	A4TP2 (INT DET)	−2.50V
A4U5 Pin 3	—	A4TP4	+4.50V
A4TP6	—	A4TP7 (DISP)	+4.50V
A4TP8	—	A4TP9 (DET OUT)	−0.30V

7. Disconnect the 0.5 V/GHz input line (J4) on the rear panel and verify that the COMP output at A4TP5 is 0.00 volts  $\pm 0.010V$ .



## Service Position Installation Procedure

1. Remove the four screws that secure the A4 signal conditioning board to the HP 8349B's center support.
2. Remove the A4 assembly from the A6 motherboard and connect the extender board, HP P/N 08349-60059 to the A6 motherboard and A4 board.
3. Loosen the allen screw on the rear of the center support until the A4 board is aligned. Tighten the allen screw to hold this position.

**NOTE:** Ensure all cable assemblies are still securely fastened after extending the A4 assembly.

4. Reverse this procedure for disassembly.

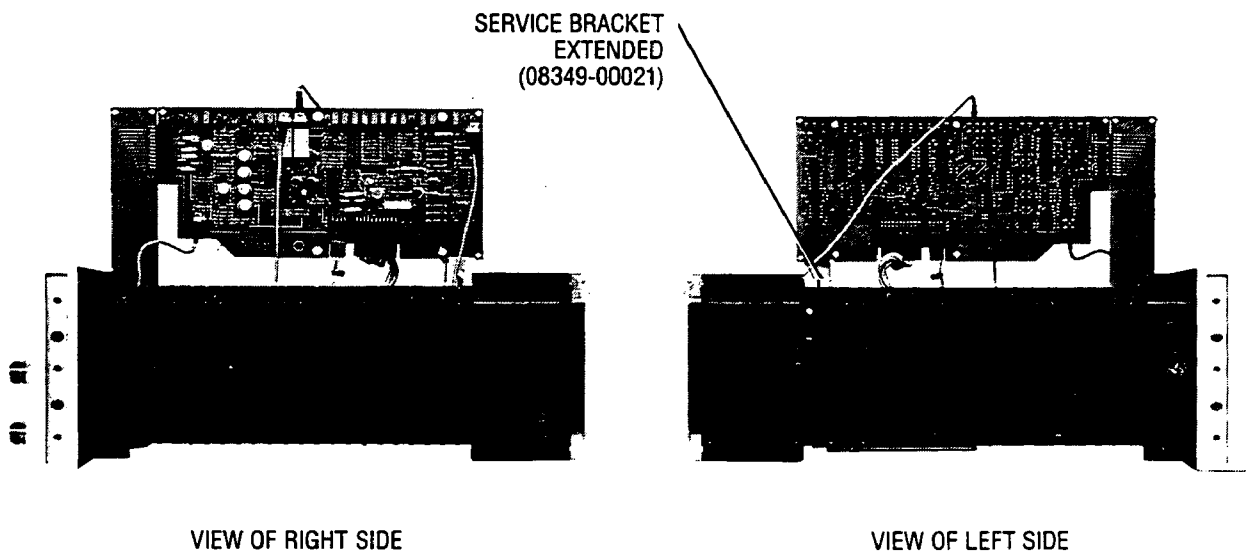

*Figure 8-18. A4 Signal Conditioning Board in Service Position*

A4

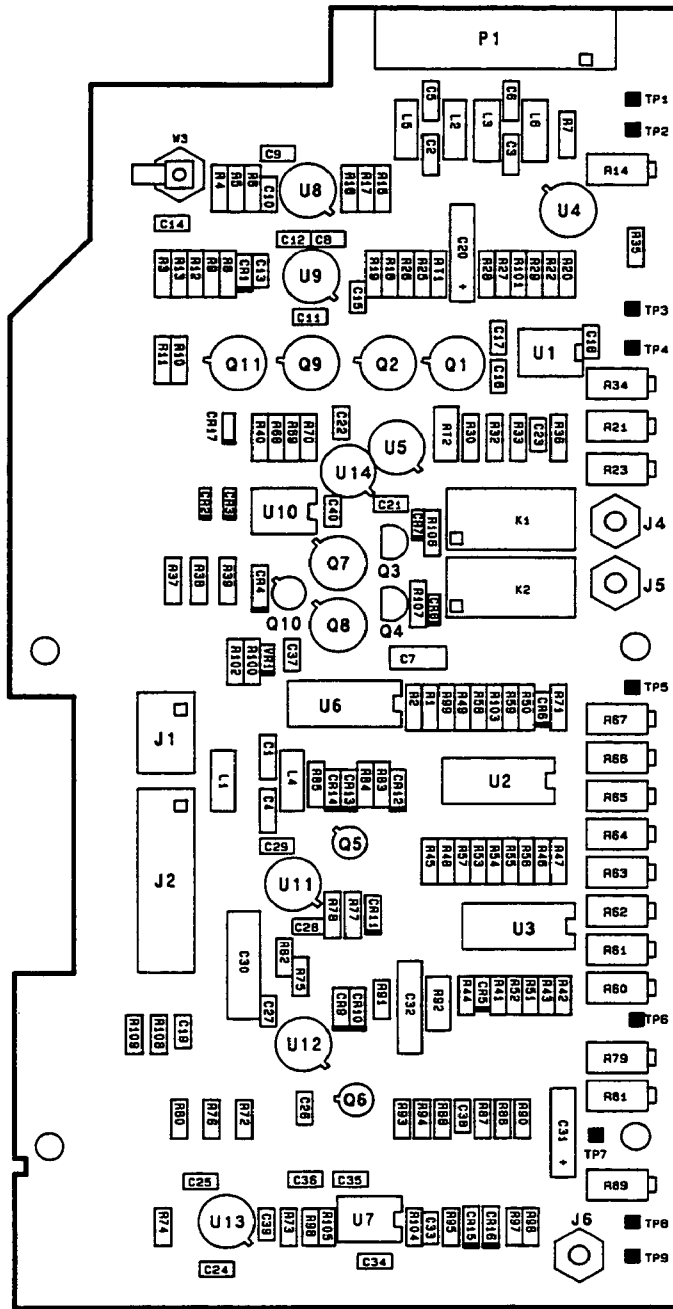

NOTE: Unless otherwise indicated: resistance in ohms ( $\Omega$ ), capacitance in microfarads ( $\mu\text{F}$ ), inductance in microhenries ( $\mu\text{H}$ ).

Figure 8-19. A4 Signal Conditioning, Component Locations Diagram

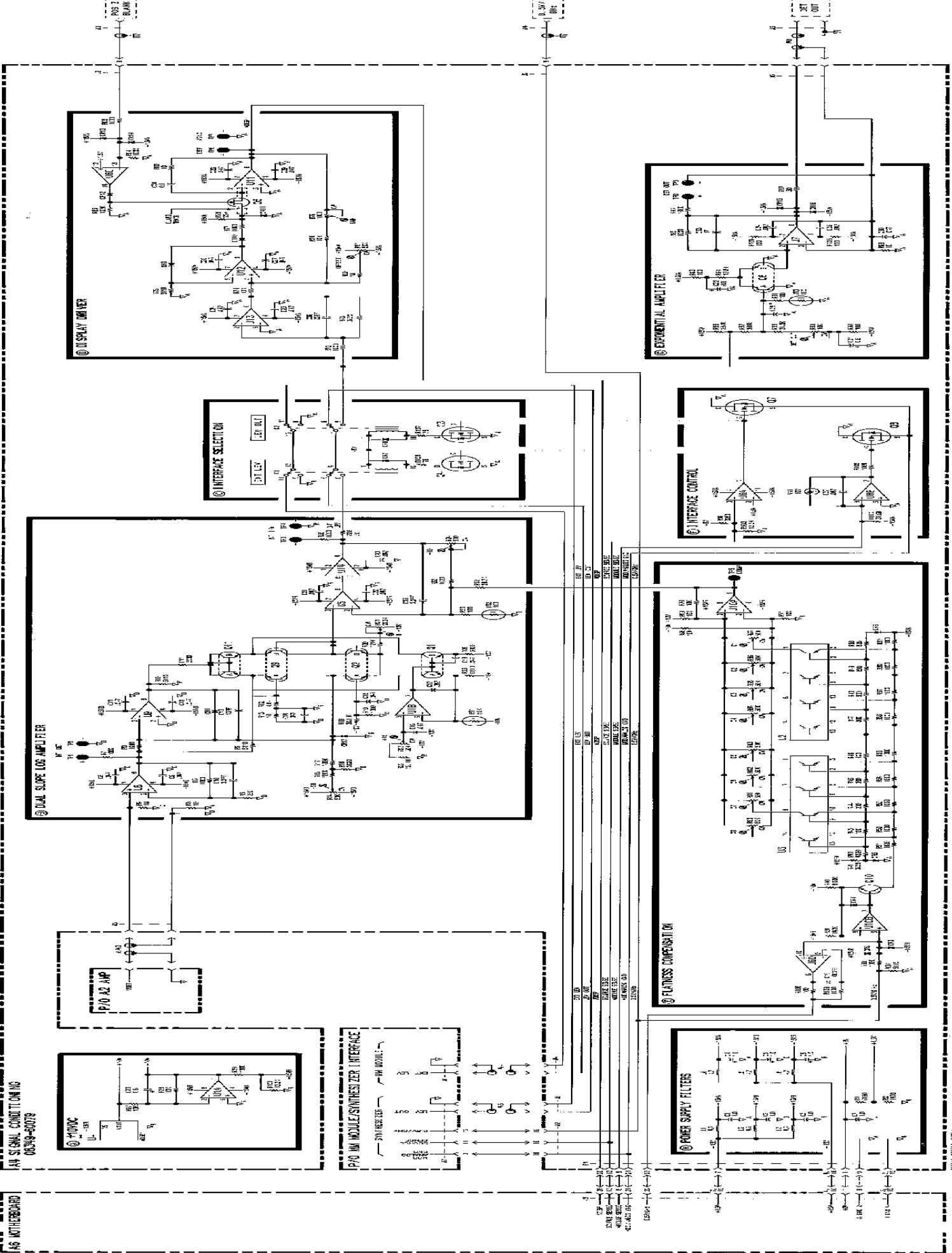

Figure 2-10. AF Signal Conditioning System Circuit Diagram  
68319-60078

## **A5 REGULATOR BOARD, CIRCUIT DESCRIPTION**

**NOTE:** The A5 regulator board schematic documents the power line module, front panel line switch, and transformer, in addition to the A5 assembly itself. The following section applies to chassis mounted parts (not part of A5) associated with the line power circuits.

### **FL1 POWER LINE MODULE, S1 LINE SWITCH, T1 TRANSFORMER**

The Power Line Module includes the primary fuse, line filter, and voltage selector. The fuse, F1, protects the primary side of the transformer against drawing too much current. F1 is accessible from the rear panel. The line filter reduces noise and transients on the line power.

The front panel LINE on/off switch, S1, controls power to the transformer primary. The LINE switch is a plunger style switch with the pushbutton on the front panel and a plunger running back to the rear panel where the switch is located. This type of switch is used to keep the line voltages at the rear panel.

The voltage selector in the Power Line Module configures the instrument to run on 100 Vac, 120 Vac, 220 Vac, or 240 Vac line power. The position of the voltage selector determines which of the various taps of the transformer primary windings are switched in or out. For the procedure on selecting the line voltage and fuse, see Figure 2-1.

**NOTE:** The following sections apply to the A5 regulator board assembly. All reference designators are assumed to be part of A5.

The A5 regulator board provides the regulated power supply voltages for all assemblies in the instrument. There are four independent regulated voltage supplies in all.

**NOTE:** All rectifier circuits on the A5 regulator board assembly are of the same design. While component values change slightly for different voltages, and diode and capacitors change for different polarities, the circuits are essentially identical. The +15V Rectifier is described in detail. For other rectifier description details, refer to "+15 V Rectifier" earlier in this section.

### **BLOCK A - OVER VOLTAGE PROTECTION**

The Over Voltage Protection blows line fuse F1 to protect the instrument from excessive line voltages. If the voltage from the +15 V Rectifier exceeds +31.6 V, Zener diode VR5 conducts, turning SCR Q2 on through R29. Q2 causes excessive current to flow in the transformer and blows line fuse F1. R34 holds Q2 off unless VR5 conducts. C28 prevents fast transients or noise from firing Q2.

### **BLOCK F - +15V RECTIFIER**

CR10, CR11, CR12, and CR13 form a full-wave rectifier for the +15 dc supply. C3 filters the full-wave ripple from the rectifier. C22 is a low impedance path for high frequency pulses. The +15 V Rectifier output is nominally +20 dc before regulation.

## **BLOCK B - +8 V RECTIFIER**

## **BLOCK D - +5 V RECTIFIER**

The +8 V Rectifier and the +5 V Rectifier provide the unregulated voltages for the +8 V Regulator and +5 V Regulator. Their nominal output voltages are as follows:

+8 V Rectifier - +13 V  
+5 V Rectifier - +8 V

**NOTE:** All four regulator circuits on the A5 regulator board assembly are of the same design. While component values change slightly for different polarities, the circuits are essentially identical. The +15 V Regulator is described in detail. For other regulator description details, refer to "+15 V Regulator" earlier in this section.

## **BLOCK G - +15 V REGULATOR**

The 15 V Regulator regulates the +22 dc from the +15 V Rectifier to produce the +15 Vdc power supply voltage. U3 is an adjustable three terminal regulator. Its output voltage is nominally 1.25 dc above the voltage on reference terminal U3 pin 1. R11, R12, and R39 (+15 V Adjust) determines the regulated output voltage. C17 improves power line ripple and noise rejection, and also causes the power supply voltage to rise slowly and without overshoot. Input bypass capacitor C9 reduces high frequency noise or transients into the regulator. C10 reduces noise at the output. CR21 prevents the regulator's output voltage from becoming >0.7 V above the input voltage. CR22 prevents the adjustable terminal voltage from becoming >0.7 V above the regulator's output voltage. CR27 protects the regulator from negative voltages at the output.

The crowbar circuit provides over voltage protection for circuits driven by the +15 V Regulator if U3 or CR21 shorts. If the output voltage rises above +17.8 Vdc, zener diode VR3 conducts and fires SCR Q3 through R27. This shorts the output to ground and blows fuse F7, shutting down the power supply. R32 holds Q5 off unless VR3 conducts. C26 prevents fast transients or noise from firing Q5.

Test point TP3 (+15 V) is available to monitor the output voltage. R23 limits the current if the test point is shorted. LED DS2 turns on when the output voltage is about 12.1 V or greater. VR6 sets the voltage at which DS2 lights. R3 limits the current through DS2. Note that the LED and test point are physically located near each other on the board.

## **BLOCK G - +8 V REGULATOR**

The +8 V Regulator provides the +8 Vdc regulated power supply voltage for the instrument. Besides the change in voltage, there are only three differences between the +8 V Regulator and the +15 V Regulator. The differences are as follows. In the event that U1 or CR17 short, fuse A5F1 will blow, shutting down the supply. When troubleshooting the +8 V power supply, this fuse may be removed to isolate the +8 V Rectifier from the +8 V Regulator. R6, R35, and R7 determine the regulated output voltage. R35 (+8 V ADJ) allows adjustment of the regulated output to exactly +8 V. LED DS4 turns on when the output voltage is approximately 2.0 V or greater.

## **BLOCK E - +5 V REGULATOR**

The +5 V Regulator provides the +5 Vdc power supply voltage for the instrument. Besides the change in voltage, there are only three differences between this regulator and the +15 V Regulator. The differences are as follows. In the event that U2 or CR19 short, fuse F3 will blow, shutting down this supply. When troubleshooting the +5 V power supply, this fuse may be removed to isolate the +5 V Rectifier from the +5 V Regulator. R8, R38, and R10 determine the regulated output voltage. R38 (+5 V ADJ) allows the adjustment of the regulated output to exactly +5 V. LED DS2 turns on when the output voltage is approximately 2.0 V or greater.

## **BLOCK H - 15 V REGULATOR**

The -15 V Regulator provides the -15 Vdc power supply voltage for the instrument. Besides the change in voltage and polarity, there are only three differences between this regulator and the +15 V Regulator. The differences are as follows. In the event that U4 or CR23 short, Fuse F6 will blow, shutting down the supply. When troubleshooting the -15 V power supply, this fuse may be removed to isolate the +15 V Rectifier from the -15 V Regulator. R13, R36, and R14 determine the regulated output voltage. R36 (-15 V ADJ) allows adjustment of the regulated output to exactly -15 V. LED DS4 turns on when the output voltage is approximately -12.1 V or greater.

## **BLOCK I - GROUNDS**

A GND (analog ground) and D GND (digital ground) are referenced to chassis ground through 10 ohm resistors R19 and R20 respectively. The chassis ground connection is made through the standoffs and screws which mount the A5 assembly to the Regulator block and the Regulator Block to the heat sink.

When troubleshooting the A5 regulator board, A2 amplifier assembly, or A3 bias assembly, it is critical that chassis ground be connected.

A GND 1 (analog ground) and A GND 2 are used as the ground for the +15 V, +8 V, and -10 V supplies. These supplies power all the analog circuitry in the instrument. D GND 3 (digital ground) and D GND 4 are used as the ground for the +5 V supply which powers all the digital circuitry. Both A GND 1 and D GND 3 are used for high current applications while A GND 2 and D GND 4 are used for low current. Having independent paths for several grounds improves power supply regulation.

## **A5 REGULATOR BOARD, TROUBLESHOOTING**

**NOTE:** The A5 regulator board schematic documents the power line module, front panel switch, and transformer, in addition to the A5 assembly itself.

**NOTE:** While troubleshooting the A5 regulator board, the chassis ground connection must be maintained. If this assembly needs to be removed from the instrument for troubleshooting, it should be placed into its service position. Refer to the Service Position Installation Procedure below.

## Basic Checks

Check that the rear panel line voltage selector is set for the correct line voltage. Verify that line fuse F1 is not blown and that it is the correct value for the line voltage selected. Check all fuses on the A5 regulator board.

## Transformer

Remove transformer secondary leads connector (P1) from the A5 regulator board. Probe the following pins and verify that the corresponding signals are present.

P1 pins 1 and 2 - +13V p-p (+8 Vdc Supply)  
P1 pins 3 and 4 - +13V p-p (+5 Vdc Supply)  
P1 pins 5 and 6 - +22V p-p (+15 Vdc Supply)

## Rectifiers

Check rectifier outputs for the required voltages. If the voltages are missing or incorrect, suspect the rectifiers. A5F1, A5F3, A5F6, and A5F7 may be removed to isolate the +8 V Rectifier, +5 V Rectifier, -15 V Rectifier, and the +15 V Rectifier, from the respective regulators for troubleshooting. Check that the Over Voltage Protection is not firing.

## Regulators

Check that the voltage difference between the output and regulation (REG) terminals is approximately 1.25 V. These terminals are available at feedthrough holes (not test points) on the A5 regulator board. Verify that Crowbar circuitry has not fired.

To eliminate the possibility of other assemblies in the HP 8349B loading down the supply voltages, remove major assemblies from their connectors, or disconnect the A5 regulator board from A6J4 (physical connection of A5 board to heat sink to rear panel must be maintained to ensure chassis ground connection).

Table 8-2. Power Supply Voltages and Tolerances

Block	Power Supply Output	Nominal Voltage (V)	Allowable Range (V)	Maximum Current Drain (A)	Assemblies Where Used
F	+15 V UNREG	±22	18-24	—	A5
B	+8 V UNREG	13	11-15.7	—	A5
D	+5 V UNREG	13	8-11.2	—	A5
G	+15 V	15	14.8-15.2	0.1	A4, A5
C	+8 V	8	7.9-9.3	1.0	A1, A2, A3, A4, A5
E	+5 V	5	5-5.6	0.3	A1, A5
H	-15 V	-15	14.8-15.2	0.1	A1, A2, A3, A4, A5

## Service Position Installation Procedure

1. Turn the HP 8349B LINE switch off and disconnect the line cord.
2. Remove the top and bottom covers (only the rear screw on the top needs to be removed to remove the top cover).
3. Remove the four screws securing the heat sink on which the A5 regulator board is mounted (see Figure 8-21a).
4. Remove the rear two screws securing the heat sink on which the A2 amplifier and A3 bias board are mounted (see Figure 8-21b).
5. Loosen the two screws securing the center support of the HP 8349B (see Figure 8-21c). Slide the rear panel away from the front panel.
6. Disengage the A5 regulator board from the motherboard and disconnect the transformer's secondary leads connector P1 from A5J1. Remove the A5 assembly and heat sink from the instrument.

**NOTE:** When sliding the rear panel forward in step 7, ensure that the LINE switch is reinserted through the front panel.

7. Slide the rear panel toward the front panel and reinstall the rear two screws which secure the heat sink on which the A2 and A3 assemblies are mounted. Securing this heat sink to the rear panel reconnects chassis ground.
8. Connect the extender board, HP P/N 08349-60059, to A6J4.
9. Mount the extender bracket (HP P/N 08349-00005) to the front panel using two of the screws removed in step 3. Connect the A5 regulator board to the extender board installed in step 8 and mount the heat sink to the extender bracket (see Figure 8-21d).
10. Reinstall the transformer's secondary leads connector P1 to A5J1. Ensure the LINE switch is off before reconnecting the LINE cord.
11. Reverse this procedure when reinstalling the A5 regulator board and heat sink.



**RIGHT SIDE**

**REMOVE FOUR SCREWS**

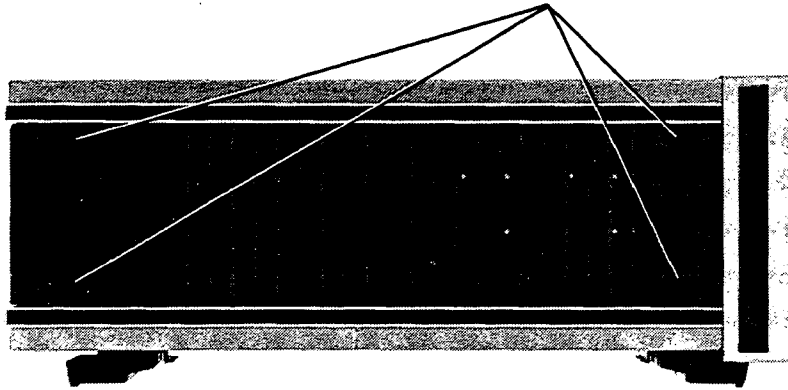

**LEFT SIDE**

**REMOVE TWO SCREWS**

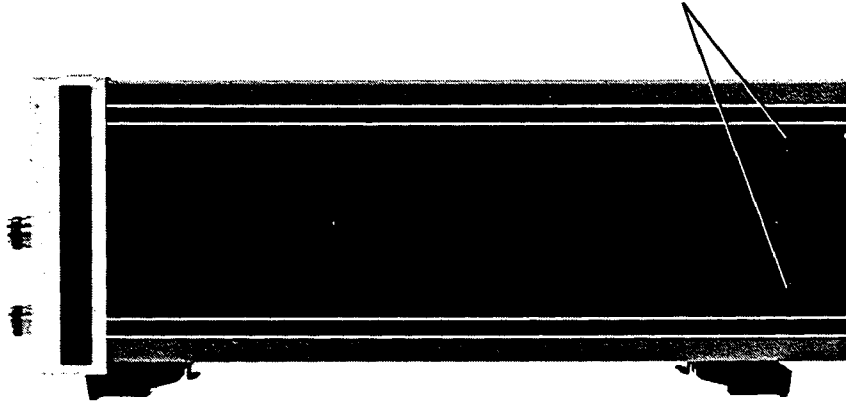

*Figure 8-21. Service Position Installation (1 of 2)*

**TOP VIEW**

**LOOSEN TOP AND BOTTOM SCREWS**  
(bottom screw not visible)

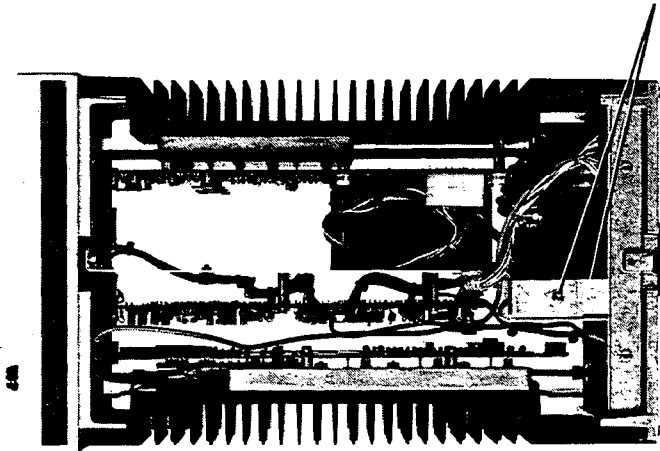

**A5 REGULATOR BOARD AND HEAT SINK IN SERVICE POSITION**

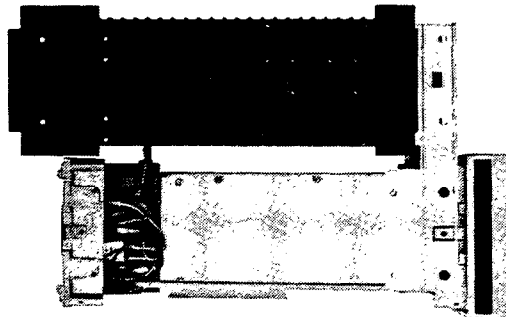

**VIEW OF LEFT SIDE**

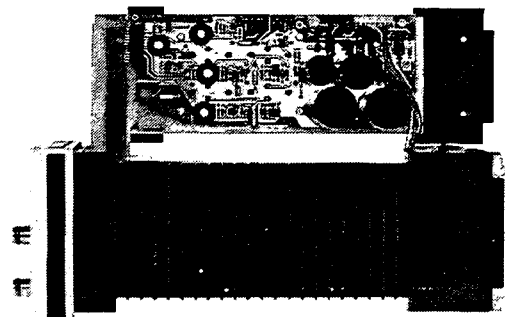

**VIEW OF RIGHT SIDE**

*Figure 8-21. Service Position Installation (2 of 2)*

# A5

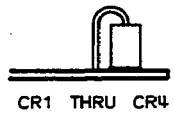
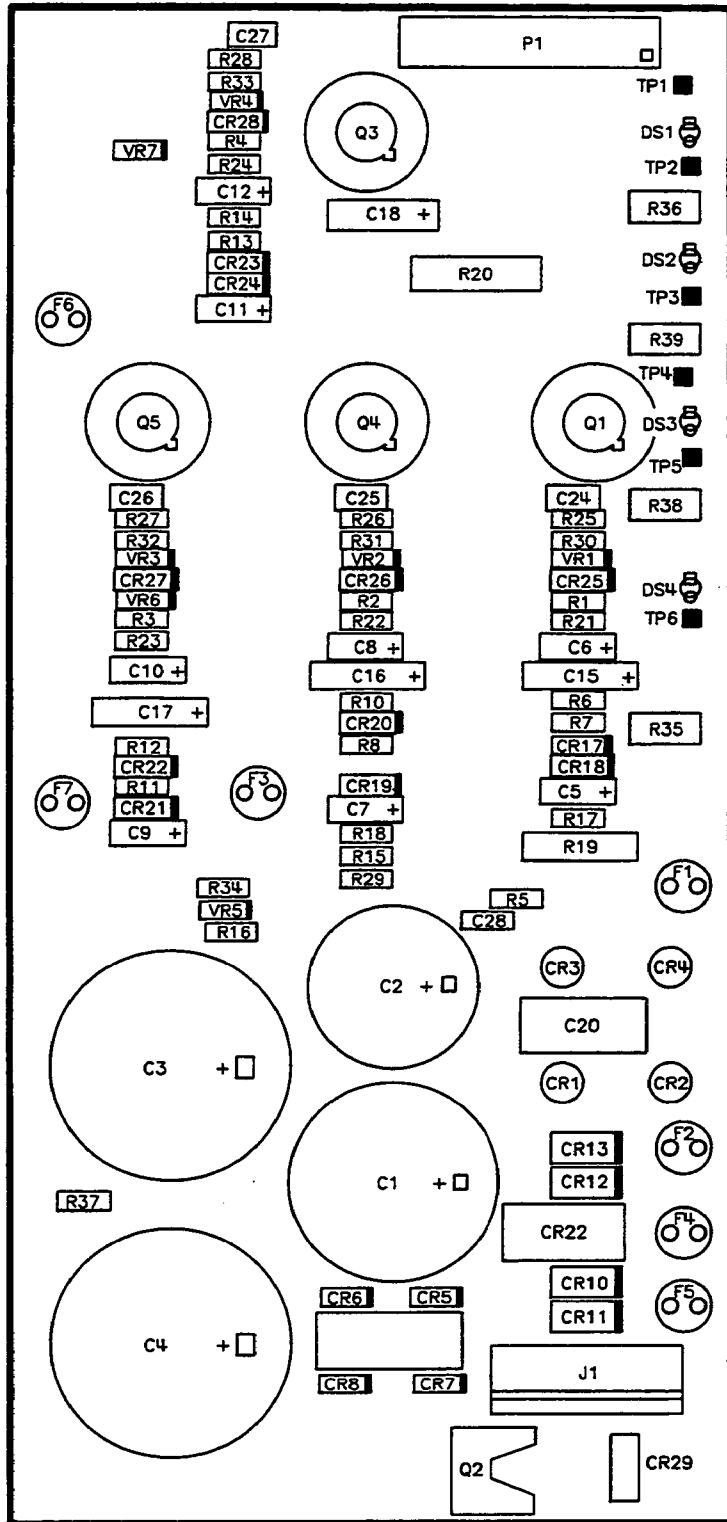

Figure 8-22. A5 Regulator, Component Locations Diagram



## **A6 MOTHERBOARD**

The A6 motherboard interconnects all the major assemblies in the HP 8349B. Refer to the Overall Block Diagram for a diagram of the connections between the motherboard and the rest of the instrument.

### **MODULE/SYNTHESIZER INTERFACE INTERCONNECTION DESCRIPTION**

The Module/Synthesizer Interface provides the necessary power supply voltages and control lines when using a millimeter source module during millimeter-wave applications.

The majority of control lines (both analog and digital) are transparent to the HP 8349B. The lines pass directly through the amplifier from the module interface connector J6 to the synthesizer interface connector J7. See Figure 8-25.

The module interface connector (J6) provides the necessary power supply operating voltages ( $\pm 15$  V, +8 V, and +5 V) to the source module for both analog and digital circuits. These voltages are supplied from the A5 Regulator assembly in the HP 8349B.

An EXT LEV -- ALC signal from the source module is routed to the HP 8349B through the coaxial cable in the center of the Module Interface connector J6. The signal is then routed through the A4 Signal Conditioning Board to one of two places depending on what type of RF source is connected to the amplifier. If a synthesizer is connected to the Synthesizer Interface connector the EXT LEV (Logged ALC Signal) is routed directly to the center coaxial cable in the Synthesizer Interface connector J7. This LEV OUT signal goes to the synthesizer for processing to provide leveled output power at the RF output of the source module. If a synthesizer is not being used, the EXT LEV signal is processed through an exponential circuit on the A4 Signal Conditioning Board to provide a linear output signal (DET OUT) on the rear panel (BNC connector J5) of the HP 8349B.

The control lines for the EXT LEV and LEV OUT signals are provided in the connectors J6 and J7. Module sense is normally pulled down. When the source module is connected to J6, module sense becomes high de-energizing a relay on the A4 assembly for signal routing. Source sense is a normally pulled up signal. When the RF source connection is made, the line is pulled low and de-energizes a relay on the Q4 assembly for routing. See the service section for the A4 Signal Conditioning Board concerning circuit details.

### **INTERFACE TROUBLESHOOTING**

Check proper supply voltages on the Module Interface connector J6. Continuity checks on the remaining control lines can be made with a DVM from J6 to J7.

The ALC signals and routing can be checked by connecting a source module or synthesizer to the HP 8349B to ensure correct signal routing. If a module or synthesizer are not available, the EXT LEV signal can be checked by connecting the module sense control line (J6-11) to a TTL high level (J6-7). The LEV OUT signal can be checked by connecting the source sense control line (J7-11) to a TTL low level (J7-17). A continuity check can be made with both control lines activated. If continuity is not made, refer to the service section on the A4 Signal Conditioning Board troubleshooting.

A6

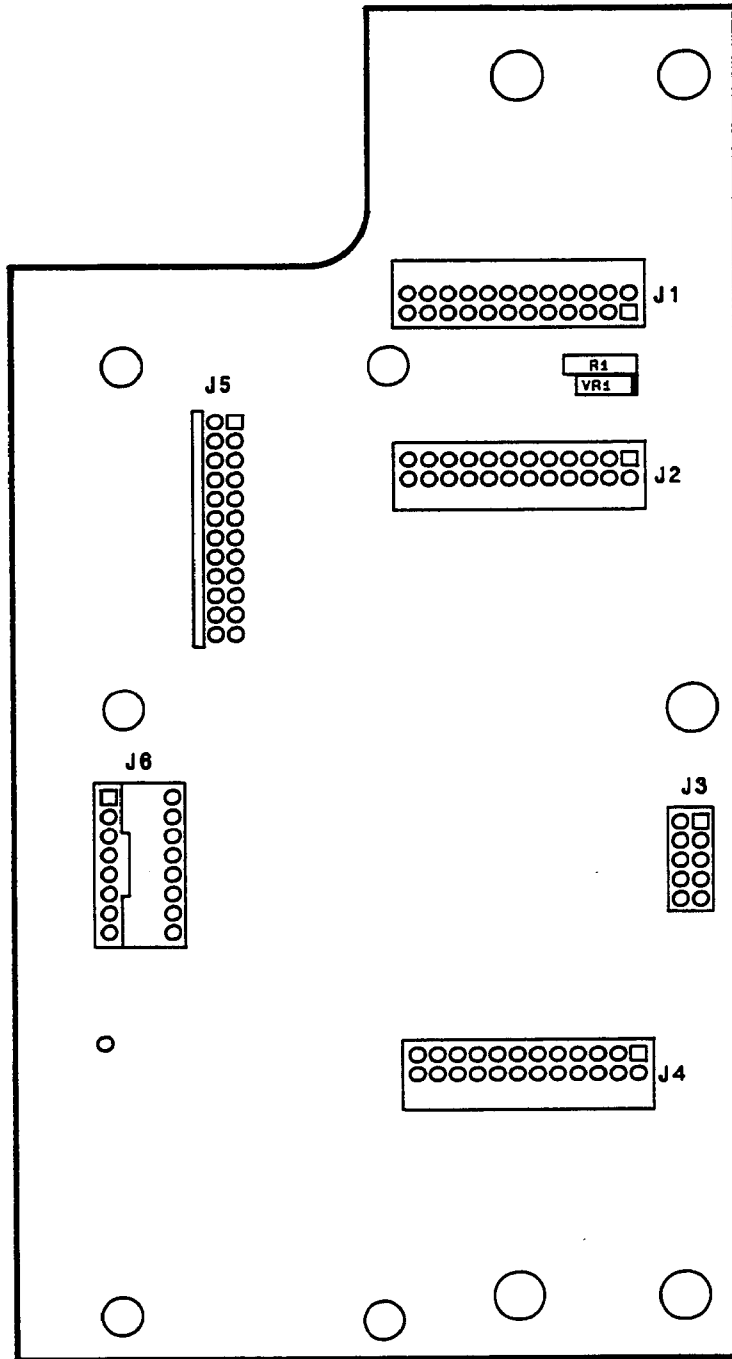
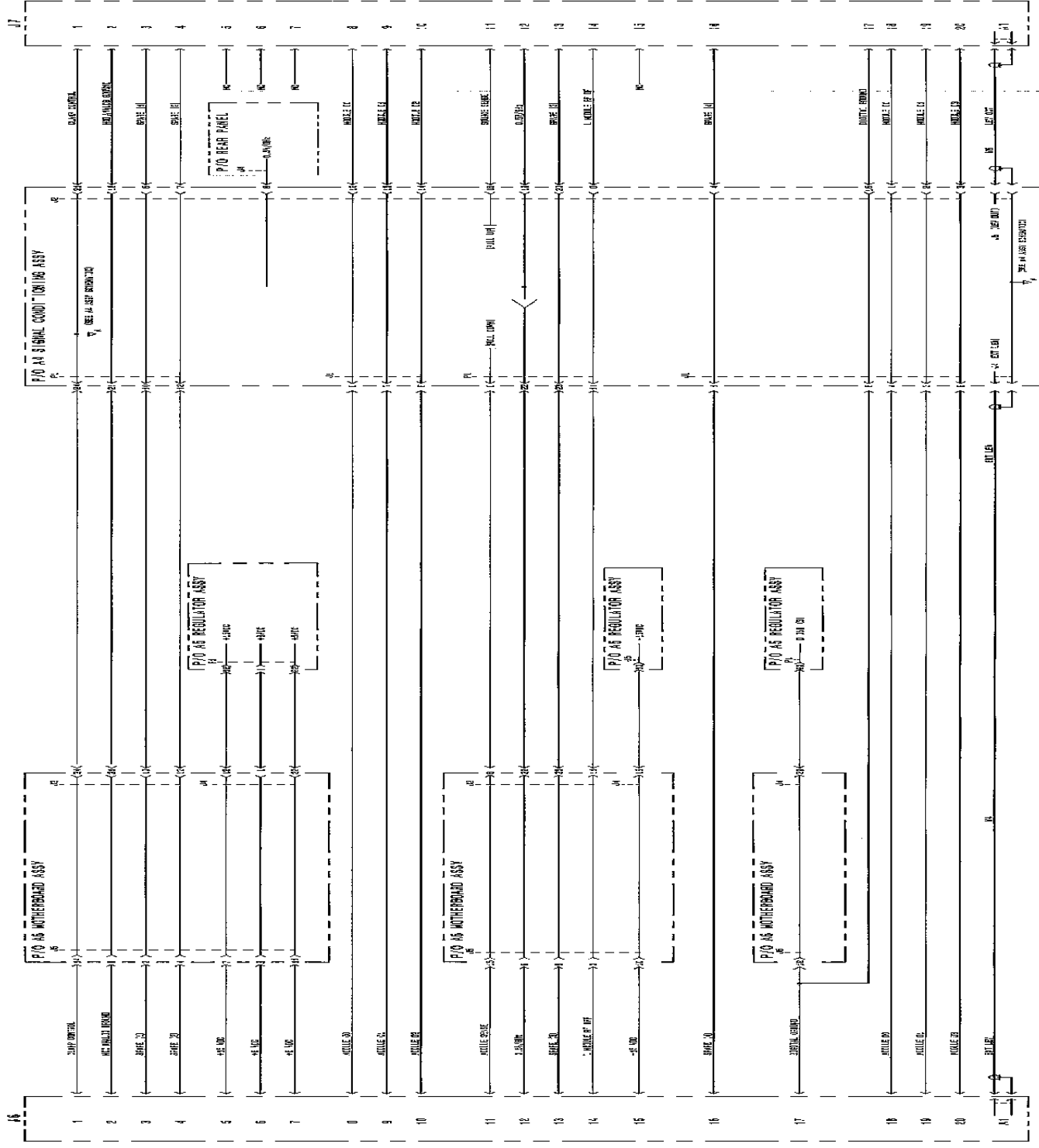

Figure 8-24. A6 Motherboard, Component Locations Diagram

MODULE INTERFACE PLUG  
 1 2 3 4 5 6 7 8  
 00000 H 00000  
 00000 00000  
 FEMALE CONNECTOR  
 - FRONT VIEW



MODULE INTERFACE PLUG  
 1 2 3 4 5 6 7 8  
 00000 H 00000  
 00000 00000  
 FEMALE CONNECTOR  
 - FRONT VIEW

**FRONT VIEW**

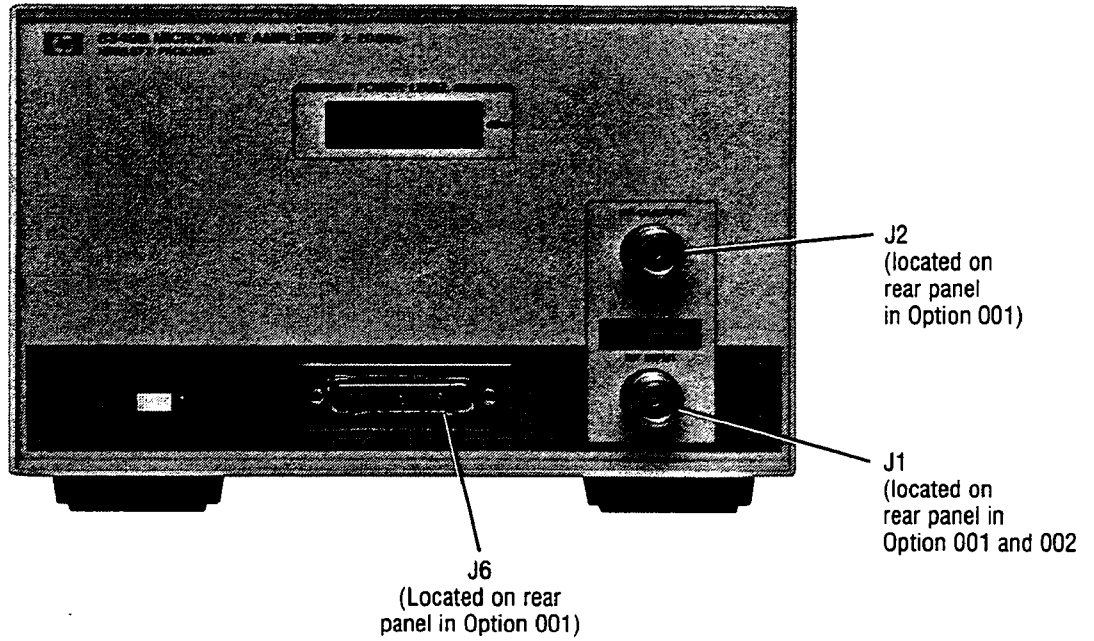

**REAR VIEW**

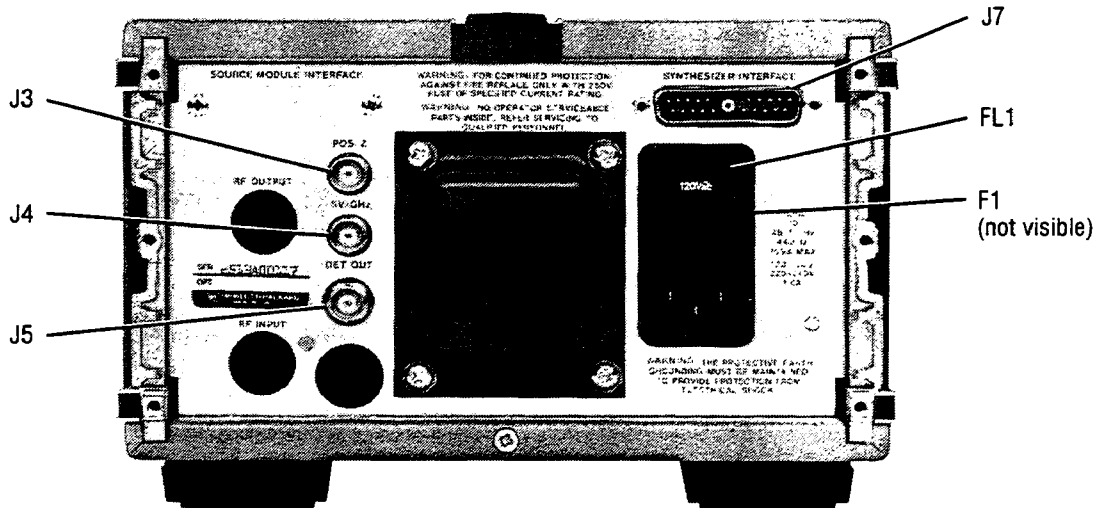
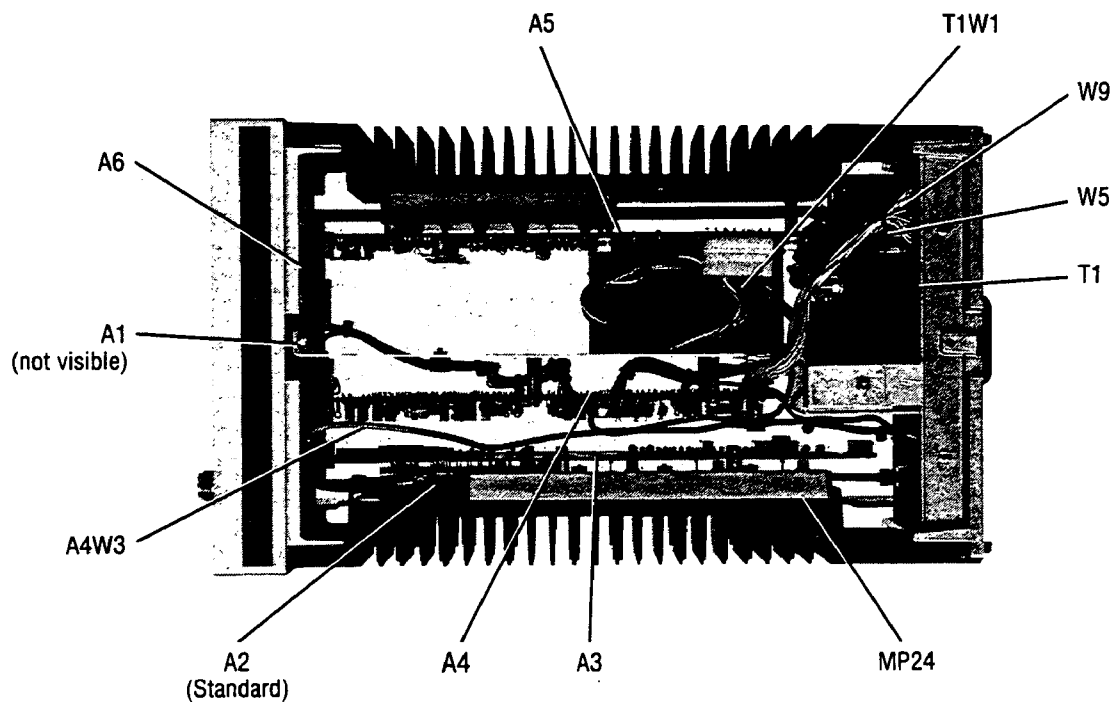

Figure 8-26. Major Assemblies (1 of 3)



TOP VIEW WITHOUT COVERS



BOTTOM VIEW WITHOUT COVERS

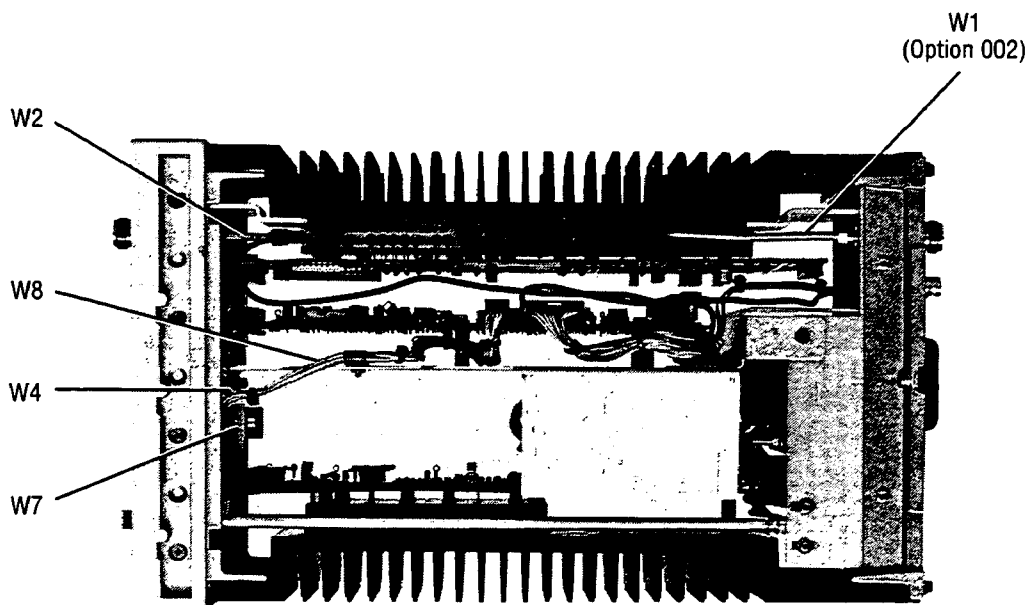

Figure 8-26. Major Assemblies (2 of 3)

INSIDE REAR PANEL

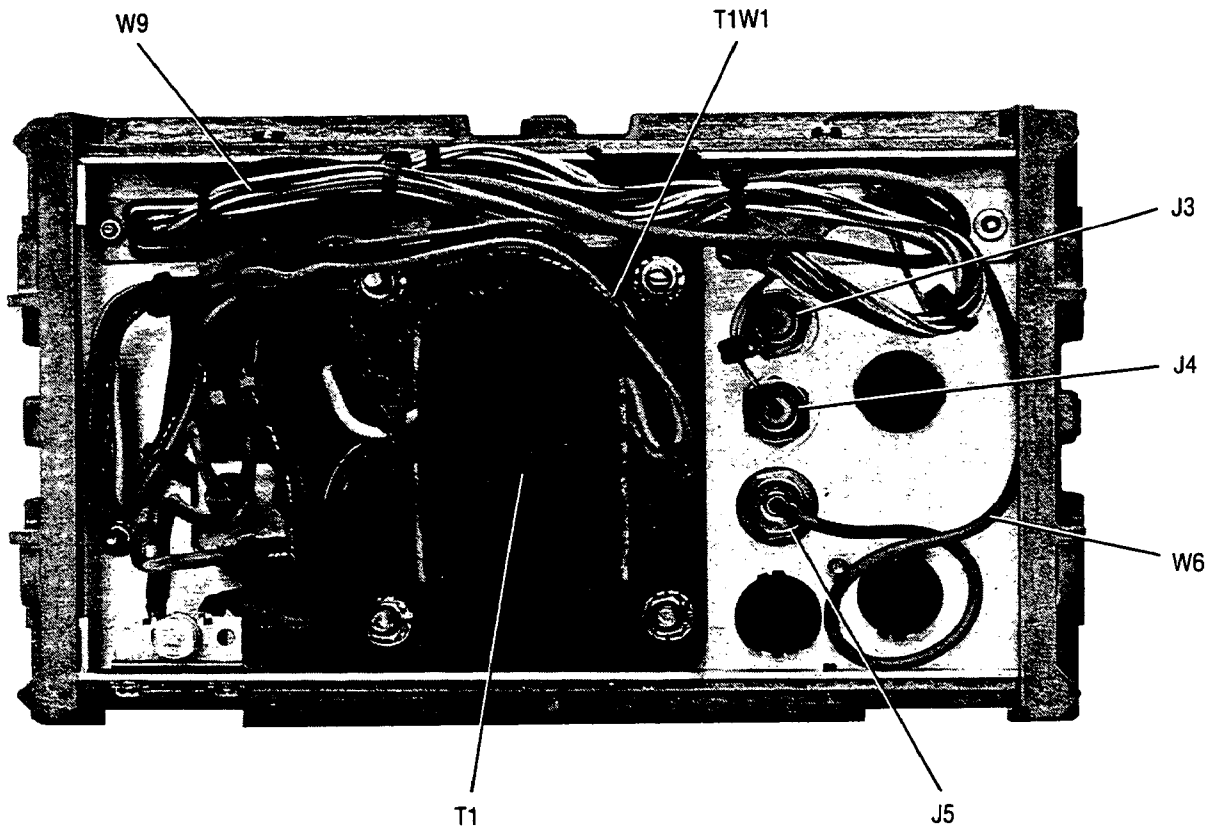

Figure 8-26. Major Assemblies (3 of 3)